

User Manual

Revision 1.100
English

Modbus Master / SNMP Agent - Converter

(Order Code: HD67164-232-A1, HD67164-485-A1, HD67164-422-A1, HD67164-232-485-A1, HD67164-232-422-A1, HD67164-232-B2, HD67164-485-B2, HD67164-232-485-B2)

for Website information:

www.adfweb.com?Product=HD67164

for Price information:

- www.adfweb.com?Price=HD67164-232-A1
- www.adfweb.com?Price=HD67164-485-A1
- www.adfweb.com?Price=HD67164-422-A1
- www.adfweb.com?Price=HD67164-232-485-A1
- www.adfweb.com?Price=HD67164-232-422-A1
- www.adfweb.com?Price=HD67164-232-B2
- www.adfweb.com?Price=HD67164-485-B2
- www.adfweb.com?Price=HD67164-232-485-B2

Benefits and Main Features:

- ⊕ Very easy to configure
- ⊕ Electrical isolation
- ⊕ Temperature range: -40°C/85°C (-40°F/185°F)



User Manual

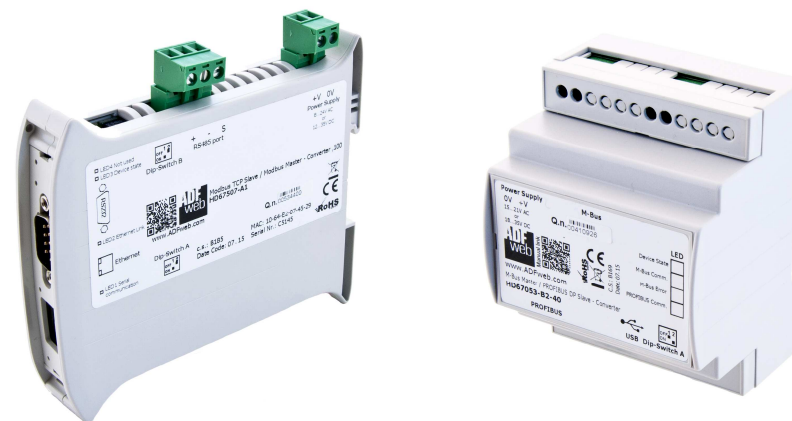

For others SNMP products, see also the following links:

Converter SNMP to

- www.adfweb.com?Product=HD67040
- www.adfweb.com?Product=HD67092
- www.adfweb.com?Product=HD67155
- www.adfweb.com?Product=HD67156
- www.adfweb.com?Product=HD67159
- www.adfweb.com?Product=HD67160
- www.adfweb.com?Product=HD67161
- www.adfweb.com?Product=HD67162
- www.adfweb.com?Product=HD67163
- www.adfweb.com?Product=HD67165
- www.adfweb.com?Product=HD67166
- www.adfweb.com?Product=HD67167
- www.adfweb.com?Product=HD67168
- www.adfweb.com?Product=HD67169
- www.adfweb.com?Product=HD67613
- www.adfweb.com?Product=HD67693
- www.adfweb.com?Product=HD67726
- www.adfweb.com?Product=HD67820
- www.adfweb.com?Product=HD67850

- (DMX)**
- (M-Bus Wireless)**
- (CAN)**
- (CANopen)**
- (EtherNet/IP)**
- (DeviceNet Master)**
- (DeviceNet Slave)**
- (J1939)**
- (M-Bus Master)**
- (Modbus Slave)**
- (Modbus TCP Master)**
- (Modbus TCP Slave)**
- (PROFIBUS Master)**
- (PROFIBUS Slave)**
- (PROFINET)**
- (BACnet Slave)**
- (BACnet Master)**
- (KNX)**
- (DALI)**

Do you have an your customer protocol?

www.adfweb.com?Product=HD67003

Do you need to choose a device? do you want help?

www.adfweb.com?Cmd=helpme

INDEX:

	Page
INDEX	2
UPDATED DOCUMENTATION	2
REVISION LIST	2
WARNING	2
TRADEMARKS	2
SECURITY ALERT	3
EXAMPLE OF CONNECTION	4
CONNECTION SCHEME	5
CHARACTERISTICS	13
CONFIGURATION	13
POWER SUPPLY	14
FUNCTION MODES	15
LEDS	16
SNMP	17
RS232	17
RS485	18
RS422	19
USE OF COMPOSITOR SW67164	20
NEW PROJECT / OPEN PROJECT	21
SOFTWARE OPTIONS	22
SET COMMUNICATION	23
SET ACCESS	24
SET SNMP ACCESS	26
MIB FILE	27
UPDATE DEVICE	28
SNMP COMMUNICATION (DYNAMIC MAP)	30
SNMP COMMUNICATION (FIXED MAP)	35
MECHANICAL DIMENSIONS	38
ORDERING INFORMATIONS	39
ACCESSORIES	40
DISCLAIMER	41
OTHER REGULATIONS AND STANDARDS	41
WARRANTIES AND TECHNICAL SUPPORT	42
RETURN POLICY	42

UPDATED DOCUMENTATION:

Dear customer, we thank you for your attention and we remind you that you need to check that the following document is:

- ✚ Updated
- ✚ Related to the product you own

To obtain the most recently updated document, note the “document code” that appears at the top right-hand corner of each page of this document.

With this “Document Code” go to web page www.adfweb.com/download/ and search for the corresponding code on the page. Click on the proper “Document Code” and download the updates.

REVISION LIST:

Revision	Date	Author	Chapter	Description
1.001	05/10/2015	Ff	All	Added new feature
1.002	11/01/2016	Nt	All	Revision
1.003	25/01/2016	Ff	All	New functioning of LEDs
1.100	15/05/2017	Ff	All	New SNMP function

WARNING:

ADFweb.com reserves the right to change information in this manual about our product without warning. ADFweb.com is not responsible for any error this manual may contain.

TRADEMARKS:

All trademarks mentioned in this document belong to their respective owners.

SECURITY ALERT:**GENERAL INFORMATION**

To ensure safe operation, the device must be operated according to the instructions in the manual. When using the device, legal and safety regulation are required for each individual application. The same applies also when using accessories.

INTENDED USE

Machines and systems must be designed so the faulty conditions do not lead to a dangerous situation for the operator (i.e. independent limit switches, mechanical interlocks, etc.).

QUALIFIED PERSONNEL

The device can be used only by qualified personnel, strictly in accordance with the specifications.

Qualified personnel are persons who are familiar with the installation, assembly, commissioning and operation of this equipment and who have appropriate qualifications for their job.

RESIDUAL RISKS

The device is state-of-the-art and is safe. The instruments can represent a potential hazard if they are inappropriately installed and operated by untrained personnel. These instructions refer to residual risks with the following symbol:



This symbol indicates that non-observance of the safety instructions is a danger for people that could lead to serious injury or death and / or the possibility of damage.

CE CONFORMITY

The declaration is made by our company. You can send an email to support@adfweb.com or give us a call if you need it.

EXAMPLE OF CONNECTION:

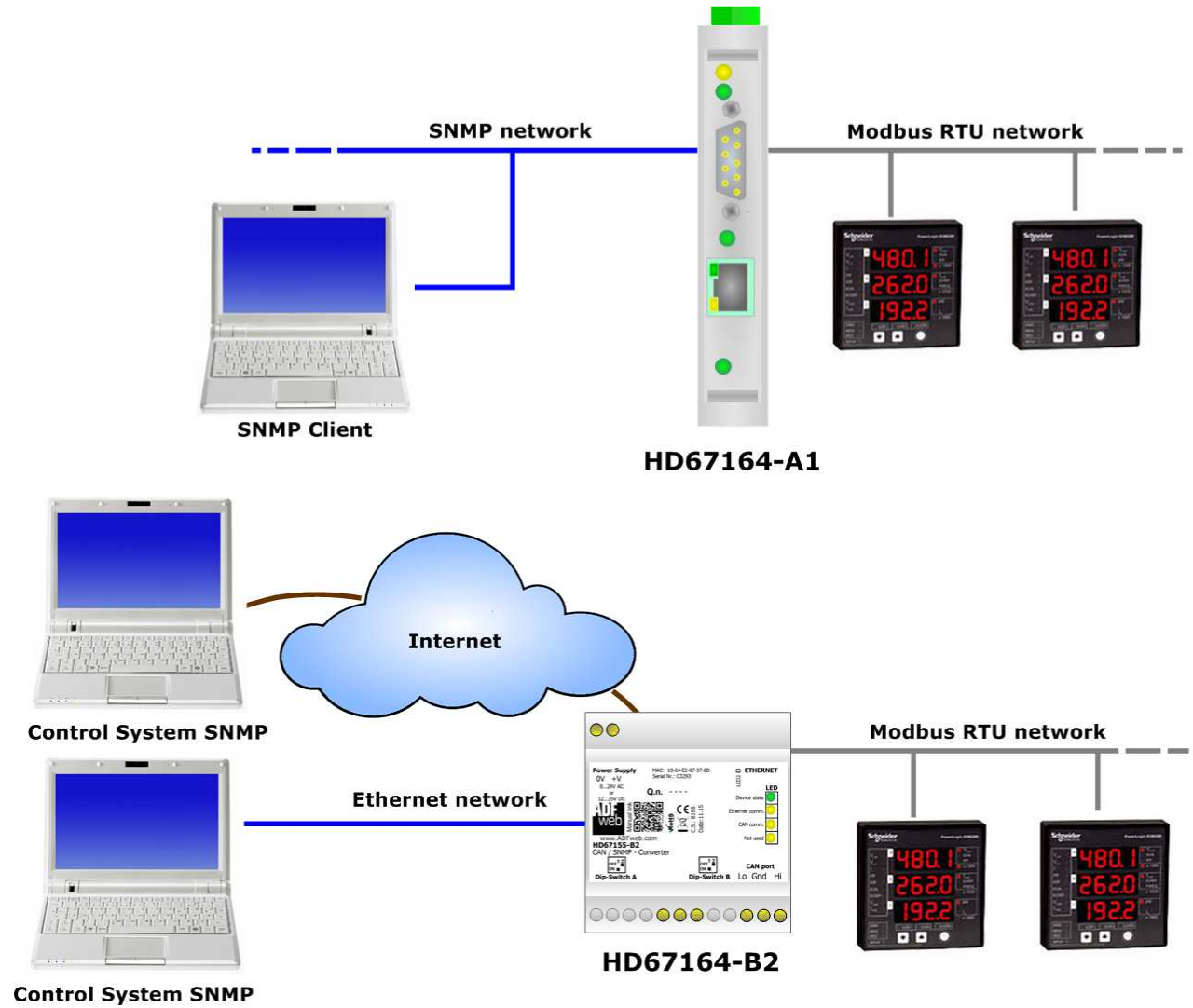

CONNECTION SCHEME:

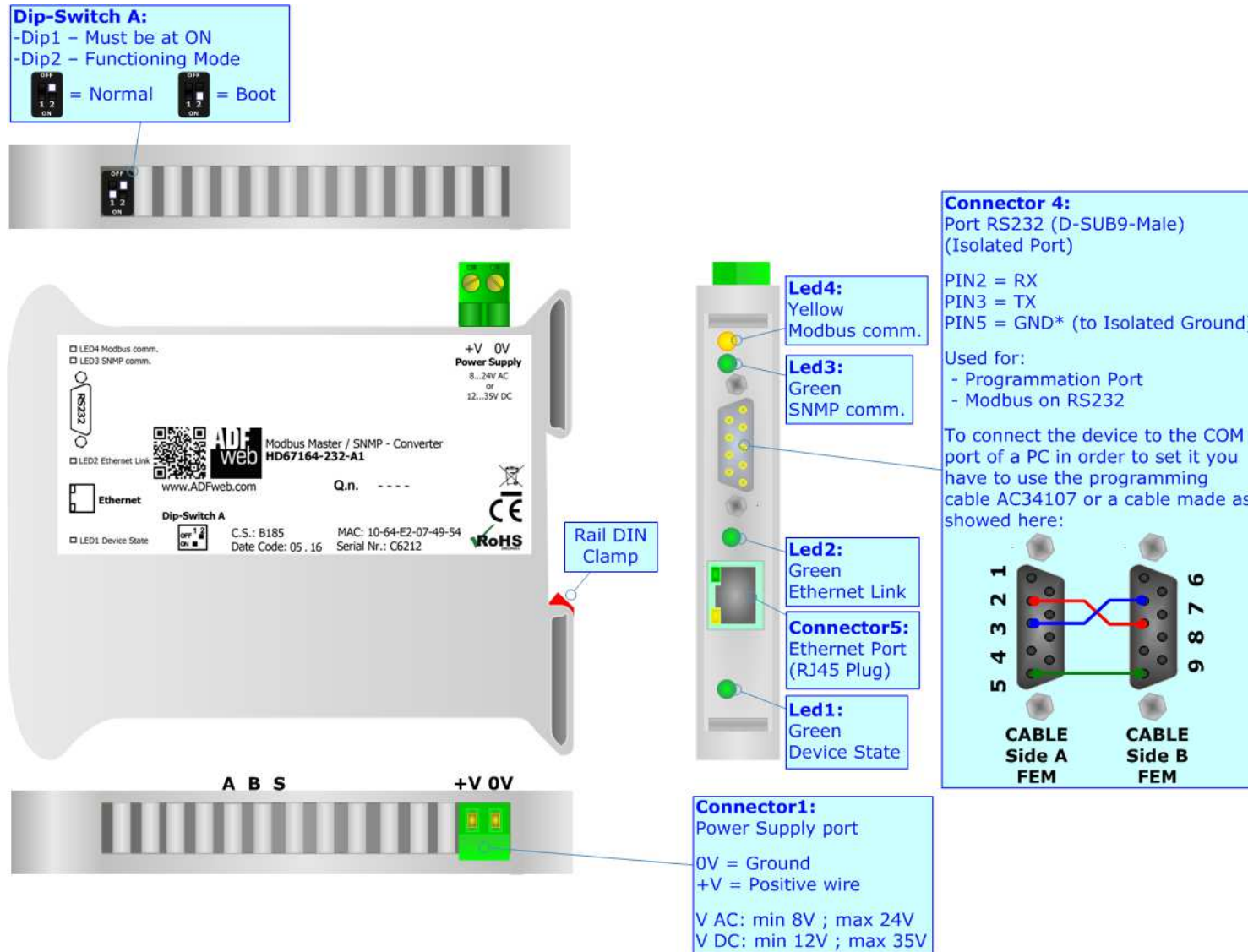

Figure 1a: Connection scheme for HD67164-232-A1

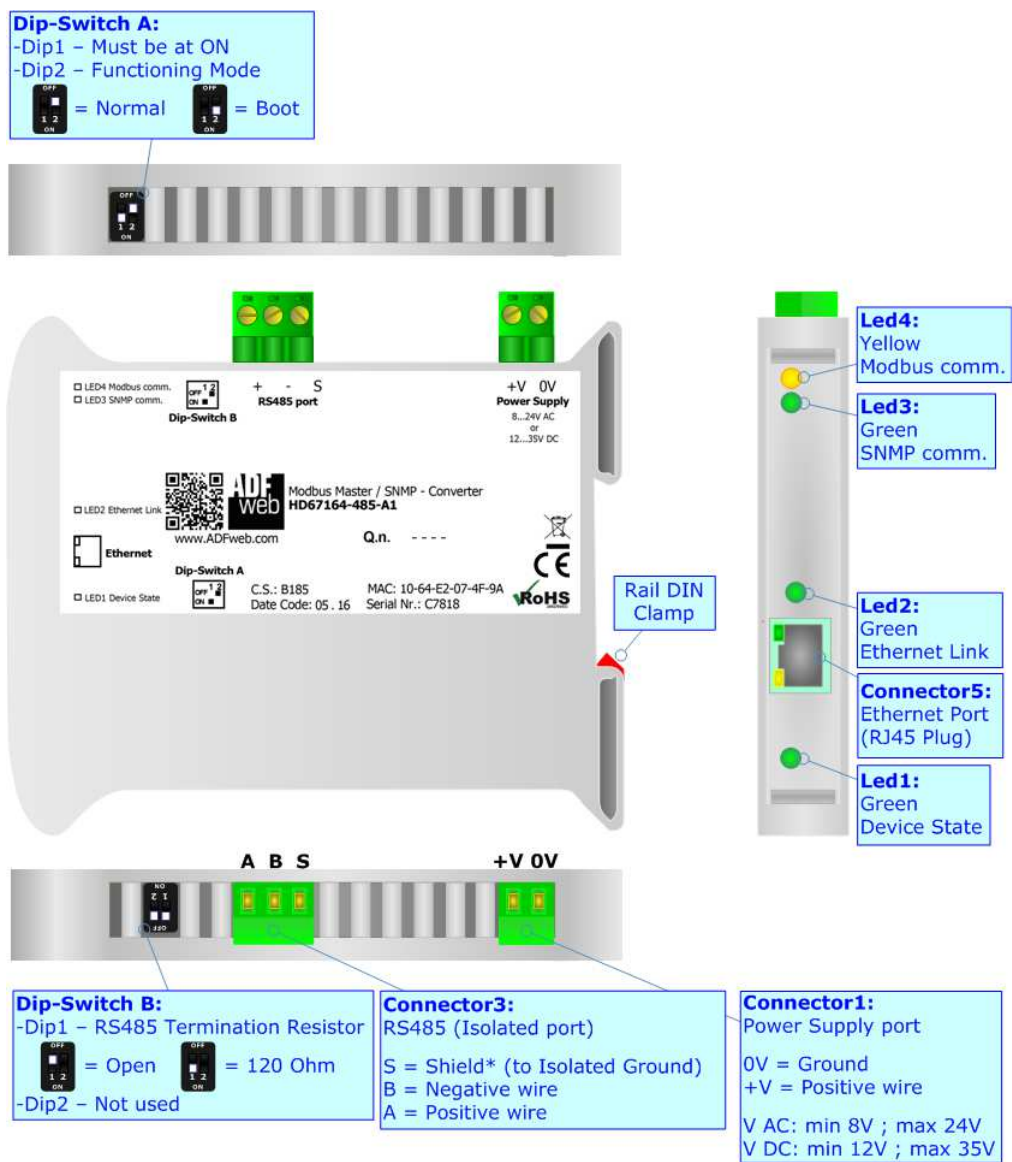

Figure 1b: Connection scheme for HD67164-485-A1

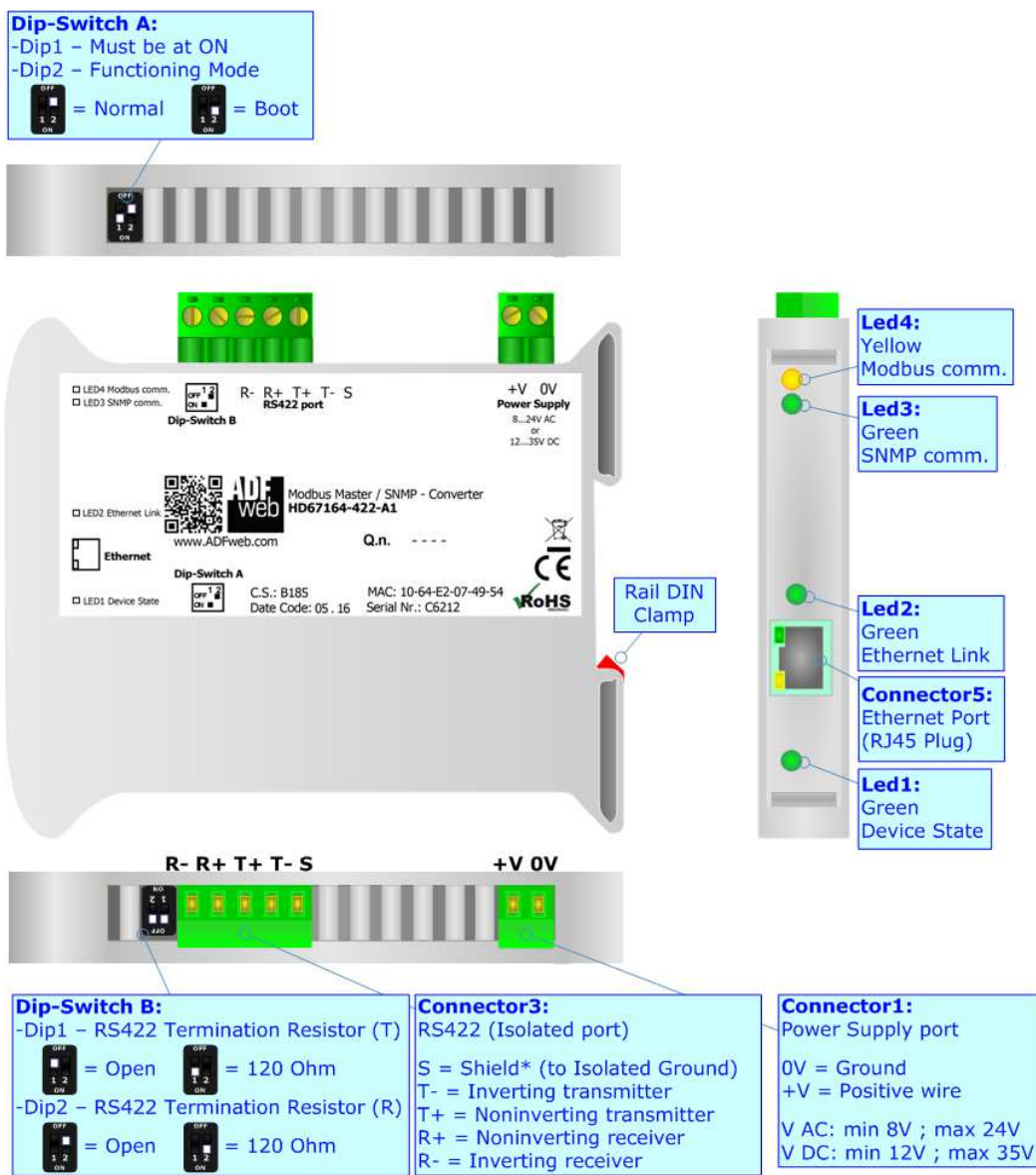

Figure 1c: Connection scheme for HD67164-422-A1

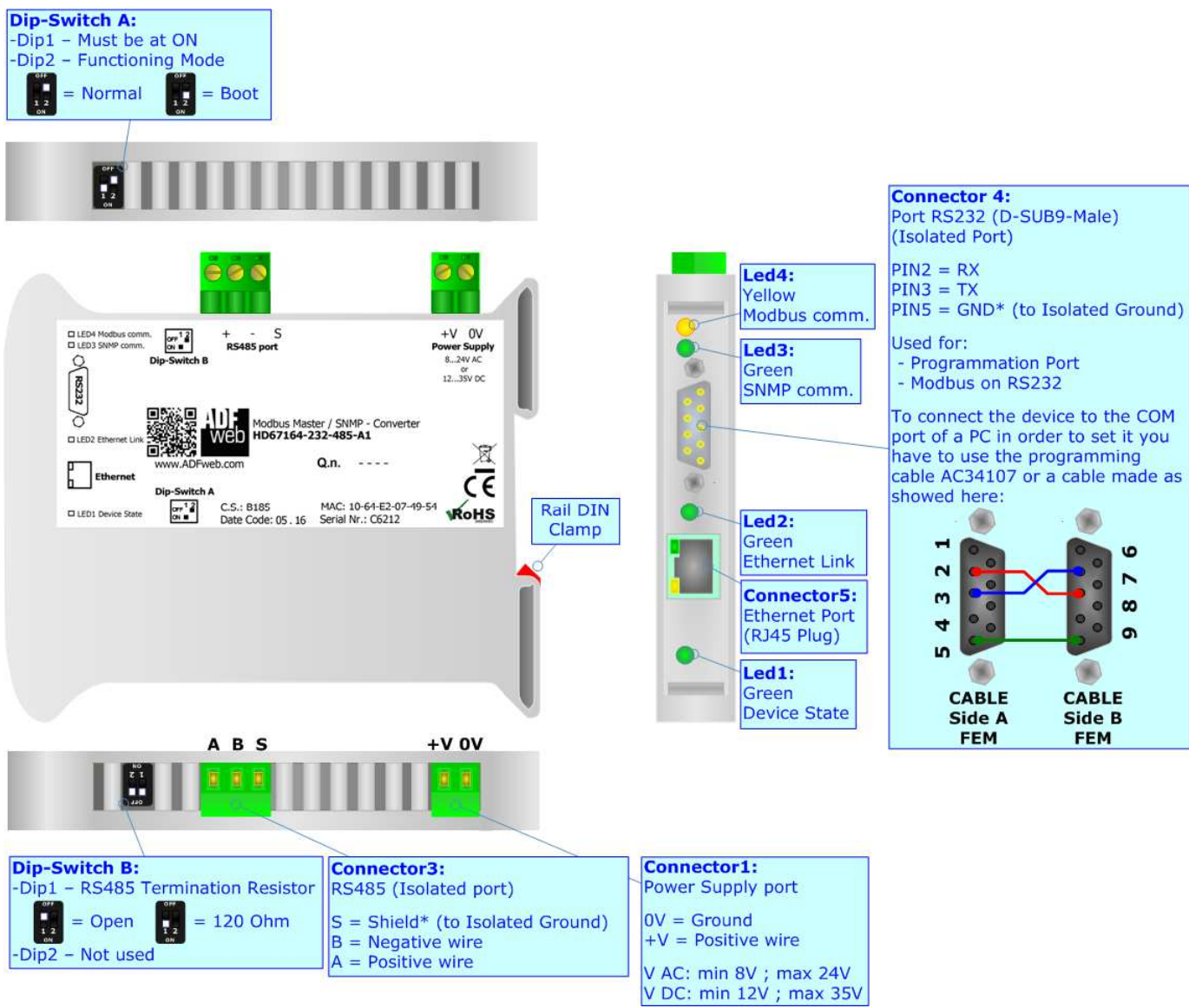

Figure 1d: Connection scheme for HD67164-232-485-A1

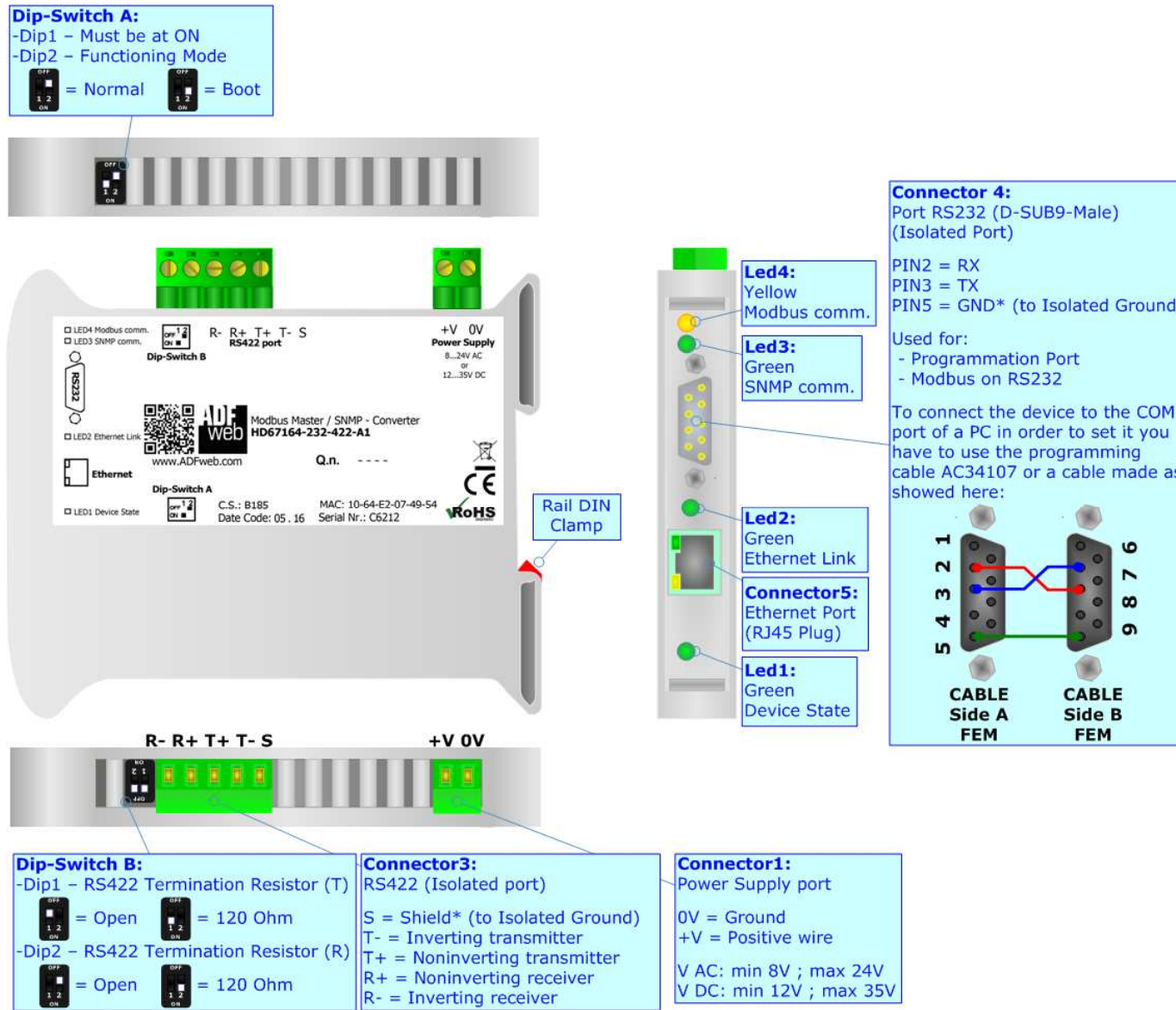

Figure 1e: Connection scheme for HD67164-232-422-A1

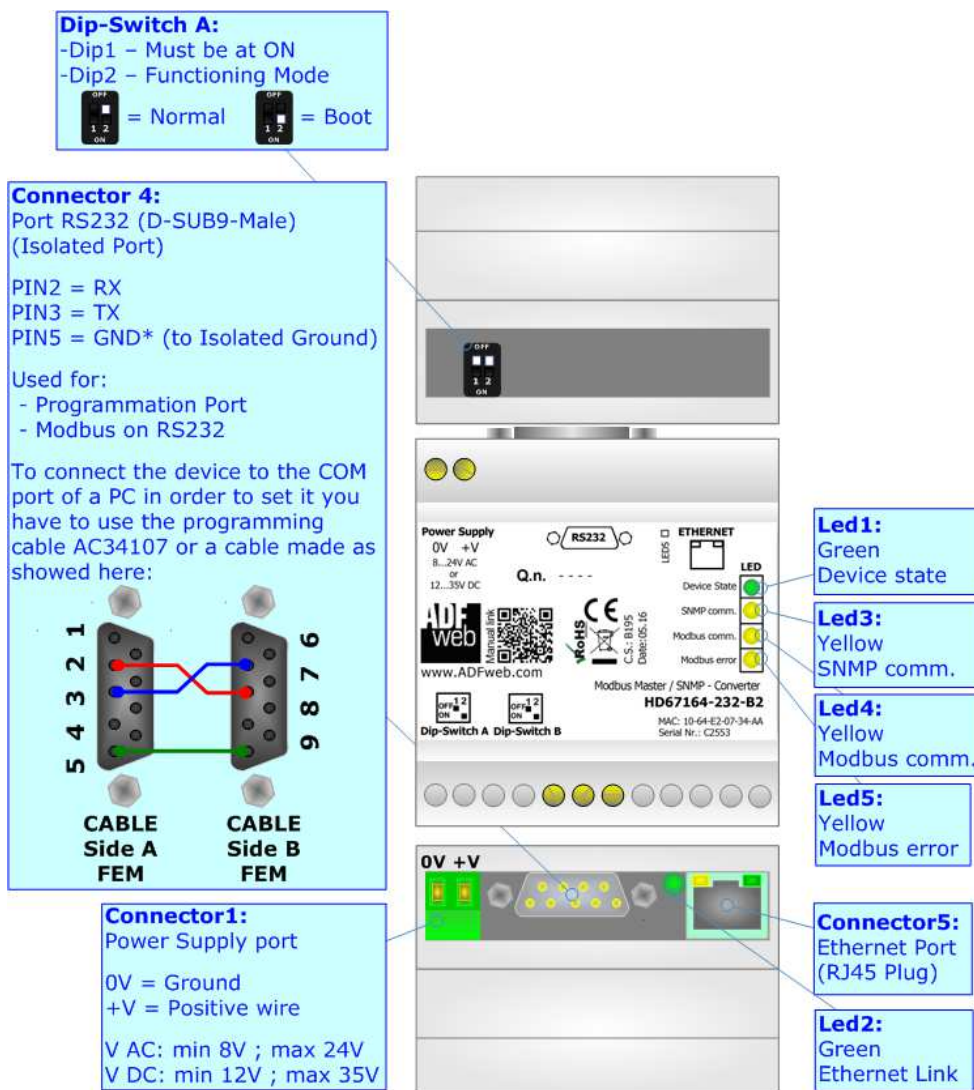

Figure 1f: Connection scheme for HD67164-232-B2

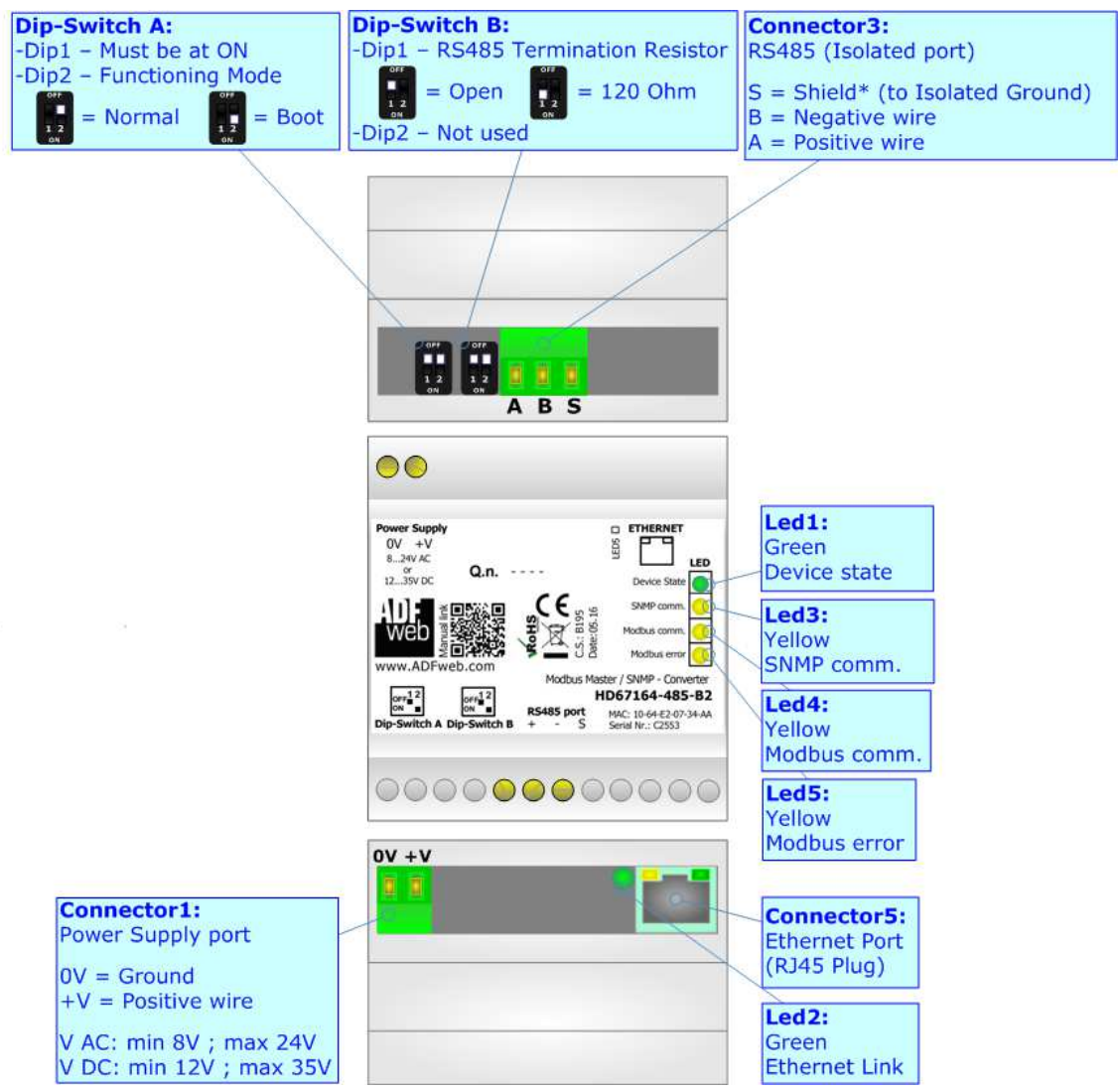

Figure 1g: Connection scheme for HD67164-485-B2

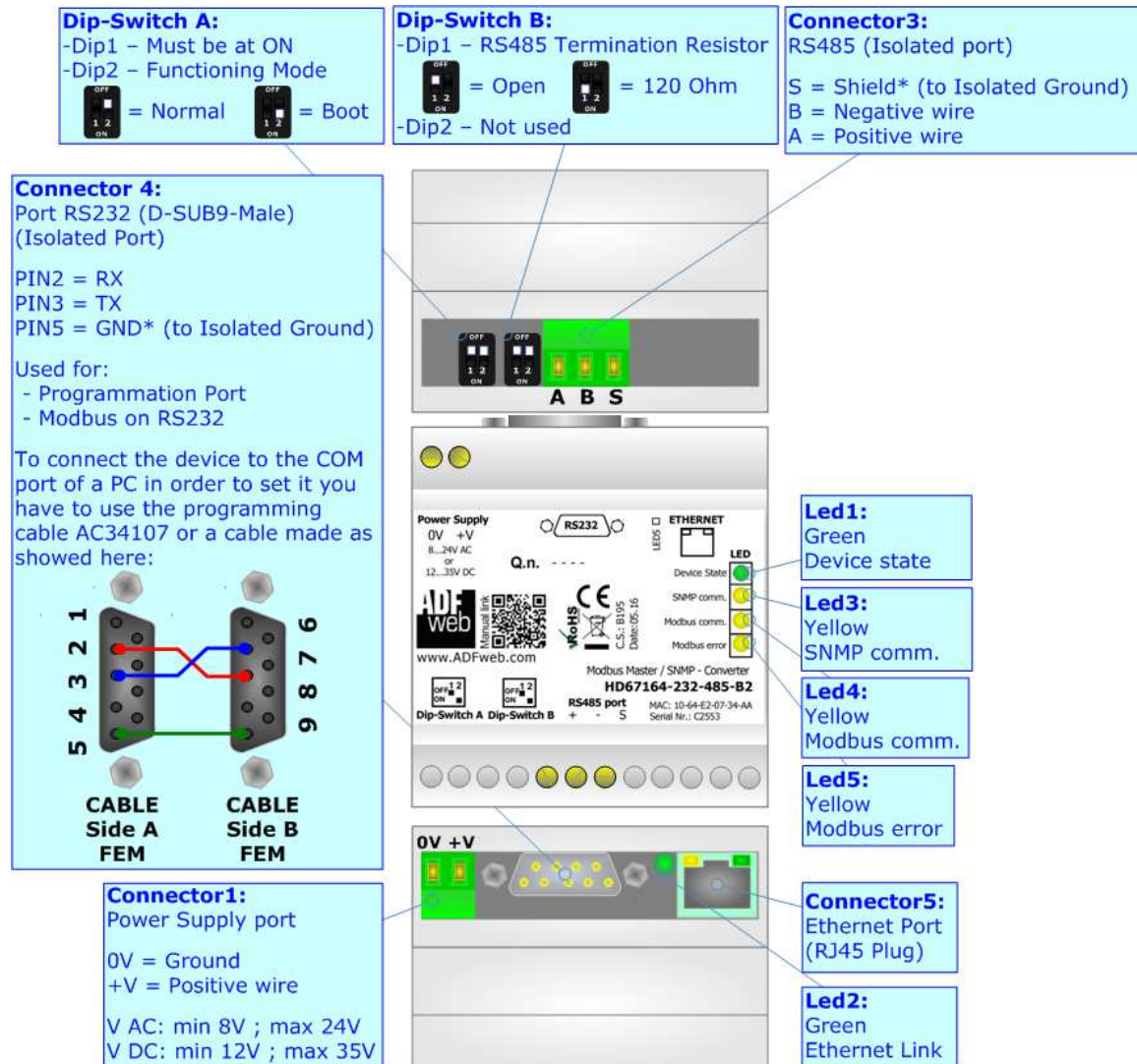

Figure 1h: Connection scheme for HD67164-232-485-B2

CHARACTERISTICS:

The HD67164-A1 and HD67164-B2 is a Modbus Master / SNMP Agent - Converter.

It has the following characteristics:

- Up to 1024 bytes in reading and 1024 bytes in writing;
- Triple isolation between Serial - Power Supply, Serial - Ethernet, Power Supply - Ethernet.
- Two-directional information between Modbus bus and SNMP bus;
- Mountable on 35mm Rail DIN;
- Wide power supply input range: 8...24V AC or 12...35V DC;
- Wide temperature range: -40°C / 85°C [-40°F / +185°F].

CONFIGURATION:

You need Compositor SW67164 software on your PC in order to perform the following:

- Define the parameters of SNMP line;
- Define the parameters of Modbus line;
- Define the Modbus variables to read/write from/to the Modbus slaves;
- Define the SNMP OIDs;
- Create the MIB file;
- Update the device.

POWER SUPPLY:

The devices can be powered at 8...24V AC and 12...35V DC. For more details see the two tables below.

VAC		VDC	
Vmin	Vmax	Vmin	Vmax
8V	24V	12V	35V

Consumption at 24V DC:

Device	Consumption [W/VA]
HD67164-xxx-A1	3.5
HD67164-xxx-B2	3.5

Connector1:
 Power Supply port
 0V = Ground
 +V = Positive wire
 V AC: min 8V ; max 24V
 V DC: min 12V ; max 35V

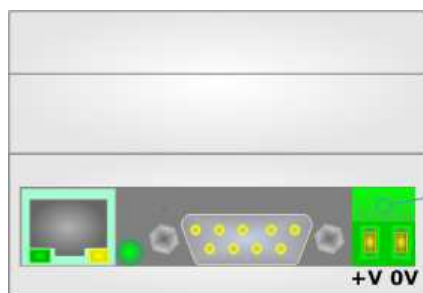
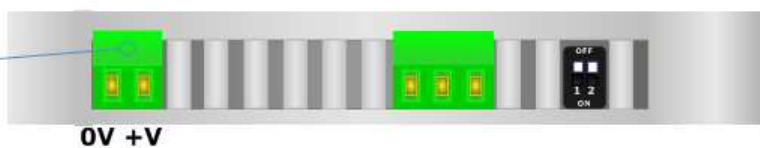

Connector1:
 Power Supply port
 0V = Ground
 +V = Positive wire
 V AC: min 8V ; max 24V
 V DC: min 12V ; max 35V

Caution: Not reverse the polarity power

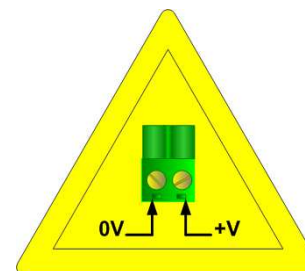

HD67164-xxx-A1

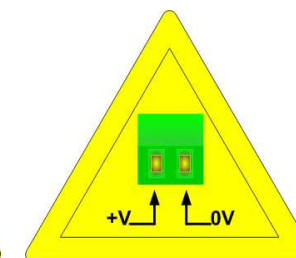

HD67164-xxx-B2

FUNCTION MODES:

The device has got two functions mode depending of the position of the 'Dip2 of Dip-Switch A':

- The first, with 'Dip2 of Dip-Switch A' at "OFF" position, is used for the normal working of the device.
- The second, with 'Dip2 of Dip-Switch A' at "ON" position, is used for upload the Project and/or Firmware.

For the operations to follow for the updating, see 'UPDATE DEVICE' section.

According to the functioning mode, the LEDs will have specifics functions, see 'LEDS' section.

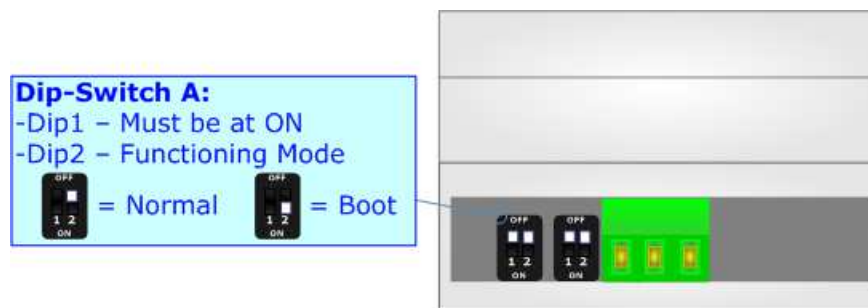

Warning:

Dip1 of 'Dip-Switch A' must be at ON position for working even if the Ethernet cable isn't inserted.

LEDS:

The devices have got four (five for HD67164-B2) LEDs that are used to give information of the functioning status. The various meanings of the LEDs are described in the table below.

LED	Normal Mode	Boot Mode
1: Device state (green)	Blinks slowly (~1Hz)	Blinks quickly: Boot state Blinks very slowly (~0.5Hz): update in progress
2: Ethernet Link (green)	ON: Ethernet cable connected OFF: Ethernet cable disconnected	ON: Ethernet cable connected OFF: Ethernet cable disconnected
3: SNMP communication (green)	Blinks when a SNMP request is received	Blinks quickly: Boot state Blinks very slowly (~0.5Hz): update in progress
4: Modbus communication (green)	Blinks when Modbus frames (RS232/RS485/RS422) are received	Blinks quickly: Boot state Blinks very slowly (~0.5Hz): update in progress
5: Modbus error (yellow) (Present only on HD67164-B2)	ON: at least one configured Modbus request hasn't correct reply OFF: communication is working	Blinks quickly: Boot state Blinks very slowly (~0.5Hz): update in progress

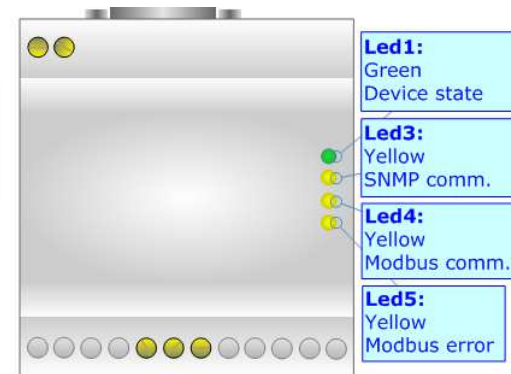

SNMP:

The SNMP connection must be made using Connector5 of HD67164-A1/B2 with at least a Category 5E cable. The maximum length of the cable should not exceed 100m. The cable has to conform to the T568 norms relative to connections in cat.5 up to 100 Mbps. To connect the device to an Hub/Switch is recommended the use of a straight cable, to connect the device to a PC/other is recommended the use of a cross cable.

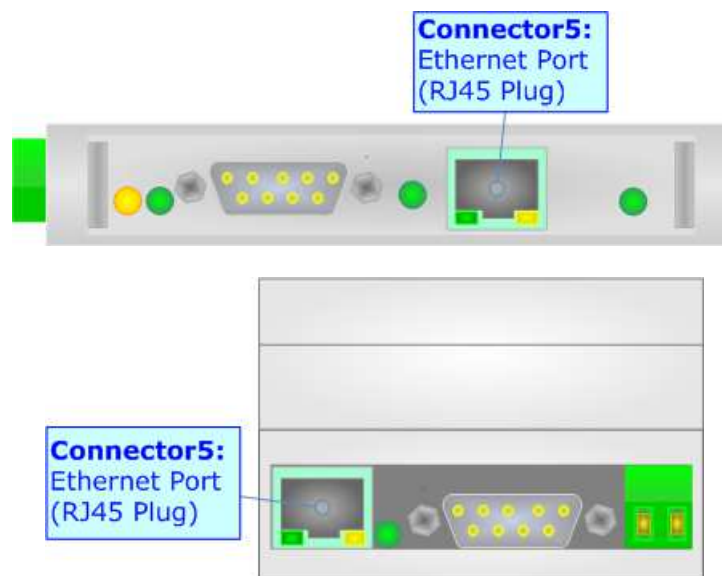
**RS232:**

The connection from RS232 socket to a serial port (example one from a personal computer) must be made with a NULL MODEM cable (a serial cable where the pins 2 and 3 are crossed).

It is recommended that the RS232 cable not exceed 15 meters.

RS485:

For terminate the RS485 line with a 120Ω resistor it is necessary to put ON dip 1, like in figure.

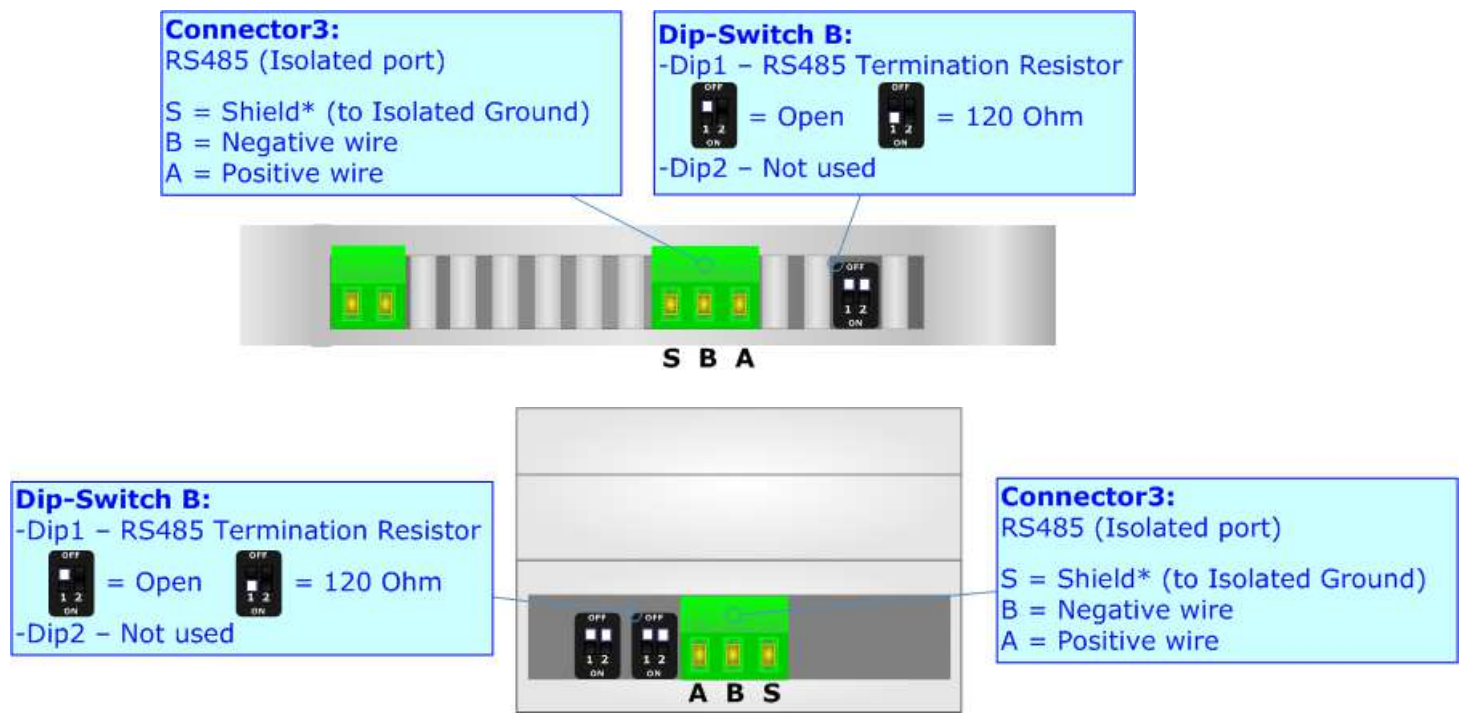

The maximum length of the cable should be 1200m (4000 feet).

Here some codes of cables:

- Belden: p/n 8132 - 2x 28AWG stranded twisted pairs conductor + foil shield + braid shield;
- Belden p/n 82842 - 2x 24AWG stranded twisted pairs conductor + foil shield + braid shield;
- Tasker: p/n C521 - 1x 24AWG twisted pair conductor + foil shield + braid shield;
- Tasker: p/n C522 - 2x 24AWG twisted pairs conductor + foil shield + braid shield.

RS422:

For terminate the RS422 line with a 120Ω resistor it is necessary to put ON dip 1 for T line and/or put ON dip 2 for R line, like in figure.

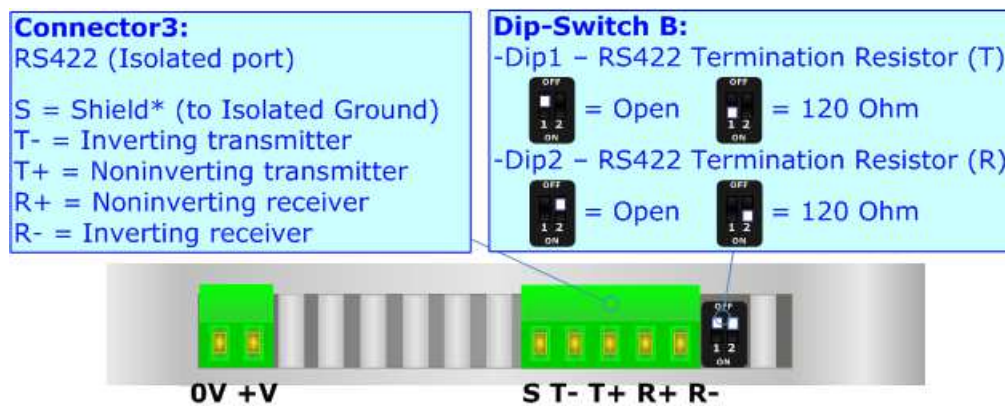

The maximum length of the cable should be 1200m (4000 feet).

USE OF COMPOSITOR SW67164:

To configure the Converter, use the available software that runs with Windows called SW67164. It is downloadable on the site www.adfweb.com and its operation is described in this document. *(This manual is referenced to the last version of the software present on our web site).* The software works with MSWindows (XP, Vista, Seven, 8, 10; 32/64bit).

When launching the SW67164, the window below appears (Fig. 2).



Note:

It is necessary to have installed .Net Framework 4.

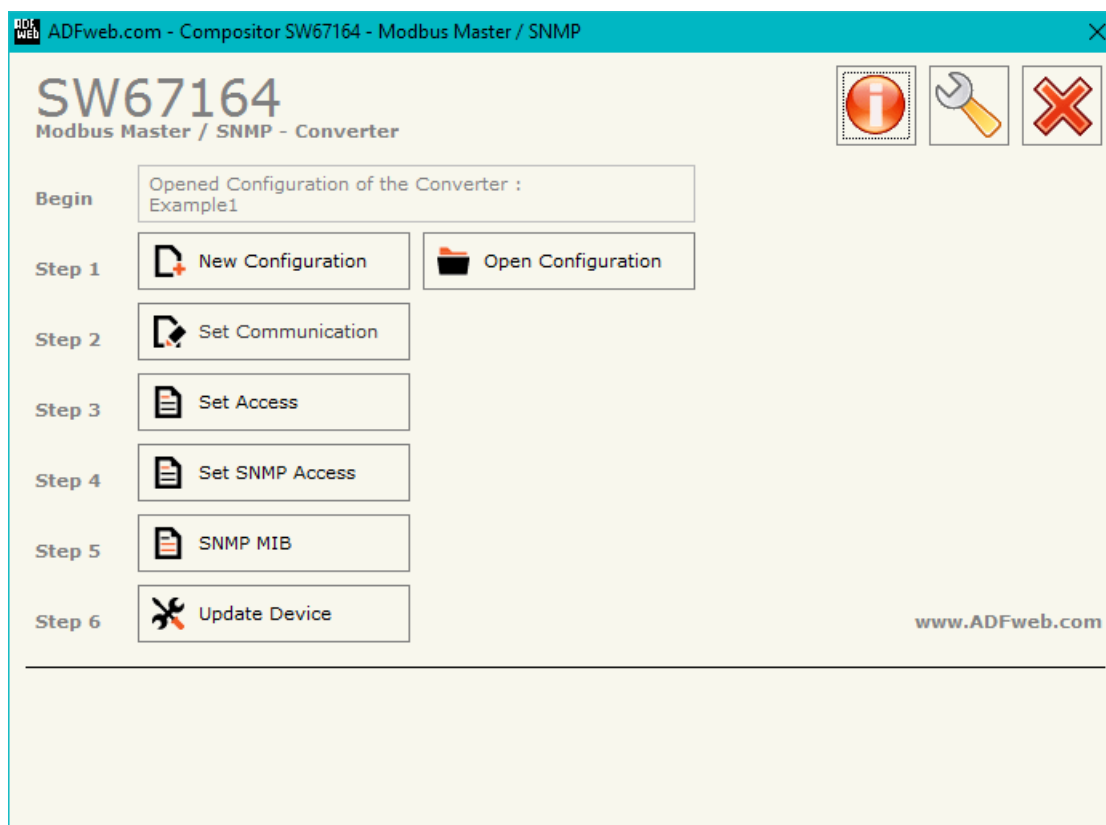
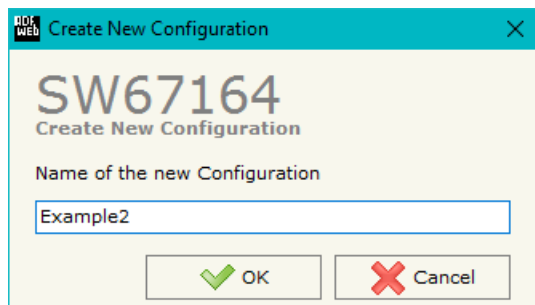

Figure 2: Main window for SW67164

NEW CONFIGURATION / OPEN CONFIGURATION:

The “**New Configuration**” button creates the folder which contains the entire device’s configuration.



A device’s configuration can also be imported or exported:

- To clone the configurations of a Programmable “Modbus Master / SNMP Agent - Converter” in order to configure another device in the same manner, it is necessary to maintain the folder and all its contents;
- To clone a project in order to obtain a different version of the project, it is sufficient to duplicate the project folder with another name and open the new folder with the button “**Open Configuration**”.

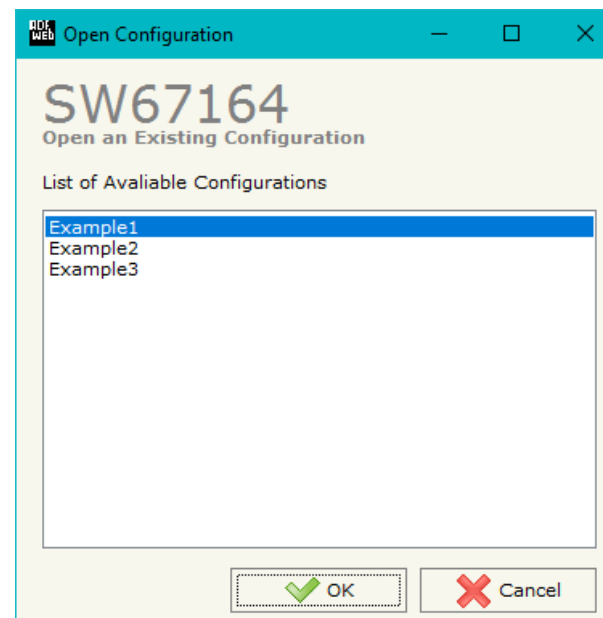

SOFTWARE OPTIONS:

By pressing the “**Settings**” () button there is the possibility to change the language of the software and check the updatings for the compositor.

In the section “Language” it is possible to change the language of the software.

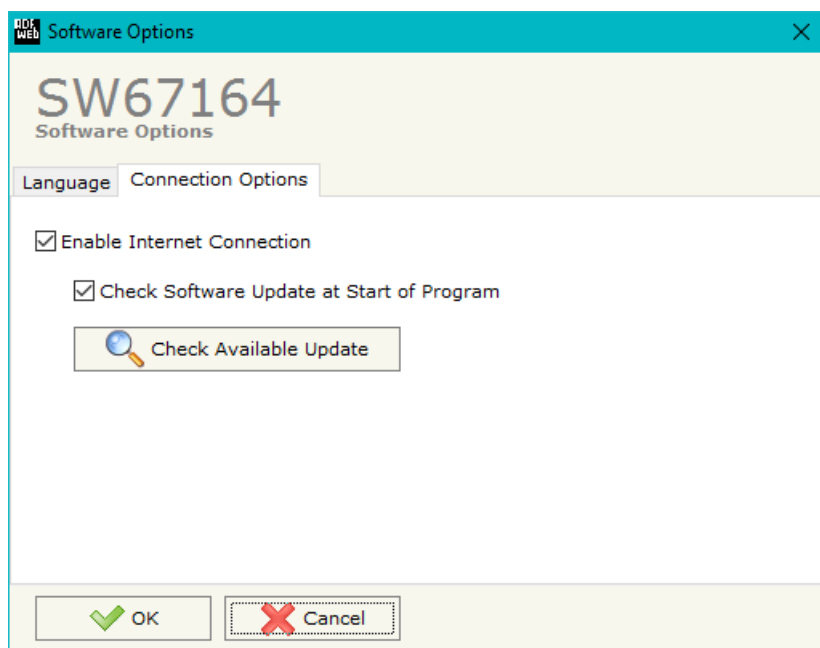

In the section “Connection Options”, it is possible to check if there are some updatings of the software compositor in ADFweb.com website.

Checking the option “**Check Software Update at Start of Program**”, the SW67164 check automatically if there are updatings when it is launched.

SET COMMUNICATION:

This section define the fundamental communication parameters of two buses, SNMP and Modbus.

By Pressing the "**Set Communication**" button from the main window for SW67164 (Fig. 2) the window "Set Communication" appears (Fig. 3).

The window is divided in two sections, one for the SNMP and the other for the Modbus Master.

The means of the fields for "SNMP" are:

- In the field "**IP ADDRESS**" the IP address of the converter is defined;
- In the field "**SUBNET Mask**" the SubNet Mask of the converter is defined;
- In the field "**GATEWAY**" the default gateway of the network is defined. This feature can be
- In the field "**SNMP Name of Station**" the name for SNMP Agent station is defined;
- In the field "**Contact**" the contact for SNMP Agent station is defined;
- In the field "**Location**" the location for SNMP Agent station is defined;
- In the field "**Map Type**" it is possible to select the type of SNMP map to use. It is possible to choose between "Dynamic Map (Recommended)" (see page 30) or "Fixed Map" (see page 35). It is suggested the "Dynamic Map".

The means of the fields for the "Modbus Master" section are:

- In the field "**Serial**" the serial to use is defined (RS232, RS485 or RS422);
- In the field "**Baudrate**" the baudrate for the serial line is defined;
- In the field "**Parity**" the parity of the serial line is defined;
- In the "**TimeOut (ms)**" define the maximum time that the device attends for the answer from the slave interrogated;
- In the field "**Communication Idle Time (ms)**" the minimum delay between two requests is defined.

The screenshot shows a web-based configuration window titled "Set Communication" for device "SW67164". The window is divided into two main sections: "SNMP" and "Modbus Master".

SNMP Section:

- IP ADDRESS:** 192.168.0.10
- SUBNET Mask:** 255.255.255.0
- GATEWAY:** 192.168.0.1
- SNMP Name of Station:** devicename1
- Contact:** ADF
- Location:** ADF
- Map Type:** Dynamic Map (Recommended)

Modbus Master Section:

- Serial:** RS485
- Baudrate:** 115200
- Parity:** NONE
- TimeOut (ms):** 1000
- Communication Idle Time (ms):** 100

At the bottom of the window, there are two buttons: "OK" (with a green checkmark) and "Cancel" (with a red X).

Figure 3: "Set Communication" window

SET ACCESS:

By pressing the **Set Access** button from the main window for SW67164 (Fig. 2) the window "Set Access" appears.

This window is divided in two parts, the "Modbus Read" (Fig. 4a) and the "Modbus Write" (Fig. 4b).

The first part "Modbus Read" is used to read the data from the Modbus slaves, and make them available to read from the Master PROFINET. The second part "Modbus Write" is used to write the data that arrives from the Master PROFINET into the slaves Modbus.

MODBUS READ

The means of the fields are:

- ✦ In the field **Slave ID** the address of the Modbus device to read is defined;
- ✦ In the field **Type** the data type of the register to read is defined. It is possible to choose between the following:
 - Coil Status;
 - Input Status
 - Holding Register;
 - Input Register.

N	Slave ID	Type	Address	NPoint	Poll Time	Max Error	Position	Start Bit	Swap	Swap Word	Mnemonic
1	1	Holding Register	100	1	1000	0	0	0	<input type="checkbox"/>	<input type="checkbox"/>	Temperature
2	2	Holding Register	200	2	2000	0	2	0	<input type="checkbox"/>	<input type="checkbox"/>	RPM
3									<input type="checkbox"/>	<input type="checkbox"/>	
4									<input type="checkbox"/>	<input type="checkbox"/>	
5									<input type="checkbox"/>	<input type="checkbox"/>	

Figure 4a: "Set Access → Modbus Read"

- ✦ In the field **Address** the starting address of the register to be read is defined;
- ✦ In the field **NPoint** the number of consecutive registers to be read is defined;
- ✦ In the field **Poll Time** the delay time to make the request is defined;
- ✦ In the field **Max Error** the number of consecutive errors that the converter waits before suspending the request until the next reboot is defined. If is set to '0' this function is disabled;
- ✦ In the field **Position** the address of the SNMP array where placing the information is defined;
- ✦ In the field **Start Bit** the starting bit of the first byte of the field "Position" is defined. Valid only for the "Coil Status" and "Input Status";
- ✦ If the field **Swap** is checked, the data from the Modbus registers are swapped;
- ✦ If the field **Swap Word** is checked, the words of the data read are swapped between them;
- ✦ In the field **Mnemonic** the description for the request is defined.

MODBUS WRITE

The means of the fields are:

- In the field "**Slave ID**" the address of the Modbus device that you have to write is defined;
- In the field "**Type**" the data type of the register to write is defined. It is possible to choose between the following:
 - Coil Status;
 - Holding Register.
- In the field "**Address**" the start address of the register to be written is defined;
- In the field "**NPoint**" the number of consecutive registers to be written is defined;
- In the field "**Poll Time**" the delay time to make the request is defined;
- If the field "**On Change**" is checked, the converter sends the writing request when the data from SNMP side change value.
- In the field "**Max Error**" the number of consecutive errors that the converter waits before suspending the request until the next reboot is defined. If is set to '0' this function is disabled;
- In the field "**Position**" the address of the SNMP array where taking the information is defined;
- In the field "**Start Bit**" the starting bit of the first byte of the field "Position" is defined. Valid only for the "Coil Status" and "Input Status";
- If the field "**Swap**" is checked, the data written the Modbus registers are swapped;
- If the field "**Swap Word**" is checked, the words of the data written are swapped between them;
- In the field "**Mnemonic**" the description for the request is defined.

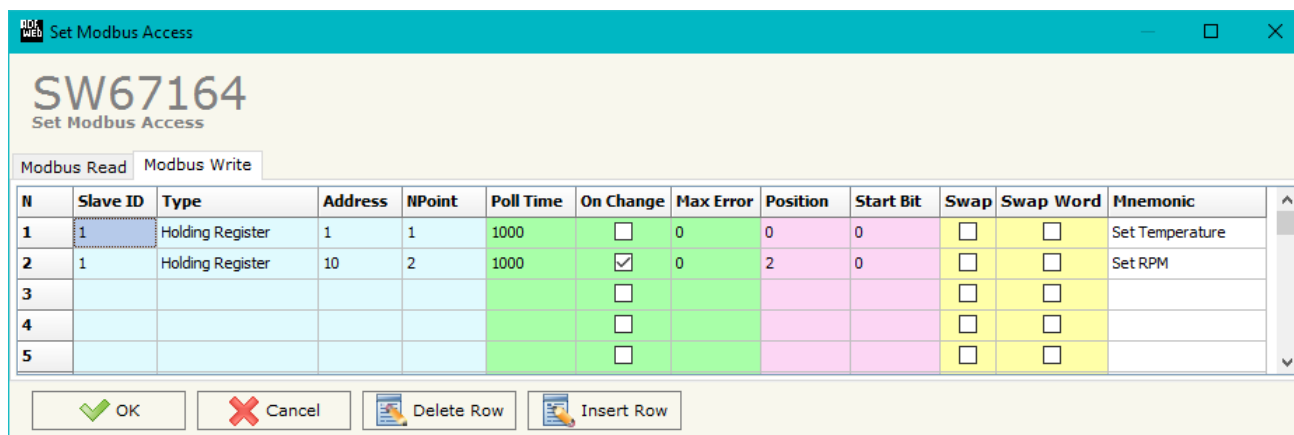

Figure 4b: "Set Access→Modbus Write" window

Note:

If you want that the converter sends the data only "On change", the "Poll Time" must be at 0.

Note:

If the field "On change" is checked and the "Poll Time" is different from 0, the converter sends the writing request cyclically and also when the data is changed.

SET SNMP ACCESS (only if “Dynamic Map” is used):

By pressing the “**Set SNMP Access**” button from the main window for SW67164 (Fig. 2) the “Set SNMP Access” window appears (Fig. 5). In this section, it is possible to create the OIDs for SNMP side to read or write using GET and SET commands or to be sent as TRAP messages. The window is divided into two tables, one for SNMP readings and one for SNMP writings.

The data of the columns in the “SNMP Read” have the following meanings:

- If the field “**Enable**” is checked, the SNMP OID is enabled;
- In the field “**Community Name**” the name of the Community is defined;
- In the field “**Type**” the type of data of the OID is defined (Octet String or Integer);
- If the field “**On Change**” is checked, the OID is sent as Trap when the data from Modbus side change;
- If the field “**On Timer**” is checked, the OID is sent as Trap cyclically;
- In the field “**Time (ms)**” the delay time for the Trap send is defined (if “On Timer” option is checked);
- In the field “**Position**” the starting byte of the internal memory array where taking the data is defined;
- In the field “**Start Bit**” the starting bit of the selected Position is defined;
- In the field “**Num Bits/Bytes**” the dimension of the OID is defined. For ‘Int’ type the dimension is in bit, for ‘String’ type the dimension is in bytes;
- In the field “**Description**” the description/name of the OID is defined;
- In the field “**IP Address**” the IP Address of the SNMP device where addressing the Trap message is defined. This field is used only when ‘On Change’ or ‘On Timer’ option is checked;
- In the field “**Conversion**” it is possible to select the data conversion to apply to the data (Float to Int);
- In the field “**Mnemonic**” a brief description of the OID is defined.

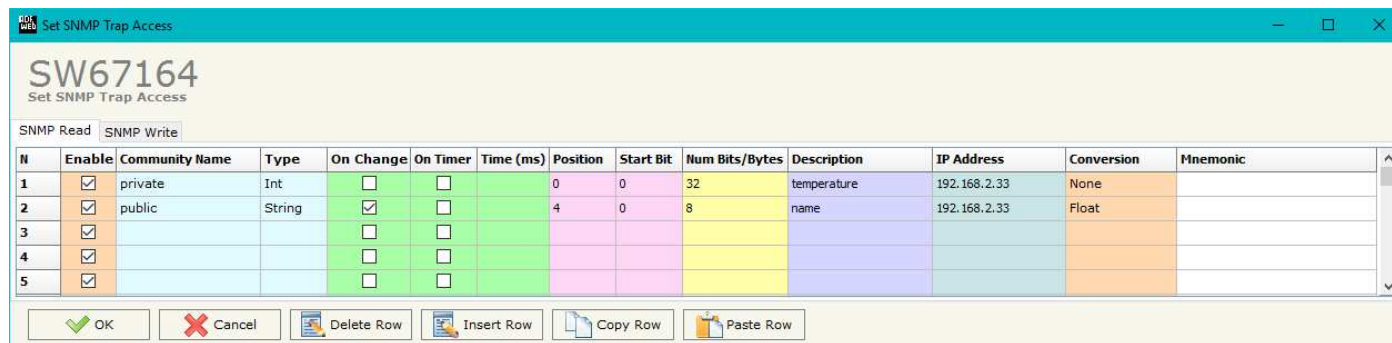

Figure 5a: “Set SNMP Access -> SNMP Read” window

The data of the columns in the “SNMP Write” have the following meanings:

- If the field “**Enable**” is checked, the SNMP OID is enabled;
- In the field “**Community Name**” the name of the Community is defined;
- In the field “**Type**” the type of data of the OID is defined (Octet String or Integer);
- In the field “**Position**” the starting byte of the internal memory array where mapping the data is defined;
- In the field “**Start Bit**” the starting bit of the selected Position is defined;
- In the field “**Num Bits/Bytes**” the dimension of the OID is defined. For ‘Int’ type the dimension is in bit, for ‘String’ type the dimension is in bytes;
- In the field “**Description**” the description/name of the OID is defined;
- In the field “**Mnemonic**” a brief description of the OID is defined.

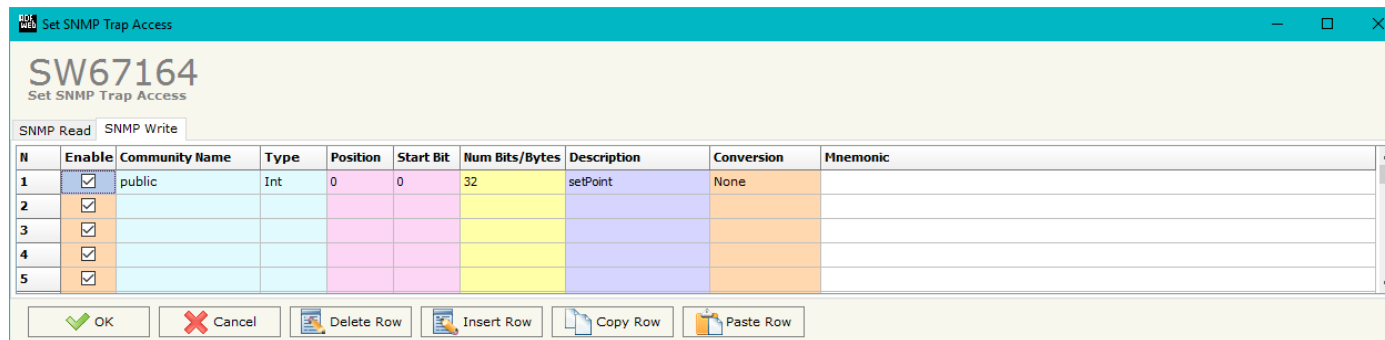

Figure 5b: “Set SNMP Access -> SNMP Write” window



Note:

If the fields “On Change” and “On Timer” are disabled, the OID is readable using standard GET command. If one of these fields is enabled, the OID is sent as Trap and it is readable by GET command too.



Note:

The field “Description” must start with lowercase letter and it cannot contain special chars (just letters and numbers). All the “Description” fields must be different between them.

SNMP MIB (only if “Dynamic Map” is used):

By pressing the “**SNMP MIB**” button it is possible to save the MIB file for the SNMP Manager.

UPDATE DEVICE:

By pressing the **"Update Device"** button, it is possible to load the created Configuration into the device; and also the Firmware, if necessary.

If you don't know the actual IP address of the device you have to use this procedure:

- Turn OFF the Device;
- Put Dip1 of 'Dip-Switch A' in ON position;
- Turn ON the device
- Connect the Ethernet cable;
- Insert the IP **"192.168.2.205"**;
- Press the **"Ping"** button, "Device Found!" must appear;
- Press the **"Next"** button;
- Select which operations you want to do;
- Press the **"Execute update firmware"** button to start the upload;
- When all the operations are "OK" turn OFF the Device;
- Put Dip1 of 'Dip-Switch A' at OFF position;
- Turn ON the device.

If you know the actual IP address of the device, you have to use this procedure:

- Turn ON the Device with the Ethernet cable inserted;
- Insert the actual IP of the Converter;
- Press the **"Ping"** button, must appear "Device Found!";
- Press the **"Next"** button;
- Select which operations you want to do;
- Press the **"Execute update firmware"** button to start the upload;
- When all the operations are "OK" the device automatically goes at Normal Mode.

At this point the configuration/firmware on the device is correctly update.

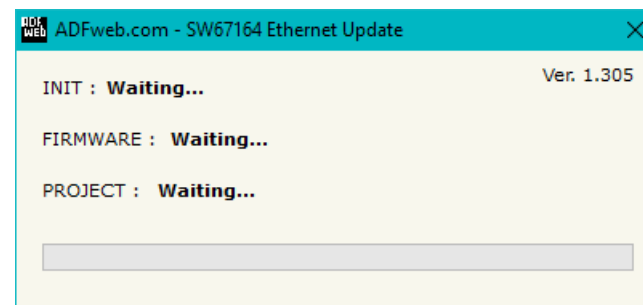
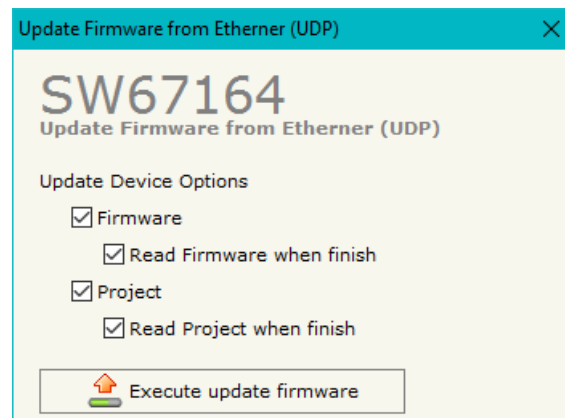
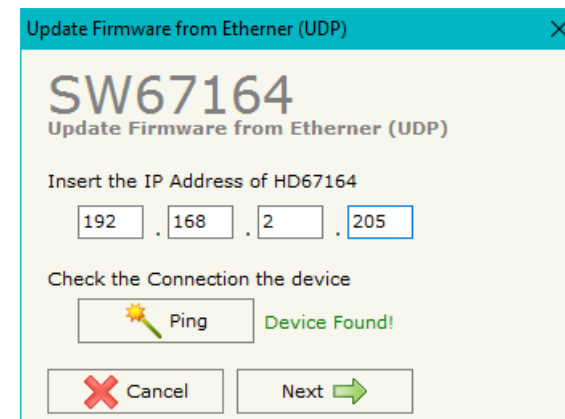





Figure 6: "Update device" windows

 **Note:**
When you install a new version of the software, if it is the first time it is better you do the update of the Firmware in the HD67164-A1/B2 device.

 **Note:**
When you receive the device, for the first time, you also have to update the Firmware in the HD67164-A1/B2 device.

 **Warning:**
If Fig. 7 appears when you try to do the Update try these points before seeking assistance:

- Try to repeat the operations for the updating;
- Try with another PC;
- Try to restart the PC;
- Check the LAN settings;
- If you are using the program inside a Virtual Machine, try to use in the main Operating System;
- If you are using Windows Seven, Vista, 8 or 10 make sure that you have the administrator privileges;
- In case you have to program more than one device, using the "UDP Update", you have to cancel the ARP table every time you connect a new device on Ethernet. For do this you have to launch the "Command Prompt" and write the command "arp -d". Pay attention that with Windows Vista, Seven, 8 or 10 you have to launch the "Command Prompt" with Administrator Rights;
- Pay attention at Firewall lock.

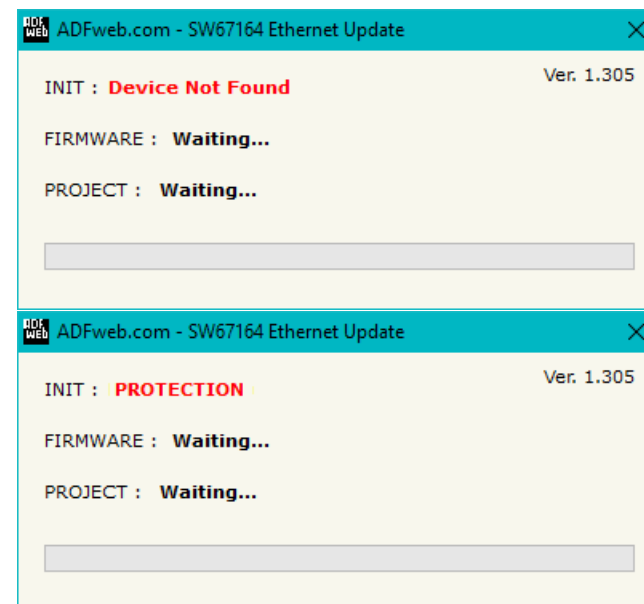

Figure 7: "Protection" window

 In the case of HD67164-A1/B2 you have to use the software "SW67164": www.adfweb.com/download/filefold/SW67164.zip.

SNMP COMMUNICATION (Dynamic Map)

In order to read/write the data from/to Modbus side, it is necessary to use specific SNMP commands in order to see the SNMP Input and write the SNMP Output.

Reading BACnet data from SNMP:

In order to read the data from the HD67164, it is necessary to use the GET command.
Each OID defined in the section "Set SNMP Access -> SNMP Read" will be placed in the MIB tree of the converter.

In addition, it will be possible to read the entire internal map of the converter in memory blocks of 128 bytes: this feature is helpful in phase of configuration of the converter.

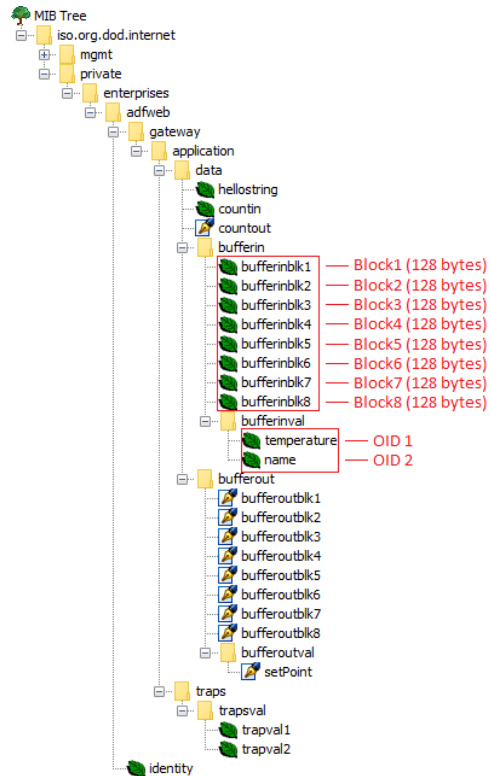

Each SNMP variable created will have its own OID and it will be created following this rule:

- OID 1 (first row of "Set SNMP Access -> SNMP Read" table): **.1.3.6.1.4.1.49314.1.1.1.4.9.1**
- OID 2 (second row of "Set SNMP Access -> SNMP Read" table): **.1.3.6.1.4.1.49314.1.1.1.4.9.2**
- OID X (Xth row of "Set SNMP Access -> SNMP Read" table): **.1.3.6.1.4.1.49314.1.1.1.4.9.X**

The memory blocks are accessible with these OIDs:

- Block1: **.1.3.6.1.4.1.49314.1.1.1.4.1.0**
- Block2: **.1.3.6.1.4.1.49314.1.1.1.4.2.0**
- Block3: **.1.3.6.1.4.1.49314.1.1.1.4.3.0**
- Block4: **.1.3.6.1.4.1.49314.1.1.1.4.4.0**
- Block5: **.1.3.6.1.4.1.49314.1.1.1.4.5.0**
- Block6: **.1.3.6.1.4.1.49314.1.1.1.4.6.0**
- Block7: **.1.3.6.1.4.1.49314.1.1.1.4.7.0**
- Block8: **.1.3.6.1.4.1.49314.1.1.1.4.8.0**

Writing BACnet data from SNMP:

In order to write the data from the HD67164, it is necessary to use the SET command.

Each OID defined in the section "Set SNMP Access -> SNMP Write" will be placed in the MIB tree of the converter.

In addition, it will be possible to write the entire internal map of the converter in memory blocks of 128 bytes: this feature is helpful in phase of configuration of the converter.

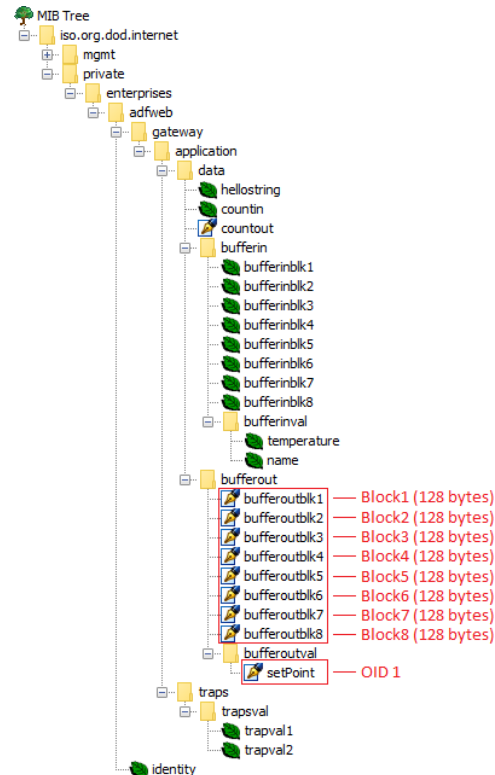

Each SNMP variable created will have its own OID and it will be created following this rule:

- ➔ OID 1 (first row of "Set SNMP Access -> SNMP Write" table): **.1.3.6.1.4.1.49314.1.1.1.5.9.1**
- ➔ OID 2 (second row of "Set SNMP Access -> SNMP Write" table): **.1.3.6.1.4.1.49314.1.1.1.5.9.2**
- ➔ OID X (Xth row of "Set SNMP Access -> SNMP Write" table): **.1.3.6.1.4.1.49314.1.1.1.5.9.X**

The memory blocks are accessible with these OIDs:

- ➔ Block1: **.1.3.6.1.4.1.49314.1.1.1.5.1.0**
- ➔ Block2: **.1.3.6.1.4.1.49314.1.1.1.5.2.0**
- ➔ Block3: **.1.3.6.1.4.1.49314.1.1.1.5.3.0**
- ➔ Block4: **.1.3.6.1.4.1.49314.1.1.1.5.4.0**
- ➔ Block5: **.1.3.6.1.4.1.49314.1.1.1.5.5.0**
- ➔ Block6: **.1.3.6.1.4.1.49314.1.1.1.5.6.0**
- ➔ Block7: **.1.3.6.1.4.1.49314.1.1.1.5.7.0**
- ➔ Block8: **.1.3.6.1.4.1.49314.1.1.1.5.8.0**



Note:

The OIDs in writing are readable too with GET command.

TRAP messages from SNMP:

All the OIDs defined in the "Set SNMP Access -> SNMP Read" table can be sent as TRAP messages too.

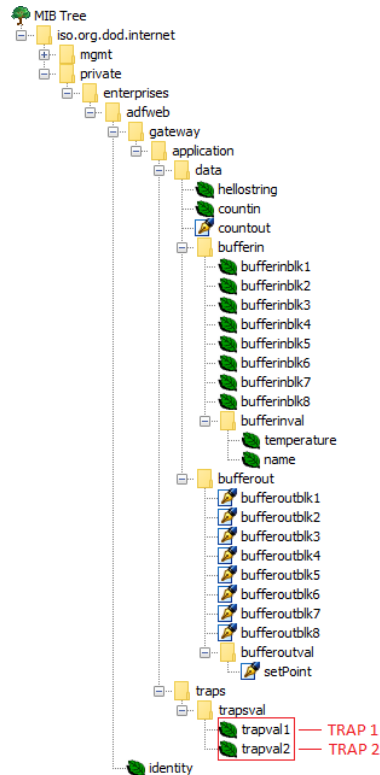

The TRAP messages are contained in the MIB tree and they have these OIDs:

- TRAP 1 (first row of "Set SNMP Access -> SNMP Read" table): .1.3.6.1.4.1.49314.1.1.2.1.1
- TRAP 2 (second row of "Set SNMP Access -> SNMP Read" table): .1.3.6.1.4.1.49314.1.1.2.1.2
- TRAP X (Xth row of "Set SNMP Access -> SNMP Read" table): .1.3.6.1.4.1.49314.1.1.2.1.X

SNMP COMMUNICATION (Fixed Map)

In order to read/write the data from/to Modbus side, it is necessary to use specific SNMP commands in order to see the SNMP Input and write the SNMP Output.

Reading Modbus data from SNMP:

In order to read the data from the HD67164-A1/B2 it is necessary to use the "snmpget" command. The Input array is contained to this internal directory: 1.3.6.1.4.1.33118.1.1.1.4.x.0, where 'x' is the number of data block. Each data block has a dimension of 128 bytes.

Example: you want to read informations of the data block 3. The structure of the command to send is:

snmpget -v1 -cprivate "IP Address of the converter" 1.3.6.1.4.1.33118.1.1.1.4.**3**.0



Figure 8a: MIB Tree Input

Writing Modbus data from SNMP:

In order to write the data to the HD67164-A1/B2 it is necessary to use the "snmpset" command. The Output array is contained to this internal directory: 1.3.6.1.4.1.33118.1.1.1.5.x.0, where 'x' is the number of data block. Each data block has a dimension of 128 bytes.

Example: you want to write informations of the data block 3 with the data '0123456789' (ASCII). The structure of the command to send is:

snmpset -v1 -cprivate "IP Address of the converter" 1.3.6.1.4.1.33118.1.1.1.5.3.0 s "0123456789"

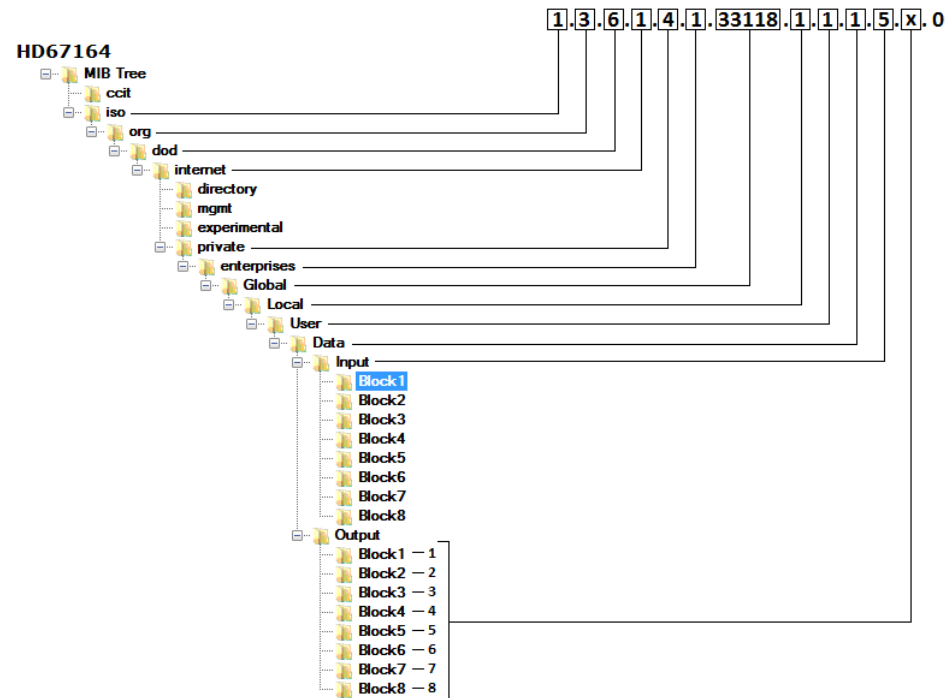

Figure 8b: MIB Tree Output

**Note:**

The data blocks from 1 to 8 are used to read/write the entire internal SNMP arrays of the converter. The data are represented in bytes.

Each Modbus request defined in the section "Set Modbus Access" is associated to a specific OID too. In order to read/write a specific Modbus request from SNMP, it is necessary to use the Data Block 9.



The Modbus request in write will be mapped consecutively to the Modbus request in read. So, in the MIB structure, you will find all the Modbus request in read defined and then all the Modbus request in write. See the following example for more informations.

Example:

We have defined two Modbus reading requests in the section "Set Modbus Access -> Modbus Read" and two Modbus writing requests in the section "Set Modbus Access -> Modbus Write".

In order to read the data related to the first Modbus reading request (the first row of the "Modbus Read" table), the OID to require will be 1.3.6.1.4.1.33118.1.1.1.4.**9.1** where:

-**9**: Data Block 9

-**1**: First row of the "Set Modbus Access" section

The Modbus request in write will be mapped consecutively to the Modbus request in read, so, in this example, in order to write the first Modbus writing request (the first row of the "Modbus Write" table), the OID to require will be 1.3.6.1.4.1.33118.1.1.1.5.**9.3** where:

-**9**: Data Block 9

-**3**: n + 1, where 'n' is the last row's number of the "Modbus Read" table.

**Note:**

It is possible to read an entire data block or only a specific byte/value (for the Data Block 1 to 8). It depends on the OID used:

- 1.3.6.1.4.1.33118.1.1.1.4.x.0: entire data block
- 1.3.6.1.4.1.33118.1.1.1.4.x.y: value of the data block/specific byte

MECHANICAL DIMENSIONS:

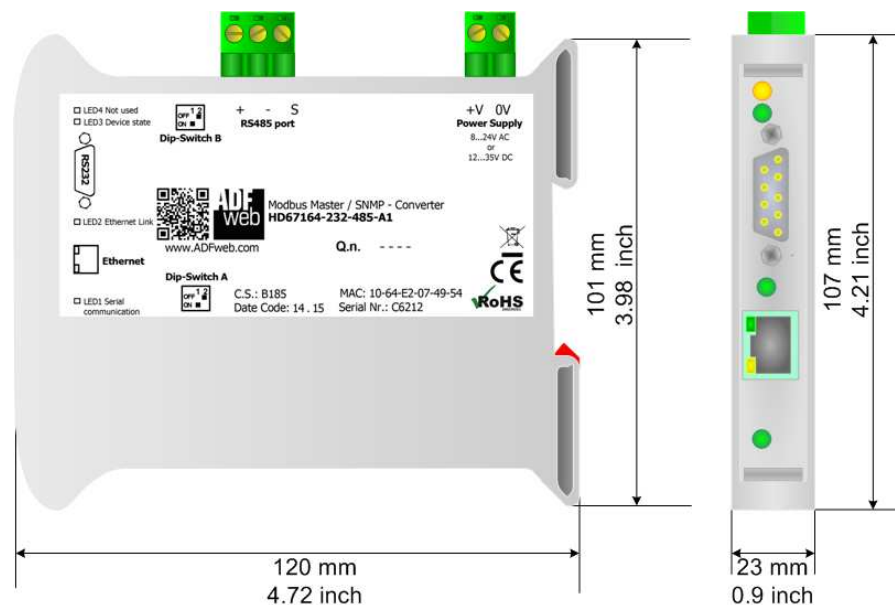

Housing: PVC
Weight: 200g (Approx)

Figure 9a: Mechanical dimensions scheme for HD67164-xxx-A1

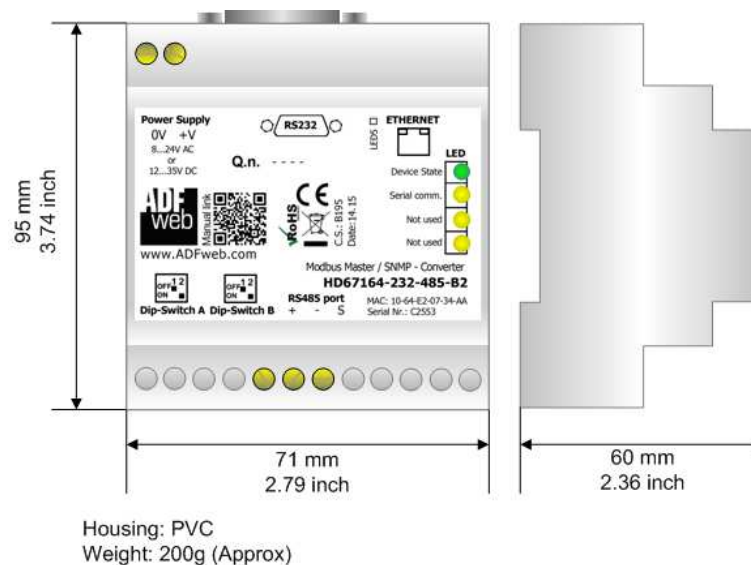

Housing: PVC
Weight: 200g (Approx)

Figure 9b: Mechanical dimensions scheme for HD67164-xxx-B2

ORDERING INFORMATIONS:

The ordering part number is formed by a valid combination of the following:

HD67164 - xxx - x x

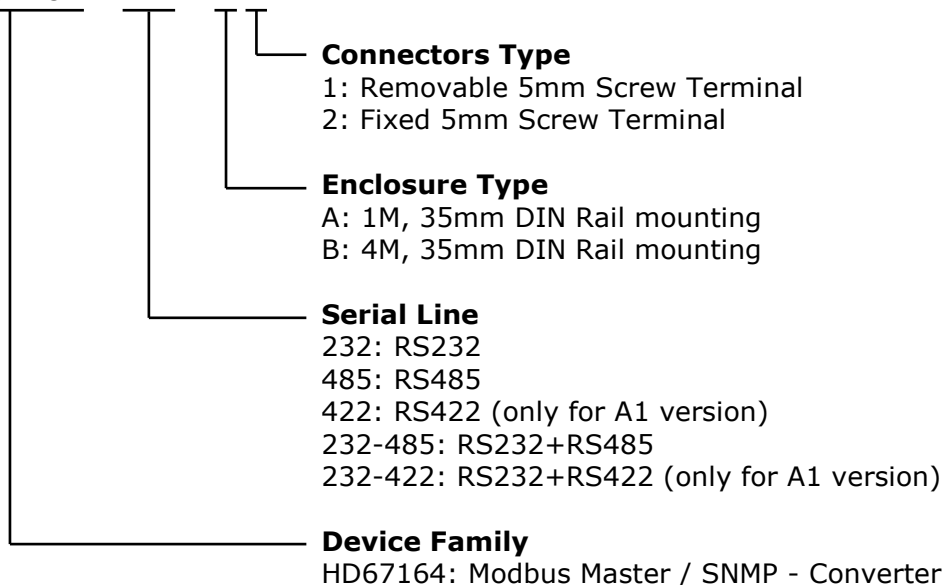

Order Code: HD67164-232-A1	-	Converter Modbus Master / SNMP Converter (RS232 serial)
Order Code: HD67164-485-A1	-	Converter Modbus Master / SNMP Converter (RS485 serial)
Order Code: HD67164-422-A1	-	Converter Modbus Master / SNMP Converter (RS422 serial)
Order Code: HD67164-232-485-A1	-	Converter Modbus Master / SNMP Converter (RS232 + RS485 serial)
Order Code: HD67164-232-422-A1	-	Converter Modbus Master / SNMP Converter (RS232 + RS422 serial)
Order Code: HD67164-232-B2	-	Converter Modbus Master / SNMP Converter (RS232 serial)
Order Code: HD67164-485-B2	-	Converter Modbus Master / SNMP Converter (RS485 serial)
Order Code: HD67164-232-485-B2	-	Converter Modbus Master / SNMP Converter (RS232 + RS485 serial)

ACCESSORIES:

- Order Code: **AC34001** - 35mm Rail DIN - Power Supply 220/240V AC 50/60Hz – 12 V AC
- Order Code: **AC34002** - 35mm Rail DIN - Power Supply 110V AC 50/60Hz – 12 V AC

DISCLAIMER:

All technical content within this document can be modified without notice. The content of the document is a under continual renewal. For losses due to fire, earthquake, third party access or other accidents, or intentional or accidental abuse, misuse, or use under abnormal conditions repairs are charged to the user. ADFweb.com S.r.l. will not be liable for accidental loss of use or inability to use this product, such as loss of business income. ADFweb.com S.r.l. shall not be liable for consequences of improper use.

OTHER REGULATIONS AND STANDARDS:**WEEE INFORMATION**

Disposal of old electrical and electronic equipment (as in the European Union and other European countries with separate collection systems).

— This symbol on the product or on its packaging indicates that this product may not be treated as household rubbish. Instead, it should be taken to an applicable collection point for the recycling of electrical and electronic equipment. If the product is disposed correctly, you will help prevent potential negative environmental factors and impact of human health, which could otherwise be caused by inappropriate disposal. The recycling of materials will help to conserve natural resources. For more information about recycling this product, please contact your local city office, your household waste disposal service or the shop where you purchased the product.

RESTRICTION OF HAZARDOUS SUBSTANCES DIRECTIVE

The device respects the 2002/95/EC Directive on the restriction of the use of certain hazardous substances in electrical and electronic equipment (commonly referred to as Restriction of Hazardous Substances Directive or RoHS).

CE MARKING

The product conforms with the essential requirements of the applicable EC directives.

WARRANTIES AND TECHNICAL SUPPORT:

For fast and easy technical support for your ADFweb.com SRL products, consult our internet support at www.adfweb.com. Otherwise contact us at the address support@adfweb.com

RETURN POLICY:

If while using your product you have any problem and you wish to exchange or repair it, please do the following:

- Obtain a Product Return Number (PRN) from our internet support at www.adfweb.com. Together with the request, you need to provide detailed information about the problem.
- Send the product to the address provided with the PRN, having prepaid the shipping costs (shipment costs billed to us will not be accepted).

If the product is within the warranty of twelve months, it will be repaired or exchanged and returned within three weeks. If the product is no longer under warranty, you will receive a repair estimate.



ADFweb.com S.r.l.
Via Strada Nuova, 17
IT-31010 Mareno di Piave
TREVISO (Italy)
Phone +39.0438.30.91.31
Fax +39.0438.49.20.99
www.adfweb.com

