

\* Please understand key indicators & functions at the first operation.

### 1.1 FRONT PANEL

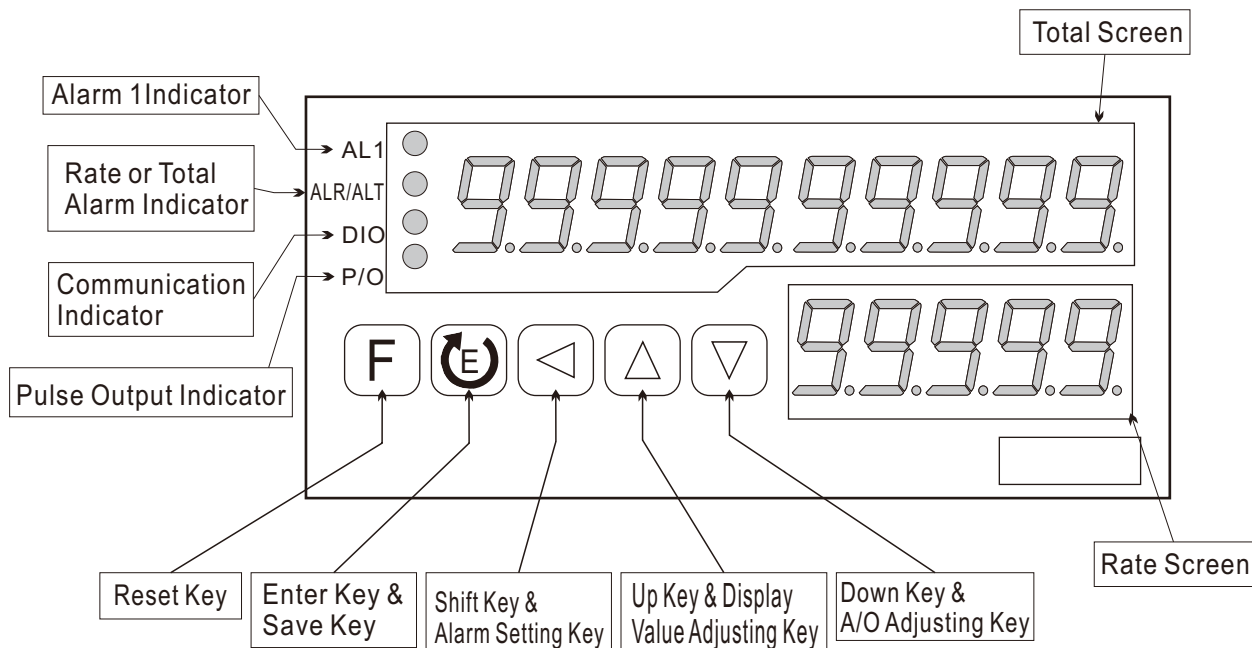

### 1.2 KEY FUNCTIONS

Symbol	Key Name	Descriptions
	Reset Key	1. In the measuring status, press this key can enable the setting function. (AZ or MrSt or HD)
	Enter Key & Save Key	1. In the measuring status, press this key can enter to parameter groups. 2. In the parameter setting, press this key can save the value & go to the next parameter.
	Shift Key & Alarm Setting Key	1. In the measuring status, press this key for 3 sec can enter to Alarm Setpoint Modification. 2. In the parameter page, press this key can enter to parameter setting. 3. In the parameter setting, press this key can move the cursor left.
	Up Key & Display Group Setting Key	1. In the measuring status, press this key for 3 sec can enter to Display Group Setting. 2. In the parameter page, press this key can back to the last parameter page. 3. In the parameter setting, press this key can increase the digit.
	Down Key & A/O Group Setting Key	1. In the measuring status, press this key for 3 sec can enter to A/O Group Setting. 2. In the parameter page, press this key can go to the next parameter page. 3. In the parameter setting, press this key can decrease the digit.
	Compound Key	1. In any status, press this key can back to measuring status.

### 1.3 DIMENSIONS

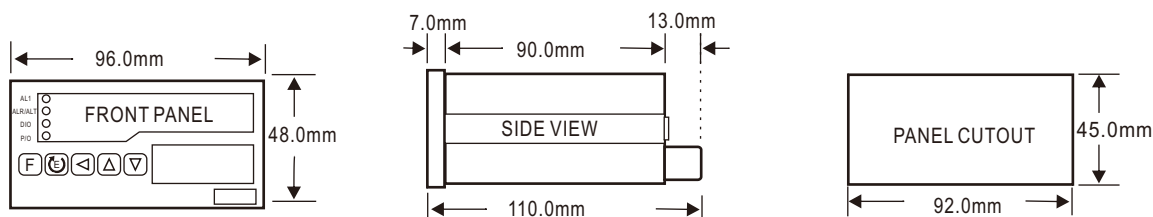

# WIRING CONNECTION

## 2 Alarms for Rate

- Voltage, Current (DC)

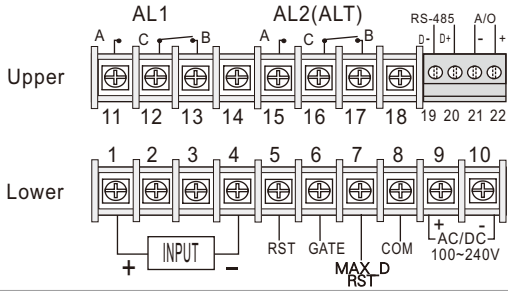

## 2 Alarms for Rate / 1 Alarm for Total / Pulse Output for Total

- Voltage, Current (DC)

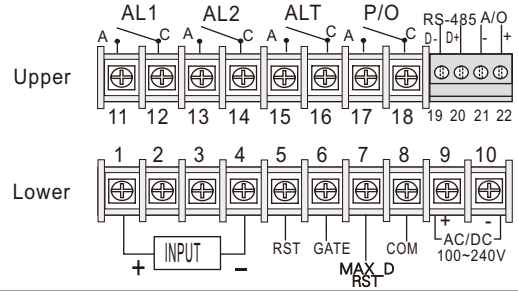

- 4 Wire Sensor

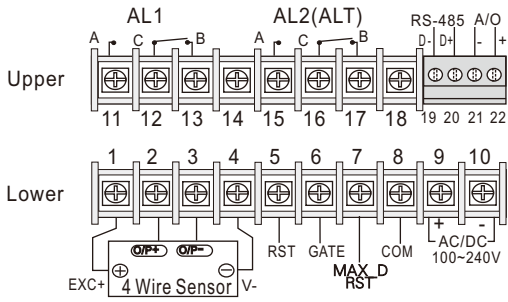

- 4 Wire Sensor

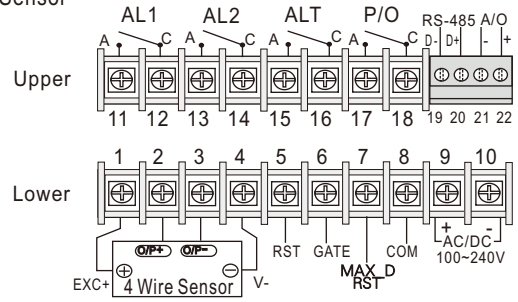

- 2,3 Wire Sensor

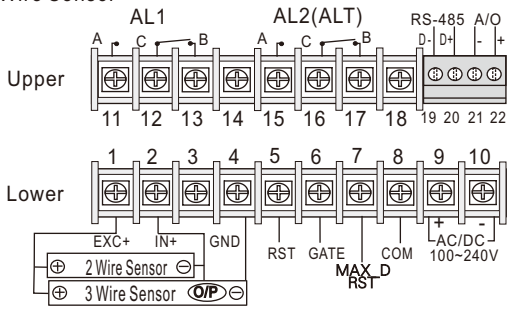

- 2,3 Wire Sensor

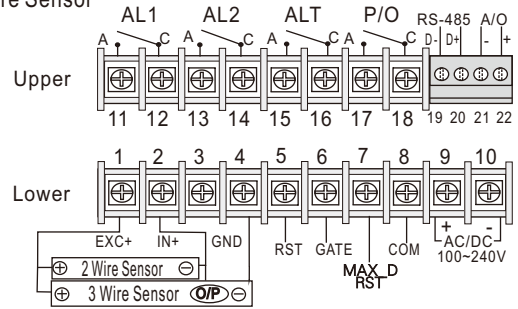



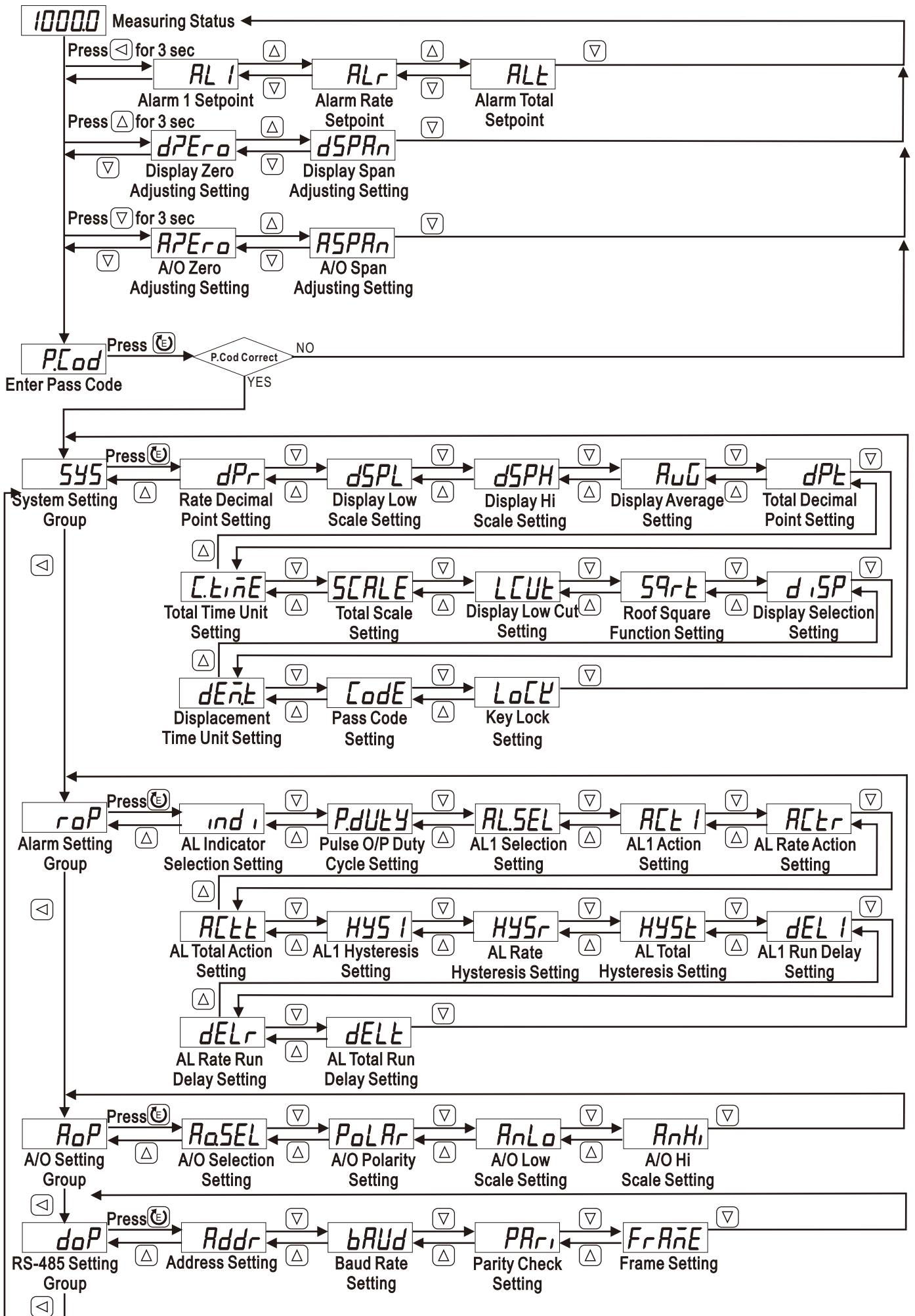



# 2.1 OPERATING SEQUENCE

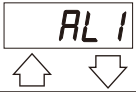











## 2.2 ALARM SETPOINT MODIFICATION

\* In the measuring status, press  for 3 sec can enter to Alarm Setpoint Modification.

Display	Default	Name	Descriptions
	00000	Alarm 1 Setpoint (AL1)	1. Press  to enter the parameter setting, the digit will be flashed. 2. Press  or  can modify Alarm Setpoint. Range: -19999~99999 3. Press <b>ENT</b> to save the value and go to the next parameter.
	00000	Alarm Rate Setpoint (AL2)	
	00000	Alarm Total Setpoint (AL3)	











## 2.3 DISPLAY ZERO & SPAN ADJUSTMENT

\* In the measuring status, press  for 3 sec can enter to Display Zero & Span Adjustment.

Display	Default	Name	Descriptions
	00000	Display Zero Adjusting Setting (dZEro)	1. Press  to enter the parameter setting, the digit will be flashed. 2. Press  to move the flashing LED left to decide the adjusting speed. 3. Press  or  can adjust Display Zero. 4. Press <b>ENT</b> to save the value and go to the next parameter. <b>P.S.: If the flashing LED is on the left side, the adjusting speed will be fast.</b>
	00000	Display Span Adjusting Setting (dSPAN)	1. Press  to enter the parameter setting, the digit will be flashed. 2. Press  to move the flashing LED left to decide the adjusting speed. 3. Press  or  can adjust Display Span. 4. Press <b>ENT</b> to save the value and go to the next parameter. <b>P.S.: If the flashing LED is on the left side, the adjusting speed will be fast.</b>

## 2.4 A/O ZERO & SPAN ADJUSTMENT

\* In the measuring status, press  for 3 sec can enter to A/O Zero & Span Adjustment.

Display	Default	Name	Descriptions
	00000	A/O Zero Adjusting Setting (AZEro)	1. Press  to enter the parameter setting, the digit will be flashed. 2. Press  to move the flashing LED left to decide the adjusting speed. 3. Press  or  can adjust A/O Zero. 4. Press <b>ENT</b> to save the value and go to the next parameter. <b>P.S.: If the flashing LED is on the left side, the adjusting speed will be fast.</b>
	00000	A/O Span Adjusting Setting (ASPA)	1. Press  to enter the parameter setting, the digit will be flashed. 2. Press  to move the flashing LED left to decide the adjusting speed. 3. Press  or  can adjust A/O Span. 4. Press <b>ENT</b> to save the value and go to the next parameter. <b>P.S.: If the flashing LED is on the left side, the adjusting speed will be fast.</b>

## 2.5 ERROR CODE OF SELF-DIAGNOSIS

Display	Descriptions
$10FL$	Input signal is over 120% of input range.
$-10FL$	Input signal is under -10% of input range.
$RdEr$	Input signal is over 180% of input range or meter error.
$doFL$	Input signal is over display range (999999).
$-doFL$	Input signal is under display range (-199999).
$E-00$	EEPROM reading / writing suffers the interference ( about 1 million times).





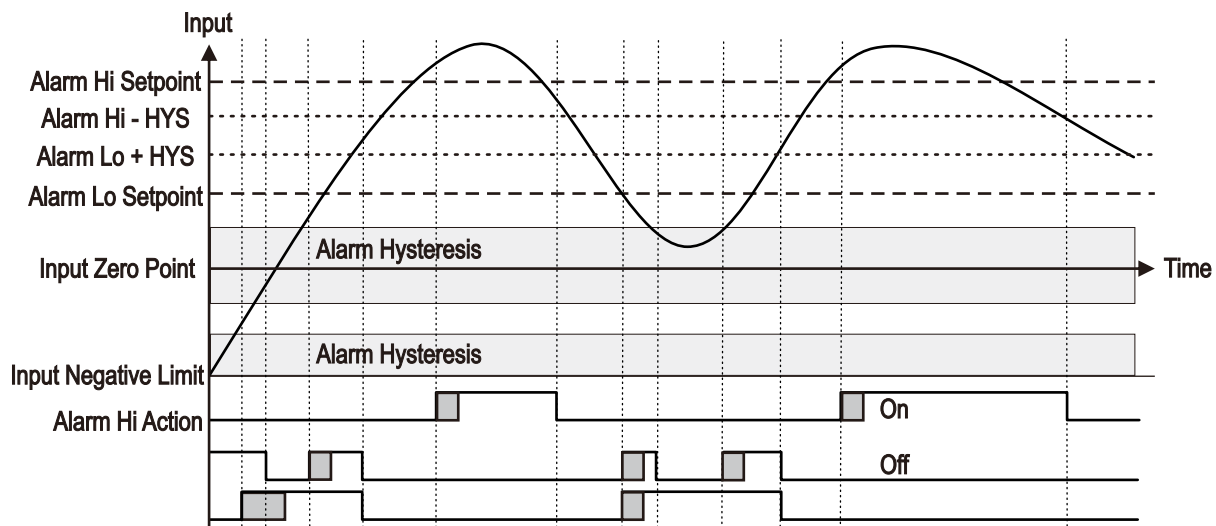





















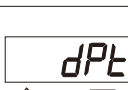



















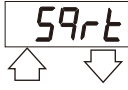





\*\* Please check the wiring connection is correct first, if the problem still exist, please return the meter to the factory.

## 2.6 ALARM OUTPUT ACTION SEQUENCE



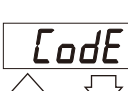









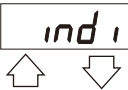

















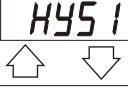

# 3.1 SYSTEM (SYS) SETTING GROUP PROCEDURE

\* While Pass Code is correct, Press  can select System Setting Group.

Display	Default	Name	Descriptions
	00000	Rate Decimal Point Setting (dPr)	1. Press  to enter the parameter setting, the digit will be flashed. 2. Press  or  can select Rate Decimal Point. Range: 0, 1, 2, 3, 4 (DPR) 3. Press <b>ENT</b> to save the value and go to the next parameter.
	00000	Display Low Scale Setting (DSPL)	1. Press  to enter the parameter setting, the digit will be flashed. 2. Press  or  can modify Display Low Scale. Range: 0~99999 3. Press <b>ENT</b> to save the value and go to the next parameter.
	99999	Display Hi Scale Setting (DSPH)	1. Press  to enter the parameter setting, the digit will be flashed. 2. Press  or  can modify Display Hi Scale. Range: 0~99999 3. Press <b>ENT</b> to save the value and go to the next parameter.
	00005	Display Average Setting (AvG)	1. Press  to enter the parameter setting, the digit will be flashed. 2. Press  or  can modify Display Average. Range: 1~99 If this value is large, display will be stable & smooth. 3. Press <b>ENT</b> to save the value and go to the next parameter.
	00000	Total Decimal Point Setting (dPt)	1. Press  to enter the parameter setting, the digit will be flashed. 2. Press  or  can select Total Decimal Point. Range: 0, 1, 2, 3, 4, 5, 6, 7, 8, 9 (DPT) 3. Press <b>ENT</b> to save the value and go to the next parameter.
	SEC	Total Time Unit Setting (C.tiME)	1. Press  to enter the parameter setting, the digit will be flashed. 2. Press  or  can select Total Time Unit. Range: SEC (Second), Min (Minute), hour (Hour), dAY (Day), MonthH (Month) 3. Press <b>ENT</b> to save the value and go to the next parameter.
	10000	Total Scale Setting (SCALE)	1. Press  to enter the parameter setting, the digit will be flashed. 2. Press  or  can modify Input Scale. Range: 0.0001~9.9999 3. Press <b>ENT</b> to save the value and go to the next parameter.
	00000	Display Selection Setting (diSP)	1. Press  to enter the parameter setting, the digit will be flashed. 2. Press  or  can modify Display Low Cut. Range: 0~9999 If this value is 10, while display is under 10, display value will show 0. 3. Press <b>ENT</b> to save the value and go to the next parameter.
	no	Roof Square Function Setting (Sqrt)	1. Press  to enter the parameter setting, the digit will be flashed. 2. Press  or  can open Roof Square Function. Range: no (Do Not Open), YES (Open) 3. Press <b>ENT</b> to save the value and go to the next parameter.
	rAtE	Display Selection Setting (FKEY)	1. Press  to enter the parameter setting, the digit will be flashed. 2. Press  or  can select lower Display Selection. Range: rAtE (Ratet), MAX,d (Max displacement), dEM (Displacement) 3. Press <b>ENT</b> to save the value and go to the next parameter.
	Min	Displacement Time Setting (dEM.t)	1. Press  to enter the parameter setting, the digit will be flashed. 2. Press  or  can select Displacement Time Unit. Range: Min (Minute), hour (Hour), dAY (Day), MonthH (Month) 3. Press <b>ENT</b> to save the value and go to the next parameter.
	00000	Pass Code Setting (P.Cod)	1. Press  to enter the parameter setting, the digit will be flashed. 2. Press  or  can modify Pass Code. Range: 0~19999 (Please do remember new Pass Code) 3. Press <b>ENT</b> to save the value and go to the next parameter.
	no	Key Lock Setting (LoCK)	1. Press  to enter the parameter setting, the digit will be flashed. 2. Press  or  can close Key Lock. Range: no (Do Not Close), YES (Close) 3. Press <b>ENT</b> to save the value and back to System Setting Group.



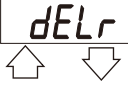











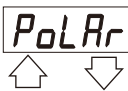

## 3.2 ALARM (roP) SETTING GROUP PROCEDURE

\* While Pass Code is correct, Press  can select Alarm Output Setting Group.

Display	Default	Name	Descriptions
	ALr	AL Indicator Selection Setting (indi)	1. Press  to enter the parameter setting, the digit will be flashed. 2. Press  or  can select AL Indicator selection. Range: ALr (Alarm for Rate), ALt (Alarm for Total) 3. Press <b>ENT</b> to save the value and go to the next parameter.
	0000	Pulse O/P Duty Cycle Setting (P.dUtY)	1. Press  to enter the parameter setting, the digit will be flashed. 2. Press  or  can modify Pulse O/P Cycle Setting. Range: 1~999 (msec) 3. Press <b>ENT</b> to save the value and go to the next parameter.
	rAtE	AL1 Selection Setting (AL.SEL)	1. Press  to enter the parameter setting, the digit will be flashed. 2. Press  or  can select AL1 Selection Setting. Range: rAtE (Rate), totAL (Total) 3. Press <b>ENT</b> to save the value and go to the next parameter.
	H	AL1 Action Setting (ACt1)	1. Press  to enter the parameter setting, the digit will be flashed. 2. Press  or  can select Alarm Action. Range: Hi ( $\geq$ Alarm Setpoint On), Lo ( $<$ Alarm Setpoint On) 3. Press <b>ENT</b> to save the value and back to A/O Group Setting.
	H	AL Rate Action Setting (ACtr)	
	H	AL Total Action Setting (ACtt)	
	00000	AL1 Hysteresis Setting (HYS1)	1. Press  to enter the parameter setting, the digit will be flashed. 2. Press  or  can modify Alarm Hysteresis. Range: 0~9999 Alarm will be turned off while display value is higher or lower (depends on Alarm Action) Alarm Setpoint +/- Hysteresis. 3. Press <b>ENT</b> to save the value and go to the next parameter.
	00000	AL Rate Hysteresis Setting (HYSr)	
	00000	AL Total Hysteresis Setting (HYS1)	
	00000	AL1 Run Delay Setting (dEL1)	1. Press  to enter the parameter setting, the digit will be flashed. 2. Press  or  can modify Alarm Run Delay. Range: 0~99 (sec) Alarm will be turned on after this setting (sec). 3. Press <b>ENT</b> to save the value and go to the next parameter.
	00000	AL Rate Run Delay Setting (dELr)	
	00000	AL Total Run Delay Setting (dELt)	

















### 3.3 A/O (AoP) SETTING GROUP PROCEDURE

\* While Pass Code is correct, Press  can select A/O Setting Group.

Display	Default	Name	Descriptions
	rAtE	A/O Selection Setting (Ao.SEL)	1. Press  to enter the parameter setting, the digit will be flashed. 2. Press  or  can select Analog Output Selection. Range: rAtE (Rate), totAL (Total) 3. Press <b>ENT</b> to save the value and go to the next parameter.
	no	A/O Polarity Setting (PoLAR)	1. Press  to enter the parameter setting, the digit will be flashed. 2. Press  or  can select A/O Polarity. Range: no (Positive Pole O/P; 0~10 Vdc), YES (Positive & Negative Pole O/P; -10~+10 Vdc) 3. Press <b>ENT</b> to save the value and back to A/O Setting Group.
	00000	A/O Low Scale Setting (AnLo)	1. Press  to enter the parameter setting, the digit will be flashed. 2. Press  or  can modify A/O Low Scale. Range: -199999~999999 If this value is 0, while display is 0, output signal will be 4 mAdc. 3. Press <b>ENT</b> to save the value and go to the next parameter.
	99999	A/O Hi Scale Setting (AnHi)	1. Press  to enter the parameter setting, the digit will be flashed. 2. Press  or  can modify A/O Hi Scale. Range: -199999~999999 If this value is 100, while display is 100, output signal will be 20 mAdc. 3. Press <b>ENT</b> to save the value and go to the next parameter.

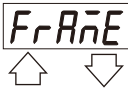
### 3.4 RS-485 (doP) SETTING GROUP PROCEDURE

\* While Pass Code is correct, Press  can select RS-485 Setting Group.

Display	Default	Name	Descriptions
	00000	Address Setting (Addr)	1. Press  to enter the parameter setting, the digit will be flashed. 2. Press  or  can modify Address. Range: 0~255 3. Press <b>ENT</b> to save the value and go to the next parameter.
	38400	Baud Rate Setting (bAUd)	1. Press  to enter the parameter setting, the digit will be flashed. 2. Press  or  can select Baud Rate. Range: 38400, 19200, 9600, 4800 (bps) 3. Press <b>ENT</b> to save the value and go to the next parameter.
	n.8.2.	Parity Check Setting (PAri)	1. Press  to enter the parameter setting, the digit will be flashed. 2. Press  or  can select Parity Check. Range: n.8.2., n.8.1., EvEn, odd 3. Press <b>ENT</b> to save the value and go to the next parameter.
	no	Frame Setting (FrAME)	1. Press  to enter the parameter setting, the digit will be flashed. 2. Press  or  can select Frame. Range: no (Hi to Lo), YES (Lo to Hi) 3. Press <b>ENT</b> to save the value and back to RS-485 Setting Group.



# 4.1 MODBUS RTU MODE PROTOCOL ADDRESS TABLE

\* Data form: 16 / 32 bit, +/-8000~7FFF(-32768~32767), 800000007FFFFFFF(-2147483648~2147483647)

Modbus	Hex	Name	Act	Descriptions
40001	0000	ID	R	Model number identification; GTA is 24
40002	0001	STATUS	R	Current alarm output & external control input status, range: 0000~00F0 (0~240) (Bit 7: P/O, Bit 6: ALT, Bit 5: ALR, Bit 4: AL1) 0:Off, 1:On
40003	0002	INDEX	R/W	Index, range: 0000~002F (0~48) [Please refer section 4.2 for detail.]
40004	0003	POLAR	R/W	A/O polarity setting, range: 0000~0001 (0~1); 0:No, 1:YES
40005	0004	INDI	R/W	AL indicator selection setting, range: 0000~0001 (0~1); 0:ALR, 1:ALT
40006	0005	DISP	R/W	Display selection setting, range: 0000~0002 (0~2); 0:Rate, 1:Max.D, 2:Deml
40007	0006	DEM.T	R/W	Displacement time unit setting, range: 0000~0003 (0~3); 0:Min, 1:Hour, 2:Day, 3:Month
40008	0007	BAUD	R/W	Baud rate setting, range: 0000~0003 (0~3); 0:38400, 1:19200, 2:9600, 3:4800
40009	0008	PARI	R/W	Parity check setting, range: 0000~0003 (0~3); 0:n.8.2., 1:n.8.1., 2:EvEn, 3:odd
40010	0009	FRAME	R/W	Frame setting, range: 0000~0001 (0~1); 0:No, 1:YES
40011	000A	LOCK	R/W	Key lock setting, range: 0000~0001 (0~1); 0:No, 1:YES
40012	000B			
40013	000C	SQRT	R/W	Root square function setting, range: 0000~0001 (0~1); 0:No, 1:YES
40014	000D	AL.SEL	R/W	Alarm 1 selection setting, range: 0000~0001 (0~1); 0:Rate, 1:Total
40015	000E	AO.SEL	R/W	A/O selection setting, range: 0000~0001 (0~1); 0:Rate, 1:Total
40016	000F	ACT1	R/W	Alarm 1 action setting, range: 0000~0001 (0~1); 0:Hi, 1:Lo
40017	0010	ACTR	R/W	Alarm rate action setting, range: 0000~0001 (0~1); 0:Hi, 1:Lo
40018	0011	ACTT	R/W	Alarm total action setting, range: 0000~0001 (0~1); 0:Hi, 1:Lo
40019	0012	DPR	R/W	Rate decimal point setting, range: 0000~0004 (0~4); 0:10 <sup>0</sup> , 1:10 <sup>1</sup> , 2:10 <sup>2</sup> , 3:10 <sup>3</sup> , 4:10 <sup>4</sup>
40020	0013	DPT	R/W	Decimal point setting, range: 0000~0009 (0~9); 0:10 <sup>0</sup> , 1:10 <sup>1</sup> , 2:10 <sup>2</sup> , 3:10 <sup>3</sup> , 4:10 <sup>4</sup> , 5:10 <sup>5</sup> , 6:10 <sup>6</sup> , 7:10 <sup>7</sup> , 8:10 <sup>8</sup> , 9:10 <sup>9</sup>
40021	0014	C.TIME	R/W	Total time unit setting, range: 0000~0004 (0~4); 0:Sec, 1:Min, 2:Hour, 3:Day, 4:Month
40022	0015	AVG	R/W	Display average setting, range: 0001~0063 (1~99)
40023	0016	LCUT	R/W	Display low cut setting, range: 0000~0063 (0~99)
40024	0017	ADDR	R/W	Address setting, range: 0000~00FF (0~255)
40025	0018	DEL1	R/W	Alarm 1 run delay setting, range: 0000~0063 (0~99)
40026	0019	DEL2	R/W	Alarm rate run delay setting, range: 0000~0063 (0~99)
40027	001A	DEL3	R/W	Alarm total run delay setting, range: 0000~0063 (0~99)
40028	001B	HYS1	R/W	Alarm 1 hysteresis setting, range: 0000~0063 (0~99)
40029	001C	HYS2	R/W	Alarm rate hysteresis setting, range: 0000~0063 (0~99)
40030	001D	HYS3	R/W	Alarm total hysteresis setting, range: 0000~0063 (0~99)
40031	001E	CODE	R/W	Pass code setting, range: 0000~4E1F (0~19999)
40032	001F	P.DUTY	R/W	Pulse output duty cycle setting, range: 0001~03E7 (1~999)
40033	0020	AZERO	R/W	A/O zero adjustment, range: D8F1~270F (-9999~9999)
40034	0021	ASpan	R/W	A/O span adjustment, range: D8F1~270F (-9999~9999)
40035	0022	SCALE	R/W	Total scale setting, range: 00000001~0001869F (1~99999) Hi Bit
40036	0023		R/W	Total scale setting, range: 00000001~0001869F (1~99999) Low Bit
40037	0024	DSPL	R/W	Display low scale setting, range: 00000000~0001869F (0~99999) Hi Bit
40038	0025		R/W	Display low scale setting, range: 00000000~0001869F (0~99999) Low Bit
40039	0026	DSPH	R/W	Display hi scale setting, range: 00000000~0001869F (0~99999) Hi Bit
40040	0027		R/W	Display hi scale setting, range: 00000000~0001869F (0~99999) Low Bit
40041	0028	ALR	R/W	Rate alarm setting, range: 00000000~0001869F (0~99999) hi Bit
40042	0029		R/W	Rate alarm setting, range: 00000000~0001869F (0~99999) Low Bit
40043	002A	AL1	R/W	Alarm 1, range: 0000000000000000~0000002540BE3FF (0~999999999)
40044	002B		R/W	Alarm 1, range: 0000000000000000~0000002540BE3FF (0~999999999)
40045	002C		R/W	Alarm 1, range: 0000000000000000~0000002540BE3FF (0~999999999)
40046	002D		R/W	Alarm 1, range: 0000000000000000~0000002540BE3FF (0~999999999)

Modbus	Hex	Name	Act	Descriptions
40047	002E	ALT	R/W	Total alarm, range: 0000000000000000~00000002540BE3FF (0~999999999)
40048	002F		R/W	Total alarm, range: 0000000000000000~00000002540BE3FF (0~999999999)
40049	0030		R/W	Total alarm, range: 0000000000000000~00000002540BE3FF (0~999999999)
40050	0031		R/W	Total alarm, range: 0000000000000000~00000002540BE3FF (0~999999999)
40051	0032	ANLO	R/W	A/O low scale setting, range: 0000000000000000~00000002540BE3FF (0~999999999)
40052	0033		R/W	A/O low scale setting, range: 0000000000000000~00000002540BE3FF (0~999999999)
40053	0034		R/W	A/O low scale setting, range: 0000000000000000~00000002540BE3FF (0~999999999)
40054	0035		R/W	A/O low scale setting, range: 0000000000000000~00000002540BE3FF (0~999999999)
40055	0036	ANHI	R/W	A/O hi scale setting, range: 0000000000000000~00000002540BE3FF (0~999999999)
40056	0037		R/W	A/O hi scale setting, range: 0000000000000000~00000002540BE3FF (0~999999999)
40057	0038		R/W	A/O hi scale setting, range: 0000000000000000~00000002540BE3FF (0~999999999)
40058	0039		R/W	A/O hi scale setting, range: 0000000000000000~00000002540BE3FF (0~999999999)
40059	003A	TOTALIZE	R/W	Total display, range: 0000000000000000~00000002540BE3FF (0~999999999)
40060	003B		R/W	Total display, range: 0000000000000000~00000002540BE3FF (0~999999999)
40061	003C		R/W	Total display, range: 0000000000000000~00000002540BE3FF (0~999999999)
40062	003D		R/W	Total display, range: 0000000000000000~00000002540BE3FF (0~999999999)
40063	003E	MAX.D	R/W	Max. displacement display, range: 00000000~0001869F (0~99999) Hi Bit
40064	003F		R/W	Max. displacement display, range: 00000000~0001869F (0~99999) Low Bit
40065	0040	DEMAND	R	Displacement display, range: 00000000~0001869F (0~99999) Hi Bit
40066	0041		R	Displacement display, range: 00000000~0001869F (0~99999) Low Bit
40067	0042	RATE	R	Rate display, range: 00000000~0001869F (0~99999) Hi Bit
40068	0043		R	Rate display, range: 00000000~0001869F (0~99999) Low Bit

## 4.2 INDEX CODE SUPPLEMENT

\* The following codes are for hexadecimal.

Page / Name	Page / Name	Page / Name	Page / Name	Page / Name
00: SYS	01: roP	02: AoP	03: doP	04: P.Cod
05: dZEro	06: dSPAn	07: E-00	08: PoLAr	09: indi
0A: diSP	0B: dEM.t	0C: bAUd	0D: ACT1	0E: FrAME
0F: LoCK	10:	11: Sqrt	12: AL.SEL	13: Ao.SEL
14: ACT1	15: ACtr	16: ACtt	17: dPr	18: dPt
19: C.tIME	1A: AvG	1B: LCUt	1C: Addr	1D: dEL1
1E: dELr	1F: dELt	20: HYS1	21: HYSr	22: HYSst
23: CodE	24: P.dUtY	25: AZEro	26: ASPAn	27: SCALE
28: dSPL	29: dSPH	2A: ALr	2B: AL1	2C: ALt
2D: AnLo	2E: AnHi	2F: Current Display		