



CHANNEL8A-N 96 x 96 DIN 1/4 8 CHANNEL ANALOG SCANNER



CHANNEL8A-N 8 Channel Analog Scanner

- 320 x 240 pixel TFT LCD display
- 8 Analog inputs
- ON-OFF control
- Relay or (pnp "source") transistor output
- Sensor error detection
- Adjustable temperature offset
- 3 Different alarm and pre-alarm types for each channel (High, Low and Band Alarms)
- User defined channel labels
- Display scan modes
- Operating with Real Time Clock (RTC)
- ModBus RTU communication protocol (RS-232, RS-485 and Ethernet communication)
- Data Logging to USB Flash Memory
- Adjustable data logging time interval
- Password protection for programming mode

CHANNEL8A-N series 8 channel analog scanner devices are designed for measuring and logging temperature. They can be used in many applications with their, alarm outputs, selectable alarm functions, RS-232 / RS-485 / Ethernet / USB communications.

SPECIFICATIONS

INPUT

Analog Inputs : 0-20mA / 4-2 mA and 0-10VDC Analogue
Accuracy : ± 0.25% of full scale
Sampling Time : 400 ms
Resolution : 14 Bits
Input Resistance : 100Ω for 0-20mA input and 68kΩ for 0-10V input

OUTPUT

Relay : Resistive Load 5A@250V V
 (Electrical Life : 100.000 operation (Full Load)
Transistor : PNP(source) type transistor output (Max.1A@24V Z)

DISPLAY

LCD Display : 320x240 pixel TFT LCD

POWER SUPPLY

100 - 240 V V (-%15 / +%10) 50/60 Hz. 7VA
 24 V V (-%15 / +%10) 50/60 Hz. 7VA
 24 V Z (-%15 / +%10) 7W
 (It must be determined in order.)

ENVIRONMENTAL RATINGS

Operating Temperature : 0...50°C
Humidity : 0-90%RH (none condensing)
Protection Class : IP65 at front, IP20 at rear

PHYSICAL SPECIFICATIONS

Weight : 400 gr.
Dimension : 96 x 96 mm, Depth:96 mm
Panel Cut-Out : 92 x 92 mm

Electrical Wiring Diagram

Device with Relay Outputs

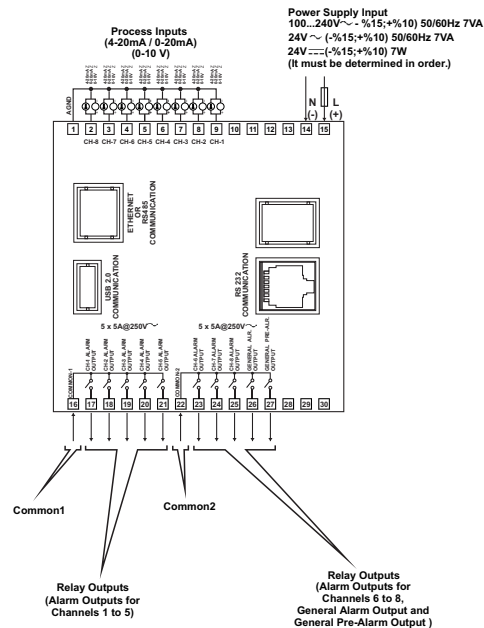

CH = CHANNEL

RS485, Ethernet and USB communications are optional

Device with Transistor Outputs

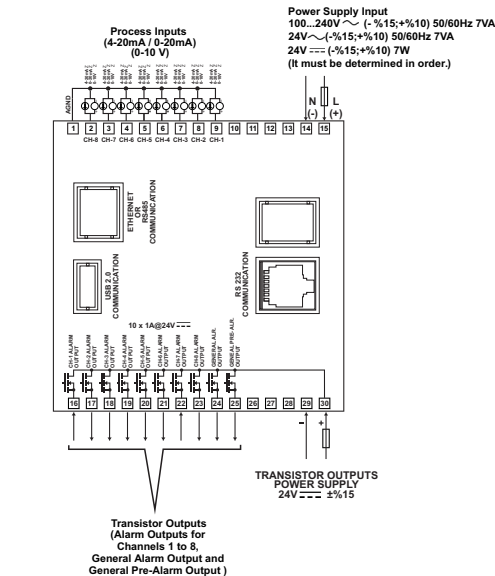

CH = CHANNEL

RS485, Ethernet and USB communications are optional

Front View and Dimensions of CHANNEL8A-N

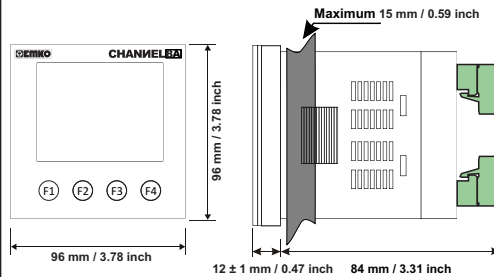

Panel Cut-Out

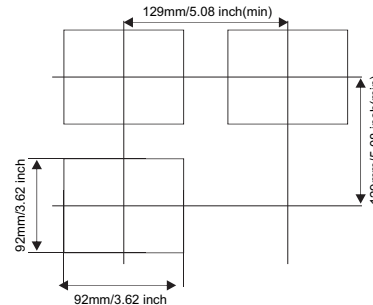

Panel Mounting

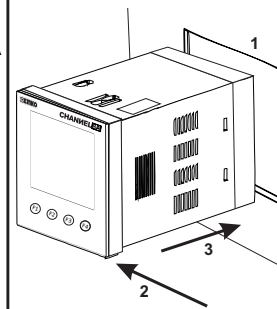

- 1-Before mounting the device in your panel, make sure that the cut-out is of the right size.
- 2-Check front panel gasket position
- 3-Insert the device through the cut-out from the rear side. If the mounting clamps are on the unit, put out them before inserting the unit to the panel.

Installation Fixing Clamp

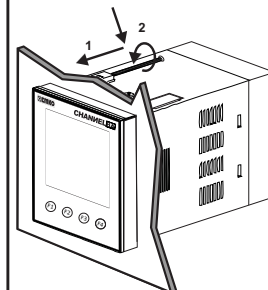

- The unit is designed for panel mounting.
- 1-Insert the unit in the panel cut-out from the front side.
 - 2- Insert the mounting clamps to the holes that located top and bottom sides of device and screw up the fixing screws until the unit completely immobile within the panel.

Removing from the Panel

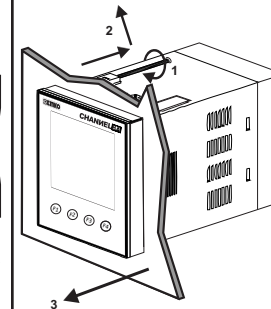

- 1-Loosen the screws.
- 2-Pull mounting clamps from top and bottom fixing sockets.
- 3-Pull the unit through the front side of the panel

Definition of Front Panel

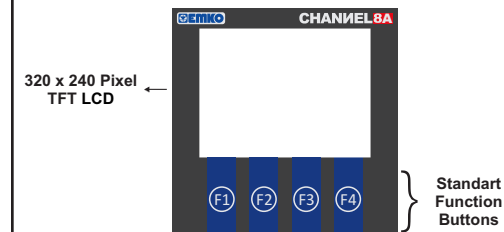

- MENU BUTTON**
Used to access Menu page.
- AUTO BUTTON**
Used to auto-scan pages.
- ENTER BUTTON**
Used to go in to selected page, to make parameter's cell available to change and to confirm parameter's change.
- BACK BUTTON**
Used to go back to previous menu and to cancel parameter's change.
- UP BUTTON**
Used to go up in menus and lists and also used to increase parameter's value.
- DOWN BUTTON**
Used to go down in menus and lists and also used to decrease parameter's value.
- LEFT BUTTON**
Used to go left in menus.
- RIGHT BUTTON**
Used to go right in menus.
- DELETE BUTTON**
Used to erase logs on the screen.



SETTINGS



ADVANCE SETTINGS



LOGS



LANGUAGE

Main Operation Screens Definition

If the display type parameter value **Screen Type = MULTIPLE**

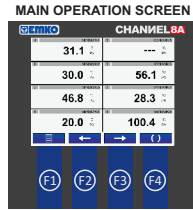
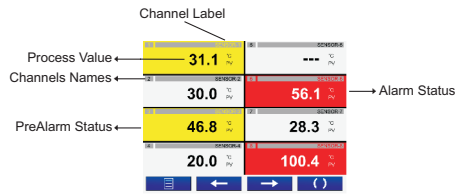

i If the display scan parameter value **Screen Change = ENABLE**, each main operation screen is showing on LCD screen during time defined by **Change Time** parameter value.

If the display type parameter value **Screen Type = SINGLE**

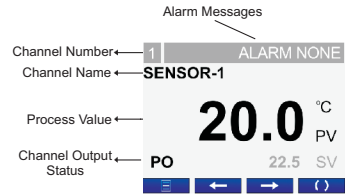

MAIN OPERATION (CHANNEL-1 SCREEN)

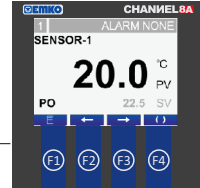

Press number F2 or F3 buttons for accessing the relevant channel screen.

MAIN OPERATION (CHANNEL-4 SCREEN)

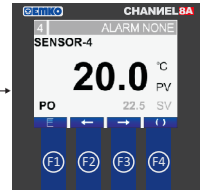

i If more than one alarm messages is present, each alarm message is showing on LCD screen during 1 second.

i If the display scan parameter value **Screen Change = ENABLE**, each main operation screen is showing on LCD screen during time defined by **Change Time(sec)** parameter value

Accessing to the Operator Parameter Pages

MAIN OPERATION SCREEN

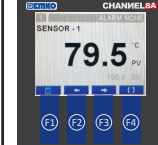

When the F1 menu button is pressed while the main screen is on the page, the menu page is displayed.

MENU SCREEN



Press F1 or F2 direction buttons to move to the Settings tab.

OPERATOR PARAMETERS PASSWORD SCREEN



Press F3 button. If password is different from 0, password screen opens.

OPERATOR PARAMETERS PASSWORD SCREEN



Enter the password value using the F1 and F2 buttons.

OPERATOR PARAMETERS PASSWORD INPUT SCREEN



Confirm the characters one by one by pressing F3 button. Once you have confirmed the last character, you will proceed to the operator parameters screen.

OPERATOR PARAMETERS (CHANNEL-1)

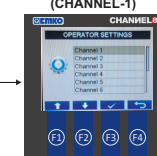

Press the F1 and F2 buttons to highlight the channel and press the F3 button.

OPERATOR PARAMETERS (CHANNEL-1 PARAMETERS)



Select the relevant parameter with the F1 and F2 buttons.

PARAMETERS CHANGE

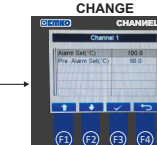

Press the F3 button to select the parameter.

PARAMETERS CHANGE

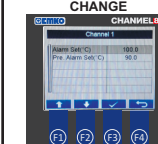

Use the F1 and F2 buttons to change the value of the parameter.

OPERATOR PARAMETERS (CHANNEL-1 PARAMETERS)

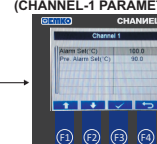

Press the F3 button to save the parameter value.

Accessing to the Technician Parameter Pages

MAIN OPERATION SCREEN

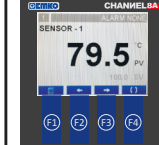

When the F1 menu button is pressed while the main screen is on the page, the menu page is displayed.

MENU SCREEN



Press F1 or F2 direction buttons to move to the Advanced Settings tab.

TECHNICIAN PARAMETERS PASSWORD SCREEN

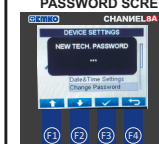

Press F3 button. If password is different from 0, password screen opens.

TECHNICIAN PARAMETERS PASSWORD SCREEN



Enter the password value using the F1 and F2 buttons.

TECHNICIAN PARAMETERS PASSWORD INPUT SCREEN

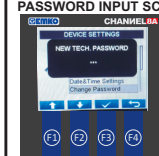

Confirm the characters one by one by pressing F3 button. Once you have confirmed the last character, you will proceed to the operator parameters

TECHNICIAN PARAMETERS (CONTROL PARAMETERS)

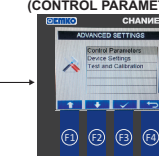

Use the F1 and F2 buttons to scroll to the Control parameters and press the F3 button.

TECHNICIAN PARAMETERS (CHANNEL-1)



Select the relevant channel with the F1 and F2 buttons.

TECHNICIAN PARAMETERS (CHANNEL-1 PARAMETERS)

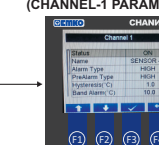

Press the F3 button to select the parameter.

PARAMETERS CHANGE



Use the F1 and F2 buttons to change the value of the parameter. Press the F3 button to save the parameter value.

DEVICE SETTINGS (RS232 SETTINGS)

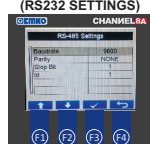

With the F1 and F2 buttons you can select and change the RS232 parameters. Use the F3 button to save.

DEVICE SETTINGS (RS485 SETTINGS)

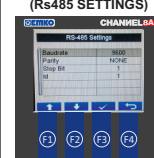

With the F1 and F2 buttons you can select and change the RS485 parameters. Use the F3 button to save.

DEVICE SETTINGS (USB SETTINGS)

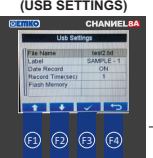

With the F1 and F2 buttons you can select and change the USB parameters. Use the F3 button to save.

DEVICE SETTINGS (ETHERNET SETTINGS)

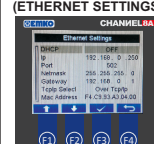

With the F1 and F2 buttons you can select and change the ETHERNET parameters. Use the F3 button to save.

DEVICE SETTINGS (DATE TIME SETTINGS)

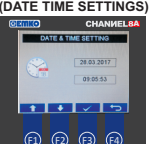

With the F3 button you can select the Date and Time parameters and you can change the value with the F1, F2 buttons.

DEVICE SETTINGS (PASSWORD CHANGE)



Use the F1 and F2 buttons to change the value of the parameter. Confirm the characters one by one by pressing F3 button.

DEVICE SETTINGS (DEFAULT SETTINGS)

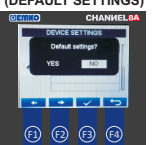

Use the F1 button to move to the "YES" tab and press the F3 button. In 1-3 seconds the device will return to factory settings.

i If the device has an optional ETHERNET communication then ETHERNET page is observed, otherwise this page is not observed.

i If the device has an optional RS485 communication then RS 485 page is observed. If the device has an optional USB communication then USB page is observed.

i If no operation is performed for 20 seconds in operator or technician parameters section, device turns to main operation screen automatically.

Operator Pages Parameters Definitions

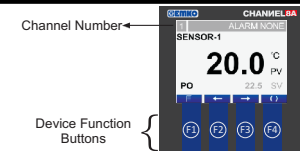

Alarm Set
Alarm set value for selected channel is can be adjusted according to this parameter. It can be adjust between -200 °C to +650 °C.

Pre-Alarm Set
Pre-Alarm set value for selected channel is can be adjusted according to this parameter. It can be adjust between -200 °C to +650 °C.

Unit Select
Type of unit value is adjusted according to this parameter for selected channel which is shown on display. The value of parameter °C, Bar, Ph, %, mm, m.

Operator Password Change
Operator Password for device is adjusted by this parameter.

i If no operation is performed for 20 seconds in operator parameters section, device turns to main operation screen automatically.

Technician Pages Parameters Definitions

Technician Parameters
Channel Status
 Channel is enabled and disabled by this parameter. If channel is selected as a disabled this channel is can not be observed in main operation screen for single view mode, channel alarm is not be controlled and analogue value for this channel is can not be recording on USB file. It can be adjust between 0 to 1. If parameter value,
 0 = DISABLE
 1 = ENABLE
Channel Name "Channels label definition"
 All channels have their own label, is displayed in main operation screen. channel labels is can be adjusted by this parameter. Channel labels are can be adjusted maximum 10 characters.

Alarm Type
 Alarm type for selected channel is can be adjusted according to this parameter. It can be adjust between 0 to 2. Parameter values;
 0 = LOW 1 = HIGH 2 = BAND

PreAlarm Type
 Pre-Alarm type for selected channel is can be adjusted according to this parameter. It can be adjust between 0 to 2. Parameter values;
 0 = LOW 1 = HIGH 2 = BAND

Hysteresis
 Hysteresis parameter value for Alarm and Pre-Alarm is can be adjusted by this parameter. It can be adjust between -400 °C to +400 °C.

Band Alarm
 Bandwidth for Band alarm is can be adjusted by this parameter value. It can be adjust between -400 °C to +400 °C.

Offset
 Process offset value for selected channel is can be adjusted by this parameter. It can be adjust between -50.0 °C to +50.0 °C.

Sensor Alarm
 Sensor break alarm for selected channel is can be disable or enable by this parameter. It can be adjust between 0 to 1. Parameter values;
 0 = DISABLE
 1 = ENABLE

Calib. Low
 Calibration Low value for selected channel can be adjusted according to this parameter.

Calib. High
 Calibration High value for selected channel can be adjusted according to this parameter.

Sensor Type
 Analogue input signal to be applied according to this parameter for selected channel which is shown on Display.
 0 = 4-20 mA 1 = 0-20 mA 2 = 0-10 V

Control Parameters- Other Parameters
Screen Type
 Main operation screen type is adjusted by this parameter. It can be adjust between 0 to 1. Parameter values;
 0 = MULTIPLE
 1 = SINGLE

Screen Change
 Display channel scanner mode is adjusted by this parameter. It can be adjust between 0 to 1. Parameter values;
 0 = DISABLE
 1 = ENABLE

Change Time(sec)
 Display scan period is adjusted by this parameter. All main operation screen is displayed during time defined by this parameter. It can be adjust between 1 to 3600 secs.

BackLightOnLevel
 Display backlight is can be controlled by this parameter value. It can be adjust between 50 to 100.

BackLightOffLevel
 ECO mode for backlight; in case off selection no backlight. This parameter is can be adjusted from 1 to 100.

BackLightOffTime
 Time for the access to economic backlight mode. This parameter is can be adjusted from 10 to 300.

Device Settings - RS-232 Settings
Baudrate
 Modbus communication baudrate for RS232 is can be adjusted by this parameter. It can be adjust between 0 to 5. Parameter values;
 0 = 4800 3 = 38400
 1 = 9600 4 = 57600
 2 = 19200 5 = 115200

Parity
 Modbus communication parity bit for RS232 is can be adjusted by this parameter. It can be adjust between 0 to 2. Parameter values;
 0 = NONE
 1 = ODD
 2 = EVEN

Stop Bit
 Modbus communication stop bit for RS232 is can be adjusted by this parameter. It can be adjust between 1 to 2. Parameter values;
 1 = 1 Stop bit
 2 = 2 Stop bits

Id
 Modbus communication device ID for RS232 is can be adjusted by this parameter. This parameter value is can be adjusted from 1 to 247.

Device Settings - RS-485 Settings
Baudrate
 Modbus communication baudrate for RS485 is can be adjusted by this parameter. It can be adjust between 0 to 5. Parameter values;
 0 = 4800
 1 = 9600
 2 = 19200
 3 = 38400
 4 = 57600
 5 = 115200

Parity
 Modbus communication parity bit for Rs485 is can be adjusted by this parameter. It can be adjust between 0 to 2. Parameter values;
 0 = NONE
 1 = ODD
 2 = EVEN

Stop Bit
 Modbus communication stop bit for Rs485 is can be adjusted by this parameter. It can be adjust between 1 to 2. Parameter values;
 1 = 1 Stop bit
 2 = 2 Stop bits

Id
 Modbus communication device ID for Rs485 is can be adjusted by this parameter. This parameter value is can be adjusted from 1 to 247.

Device Settings - USB Settings
File Name
 USB file name for recording analogue values is can be adjusted by this parameter. File name can be adjusted maximum 10 characters. Recording file on usb is "csv" format and all data is seperated each other with tab. Example file format is explained below.

Label
 When the analogue values are recorded on USB file, user can be defined label for this recording. Label can be adjusted maximum 10 characters. Label are recorded at the end of every lines of file.

Date Record
 When the analogue values are recorded on USB file, user can be save the recording time on the file. Recording time is recorded at the beginning of every lines of file. It can be adjust between 0 to 1. Parameter values;
 0 = DISABLE
 1 = ENABLE

Record Time(sec)
 Record time interval is can be adjusted by this parameter. Analogue values are recorded on USB file with this time interval. It can be adjust between 0 to 3600 secs. If this parameter value is 0 usb recording is disabled.

Flash Memory "USB Flash Memory Stick Detected Test"
 Detection of the USB memory device being inserted is tested with this parameter. When the USB memory device is plugged in, the message "OK" is displayed.

Internal Recording
 The device can record in memory. When a USB memory is inserted, the recordings are transferred to the USB memory with the file name containing the current date and time.(Exp: 2017-07-30-09-08-12-CHAN8.txt) icon and transaction status (%) are displayed on the screen until the transfer is complete. If you want to eject the USB memory during transfer or recording; Press the F4 button for 5 seconds and the USB memory must be removed (within 5 seconds) before the icon on the screen disappears. If the USB stick is not removed during this time, the transfer will resume from where it left off.

Not: The device can store up to (Record time x 2) daily memos in its memory.

USB Recording File Example

2011-06-23-17:26:09	130.6	129.1	130.5	129.5	130.0	129.9	130.3	129.1	SAMPLE
2011-06-23-17:26:10	130.6	129.1	130.5	129.5	130.0	129.9	130.3	129.1	SAMPLE
2011-06-23-17:26:12	130.6	129.1	130.5	129.5	130.0	129.9	130.3	129.1	SAMPLE
2011-06-23-17:26:13	130.6	129.1	130.5	129.5	130.0	129.9	130.3	129.1	SAMPLE

Recording Time CH-1 Value CH-2 Value CH-3 Value CH-4 Value CH-5 Value CH-6 Value CH-7 Value CH-8 Value Label

Device Settings - ETHERNET Settings
DHCP
 DHCP is an automatic configuration protocol used on IP networks. If DHCP is enable, device is adjust our ethernet communication configuration parameters (IP, Netmask, Gateway) dynamically for your network system. If DHCP is disable, you must adjust ethernet configuration parameters (IP, Netmask, Gateway) for your network system. It can be adjust between 0 to 1. Parameter Values;
 0 = DHCP DISABLE
 1 = DHCP ENABLE

IP No
 IP address for ethernet communication is can be adjusted by this parameter. If DHCP is selected as a enable there is no need to adjust to this parameter, if DHCP is selected as a disable then user must adjust this parameter.

Port No
 Ethernet port number is can be adjusted by this parameter.

Netmask
 Subnet mask for ethernet communication is can be adjusted by this parameter. If DHCP is selected as a enable there is no need to adjust to this parameter, if DHCP is selected as a disable then user must adjust this parameter according to the their own network system.

Gateway
 Gateway for ethernet communication is can be adjusted by this parameter. If DHCP is selected as a enable there is no need to adjust to this parameter, if DHCP is selected as a disable then user must adjust this parameter according to the their own network system.

TcpIp Selection
 TCP/IP Protocol is can be adjusted by this parameter. It can be adjust between 0 to 1.
 0 = Modbus RTU Over TCP/IP
 1 = Modbus RTU TCP/IP

Device Settings - Date and Time Settings
 Date and Time for device is adjusted by this parameter.

Device Settings - Password Change
 Technician Password for device is adjusted by this parameter.

Device Settings-Default Settings
 This section is used to return default settings back.

Device Settings - Software Update
 It allows you to update the device's software with a USB flash memory.

Logs
 In this page, events logs are shown.



Language Selection
 In this page, the language is selected for the device.



Operation Graphics of Alarm and Pre-Alarm Types

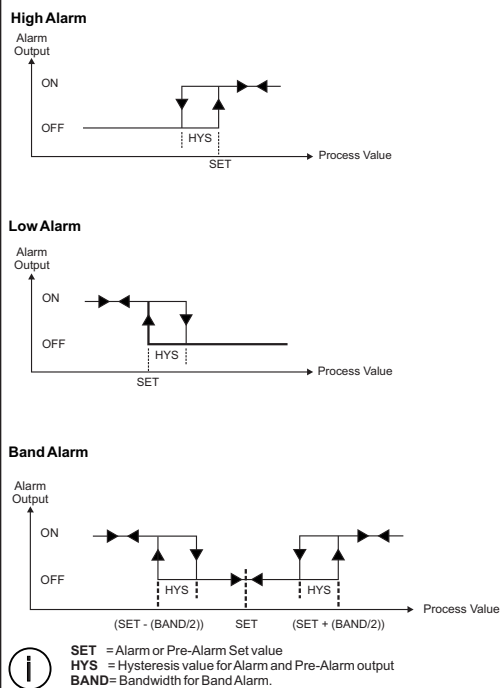

Modbus Addresses

Output Status Addresses

Outputs Status Addresses	Unit	Address
CH-1 ALARM OUT	-	00001
CH-2 ALARM OUT	-	00002
CH-3 ALARM OUT	-	00003
CH-4 ALARM OUT	-	00004
CH-5 ALARM OUT	-	00005
CH-6 ALARM OUT	-	00006
CH-7 ALARM OUT	-	00007
CH-8 ALARM OUT	-	00008
GEN. ALR. OUT	-	00009
GEN.PRE.ALR. OUT	-	00010

Note-1: Outputs status are can be readed with modbus function-1 (read coils). Device's response for modbus function-1 is always 2 byte data although the modbus function request less than 9 outputs port.

Process Values Addresses

Process Values Addresses	Unit	Address
CH-1 P. VALUE	°C/Ph/Bar	30001
CH-2 P. VALUE	°C/Ph/Bar	30002
CH-3 P. VALUE	°C/Ph/Bar	30003
CH-4 P. VALUE	°C/Ph/Bar	30004
CH-5 P. VALUE	°C/Ph/Bar	30005
CH-6 P. VALUE	°C/Ph/Bar	30006
CH-7 P. VALUE	°C/Ph/Bar	30007
CH-8 P. VALUE	°C/Ph/Bar	30008

Note-2: Process values are can be readed with modbus function-4 (read input register). Because of the process values are displayed on LCD screen with point, the reading values from modbus is 10 times than the real values.

Parameters Modbus Addresses

Parameter Values Addresses	Unit	Address
CH-1 NAME	Channel-1 Name	String 42000 - 42004
CH-2 NAME	Channel-2 Name	String 42005 - 42009
CH-3 NAME	Channel-3 Name	String 42010 - 42014
CH-4 NAME	Channel-4 Name	String 42015 - 42019
CH-5 NAME	Channel-5 Name	String 42020 - 42024
CH-6 NAME	Channel-6 Name	String 42025 - 42029
CH-7 NAME	Channel-7 Name	String 42030 - 42034
CH-8 NAME	Channel-8 Name	String 42035 - 42039
FILE NAME	USB File Name	String 42040 - 42044
LABEL	USB Label	String 42045 - 42049
CH-1 ALARM SET	Channel-1 Alarm Set Value	(+) °C/Ph/Bar 42050
CH-1 PRE A. SET	Channel-1 Prealarm Set Value	(+) °C/Ph/Bar 42051
CH-1 HYSTERESIS	Channel-1 Hysteresis Value	(+) °C/Ph/Bar 42052
CH-1 BAND ALARM	Channel-1 Bandwidth Value	(+) °C/Ph/Bar 42053
CH-2 ALARM SET	Channel-2 Alarm Set Value	(+) °C/Ph/Bar 42054
CH-2 PRE A. SET	Channel-2 Prealarm Set Value	(+) °C/Ph/Bar 42055
CH-2 HYSTERESIS	Channel-2 Hysteresis Value	(+) °C/Ph/Bar 42056
CH-2 BAND ALARM	Channel-2 Bandwidth Value	(+) °C/Ph/Bar 42057
CH-3 ALARM SET	Channel-3 Alarm Set Value	(+) °C/Ph/Bar 42058
CH-3 PRE A. SET	Channel-3 Prealarm Set Value	(+) °C/Ph/Bar 42059
CH-3 HYSTERESIS	Channel-3 Hysteresis Value	(+) °C/Ph/Bar 42060
CH-3 BAND ALARM	Channel-3 Bandwidth Value	(+) °C/Ph/Bar 42061
CH-4 ALARM SET	Channel-4 Alarm Set Value	(+) °C/Ph/Bar 42062
CH-4 PRE A. SET	Channel-4 Prealarm Set Value	(+) °C/Ph/Bar 42063
CH-4 HYSTERESIS	Channel-4 Hysteresis Value	(+) °C/Ph/Bar 42064
CH-4 BAND ALARM	Channel-4 Bandwidth Value	(+) °C/Ph/Bar 42065
CH-5 ALARM SET	Channel-5 Alarm Set Value	(+) °C/Ph/Bar 42066
CH-5 PRE A. SET	Channel-5 Prealarm Set Value	(+) °C/Ph/Bar 42067
CH-5 HYSTERESIS	Channel-5 Hysteresis Value	(+) °C/Ph/Bar 42068
CH-5 BAND ALARM	Channel-5 Bandwidth Value	(+) °C/Ph/Bar 42069
CH-6 ALARM SET	Channel-6 Alarm Set Value	(+) °C/Ph/Bar 42070
CH-6 PRE A. SET	Channel-6 Prealarm Set Value	(+) °C/Ph/Bar 42071
CH-6 HYSTERESIS	Channel-6 Hysteresis Value	(+) °C/Ph/Bar 42072
CH-6 BAND ALARM	Channel-6 Bandwidth Value	(+) °C/Ph/Bar 42073
CH-7 ALARM SET	Channel-7 Alarm Set Value	(+) °C/Ph/Bar 42074
CH-7 PRE A. SET	Channel-7 Prealarm Set Value	(+) °C/Ph/Bar 42075
CH-7 HYSTERESIS	Channel-7 Hysteresis Value	(+) °C/Ph/Bar 42076
CH-7 BAND ALARM	Channel-7 Bandwidth Value	(+) °C/Ph/Bar 42077

CH-8 ALARM SET	Channel-8 Alarm Set Value (H)	°C/Ph/Bar	42078
CH-8 PRE A. SET	Channel-8 Prealarm Set Value (H)	°C/Ph/Bar	42079
CH-8 HYSTERESIS	Channel-8 Hysteresis Value (H)	°C/Ph/Bar	42080
CH-8 BAND ALARM	Channel-8 Bandwidth Value (H)	°C/Ph/Bar	42081
CH-1 KALIB. LOW	Ch-1 Calibration Low Point Value	-	42082
CH-1 KALIB. HIGH	Ch-1 Calibration High Point Value	-	42083
CH-2 KALIB. LOW	Ch-2 Calibration Low Point Value	-	42084
CH-2 KALIB. HIGH	Ch-2 Calibration High Point Value	-	42085
CH-3 KALIB. LOW	Ch-3 Calibration Low Point Value	-	42086
CH-3 KALIB. HIGH	Ch-3 Calibration High Point Value	-	42087
CH-4 KALIB. LOW	Ch-4 Calibration Low Point Value	-	42088
CH-4 KALIB. HIGH	Ch-4 Calibration High Point Value	-	42089
CH-5 KALIB. LOW	Ch-5 Calibration Low Point Value	-	42090
CH-5 KALIB. HIGH	Ch-5 Calibration High Point Value	-	42091
CH-6 KALIB. LOW	Ch-6 Calibration Low Point Value	-	42092
CH-6 KALIB. HIGH	Ch-6 Calibration High Point Value	-	42093
CH-7 KALIB. LOW	Ch-7 Calibration Low Point Value	-	42094
CH-7 KALIB. HIGH	Ch-7 Calibration High Point Value	-	42095
CH-8 KALIB. LOW	Ch-8 Calibration Low Point Value	-	42096
CH-8 KALIB. HIGH	Ch-8 Calibration High Point Value	-	42097
CH-1 INDICATOT UNIT	Channel-1 Indicatot Unit	-	42098
CH-2 INDICATOT UNIT	Channel-2 Indicatot Unit	-	42099
CH-3 INDICATOT UNIT	Channel-3 Indicatot Unit	-	42100
CH-4 INDICATOT UNIT	Channel-4 Indicatot Unit	-	42101
CH-5 INDICATOT UNIT	Channel-5 Indicatot Unit	-	42102
CH-6 INDICATOT UNIT	Channel-6 Indicatot Unit	-	42103
CH-7 INDICATOT UNIT	Channel-7 Indicatot Unit	-	42104
CH-8 INDICATOT UNIT	Channel-8 Indicatot Unit	-	42105
CH-1 ANG. INPUT TYPE	Channel-1 Analogue Input Type	-	42106
CH-2 ANG. INPUT TYPE	Channel-2 Analogue Input Type	-	42107
CH-3 ANG. INPUT TYPE	Channel-3 Analogue Input Type	-	42108
CH-4 ANG. INPUT TYPE	Channel-4 Analogue Input Type	-	42109
CH-5 ANG. INPUT TYPE	Channel-5 Analogue Input Type	-	42110
CH-6 ANG. INPUT TYPE	Channel-6 Analogue Input Type	-	42111
CH-7 ANG. INPUT TYPE	Channel-7 Analogue Input Type	-	42112
CH-8 ANG. INPUT TYPE	Channel-8 Analogue Input Type	-	42113
CH-1 ALARM TYPE	Channel-1 Alarm Type	-	42114
CH-1 PRE.A TYPE	Channel-1 Prealarm Type	-	42115
CH-1 SENSOR ALARM	Channel-1 SensorBreak Alarm	-	42116
CH-2 ALARM TYPE	Channel-2 Alarm Type	-	42117
CH-2 PRE.A TYPE	Channel-2 Prealarm Type	-	42118
CH-2 SENSOR ALARM	Channel-2 SensorBreak Alarm	-	42119
CH-3 ALARM TYPE	Channel-3 Alarm Type	-	42120
CH-3 PRE.A TYPE	Channel-3 Prealarm Type	-	42121
CH-3 SENSOR ALARM	Channel-3 SensorBreak Alarm	-	42122
CH-4 ALARM TYPE	Channel-4 Alarm Type	-	42123
CH-4 PRE.A TYPE	Channel-4 Prealarm Type	-	42124
CH-4 SENSOR ALARM	Channel-4 SensorBreak Alarm	-	42125
CH-5 ALARM TYPE	Channel-5 Alarm Type	-	42126
CH-5 PRE.A TYPE	Channel-5 Prealarm Type	-	42127
CH-5 SENSOR ALARM	Channel-5 SensorBreak Alarm	-	42128
CH-6 ALARM TYPE	Channel-6 Alarm Type	-	42129
CH-6 PRE.A TYPE	Channel-6 Prealarm Type	-	42130
CH-6 SENSOR ALARM	Channel-6 SensorBreak Alarm	-	42131
CH-7 ALARM TYPE	Channel-7 Alarm Type	-	42132
CH-7 PRE.A TYPE	Channel-7 Prealarm Type	-	42133
CH-7 SENSOR ALARM	Channel-7 SensorBreak Alarm	-	42134
CH-8 ALARM TYPE	Channel-8 Alarm Type	-	42135
CH-8 PRE.A TYPE	Channel-8 Prealarm Type	-	42136
CH-8 SENSOR ALARM	Channel-8 SensorBreak Alarm	-	42137
TECH. PW.	Technician Section Password	-	42138
OPR. PW.	Operator Section Password	-	42139
CH-1 I/O	Channel-1 Enable/Disable	-	42140
CH-2 I/O	Channel-2 Enable/Disable	-	42141
CH-3 I/O	Channel-3 Enable/Disable	-	42142
CH-4 I/O	Channel-4 Enable/Disable	-	42143
CH-5 I/O	Channel-5 Enable/Disable	-	42144
CH-6 I/O	Channel-6 Enable/Disable	-	42145
CH-7 I/O	Channel-7 Enable/Disable	-	42146
CH-8 I/O	Channel-8 Enable/Disable	-	42147
CH-1 P.V OFFSET	Channel-1 Process Offset (H)	°C/Ph/Bar	42148
CH-2 P.V OFFSET	Channel-2 Process Offset (H)	°C/Ph/Bar	42149
CH-3 P.V OFFSET	Channel-3 Process Offset (H)	°C/Ph/Bar	42150
CH-4 P.V OFFSET	Channel-4 Process Offset (H)	°C/Ph/Bar	42151

CH-5 P.V OFFSET	Channel-5 Process Offset (H)	°C/Ph/Bar	42152
CH-6 P.V OFFSET	Channel-6 Process Offset (H)	°C/Ph/Bar	42153
CH-7 P.V OFFSET	Channel-7 Process Offset (H)	°C/Ph/Bar	42154
CH-8 P.V OFFSET	Channel-8 Process Offset (H)	°C/Ph/Bar	42155
RS232 BAUDRATRE	RS232 Baudrate Selection	-	42156
RS232 PARITY	RS232 Parity Bit Selection	-	42157
RS232 STOP BIT	RS232 Stop Bit Selection	-	42158
RS232 ID	RS232 Device ID Value	-	42159
DSP. TYPE	Main Operation Screen Type	-	42160
DSP. SCAN	Display Scan ON/OFF	-	42161
SCAN TIME	Display Scan Period	Sec	42162
DSP BACKLIGHT	LCD Display Backlight Mode	-	42163
RS485 BAUDRATRE	RS485 Baudrate Selection	-	42164
RS485 PARITY	RS485 Parity Bit Selection	-	42165
RS485 STOP BIT	RS485 Stop Bit Selection	-	42166
RS485 ID	RS485 Device ID Value	-	42167
LANGUAGE	Device Language Selection	-	42168
SAVE TIME	USB Time Record Ena/Dis	-	42169
SAMPLE TIME	USB Record Time Interval	Sec	42170
DHCP	Dhcp Enable/Disable(**)	-	42183
ETH. PORT	Ethernet Port No(**)	-	42184
ETH. IP NO	Ethernet Ip No(**)	-	42185
ETH. NETMASK	Ethernet Netmask(**)	-	42187
ETH. GATEWAY	Ethernet Gateway(**)	-	42189
MAC.ADR.	Device Mac Address(**)	-	42191

(i) These parameters are displayed on LCD screen with point, so that the Parameters values are 10 times than the real values for modbus function.

(i) These parameters are only read for modbus function.

Installation

Before beginning installation of this product, please read the instruction manual and warnings below carefully.

- In package ,**
- One piece unit
 - Two pieces mounting clamps
 - One piece instruction manual

A visual inspection of this product for possible damage occurred during shipment is recommended before installation. It is your responsibility to ensure that qualified mechanical and electrical technicians install this product.

If there is danger of serious accident resulting from a failure or defect in this unit, power off the system and separate the electrical connection of the device from the system.

The unit is normally supplied without a power supply switch or a fuse. Use power switch and fuse as required.

Be sure to use the rated power supply voltage to protect the unit against damage and to prevent failure.

Keep the power off until all of the wiring is completed so that electric shock and trouble with the unit can be prevented.

Never attempt to disassemble, modify or repair this unit. Tampering with the unit may result in malfunction, electric shock or fire.

Do not use the unit in combustible or explosive gaseous atmospheres.

During the equipment is putted in hole on the metal panel while mechanical installation some metal burrs can cause injury on hands, you must be careful.

Montage of the product on a system must be done with it's fixing clamps. Do not do the montage of the device with inappropriate fixing clamp. Be sure that device will not fall while doing the montage.

Warranty

EMKO Elektronik warrants that the equipment delivered is free from defects in material and workmanship. This warranty is provided for a period of two years. The warranty period starts from the delivery date. This warranty is in force if duty and responsibilities which are determined in warranty document and instruction manual performs by the customer completely.

Maintenance

Repairs should only be performed by trained and specialized personnel. Cut power to the device before accessing internal parts.
Do not clean the case with hydrocarbon-based solvents (Petrol, Trichlorethylene etc.). Use of these solvents can reduce the mechanical reliability of the device. Use a cloth dampened in ethyl alcohol or water to clean the external plastic case.

Other Information

Manufacturer Information:
Emko Elektronik Sanayi ve Ticaret A.Ş.
Demirtaş Organize Sanayi Bölgesi Karanfil Sk. No:6 16369 BURSA / TURKEY
Tel : +90 224 261 1900
Fax : +90 224 261 1912

Repair and maintenance service information:
Emko Elektronik Sanayi ve Ticaret A.Ş.
Demirtaş Organize Sanayi Bölgesi Karanfil Sk. No:6 16369 BURSA / TURKEY
Tel : +90 224 261 1900
Fax : +90 224 261 1912

Analog Input Type Dip Switch Positions

CH-1 input type selection

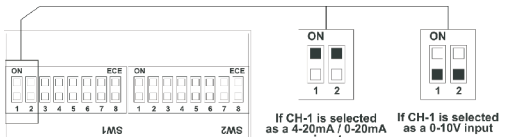

CH-2 input type selection

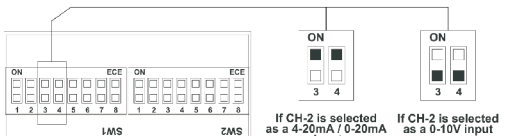

CH-3 input type selection

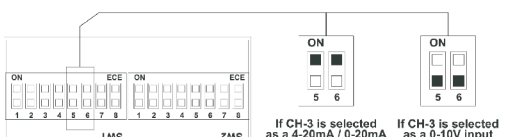

CH-4 input type selection

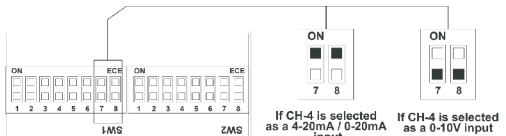

! To change the analog input type from voltage to current while the device is operating, first separate the voltage input then, change the input type to current and connect to current to the analog input.

Because of this reason a voltage input shouldn't be connected to the analog input of the device, while the device is in the current measurement mode, otherwise analog input can be damaged.

CH-5 input type selection

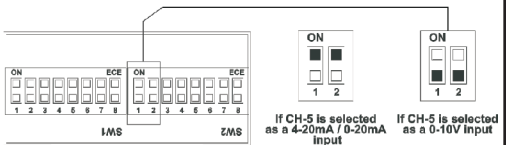

CH-6 input type selection

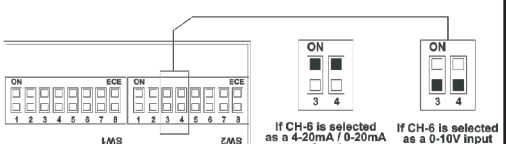

CH-7 input type selection

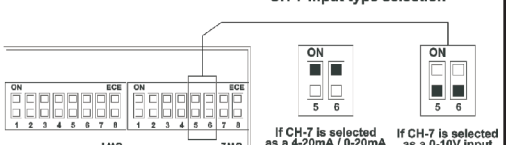

CH-8 input type selection

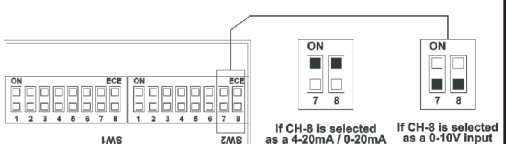

Ordering Information

CHANNEL8A-N (96 x 96 1/4 DIN)			
A	/	B	CDE
	/		

A Supply Voltage
1 100...240V ~ (-%15;+%10) 50/60Hz
2 24V ~ (-%15;+%10) 50/60Hz 24V = (-%15;+%10)

B Output Module Type
10 Relay outputs with 2 common
R for each NO contact 5A max. (5A@250V at resistive load)
for each Common contact 15A max (15A@250V at resistive load)

CDE Communication Type
200 RS-232 Modbus RTU
20U USB + RS-232 Modbus RTU
240 RS-485("500VAC isolation") + RS-232 Modbus RTU
2E0 Ethernet + RS-232 Modbus RTU
2EU Ethernet + USB + RS-232 Modbus RTU
24U USB + RS-485 + RS-232 Modbus RTU

All order information of CHANNEL8A-N are given in the table above. User may form appropriate device configuration from information and codes that at the table and convert it to the ordering codes.
Firstly, supply voltage then other specifications must be determined. Please fill the order code blanks according to your needs. Please contact us, if your needs are out of the standards.

EMKO Thank you very much for your preference to use Emko Elektronik products, please visit our www.emkoelektronik.com.tr Your Technology Partner web page to download user manual.