

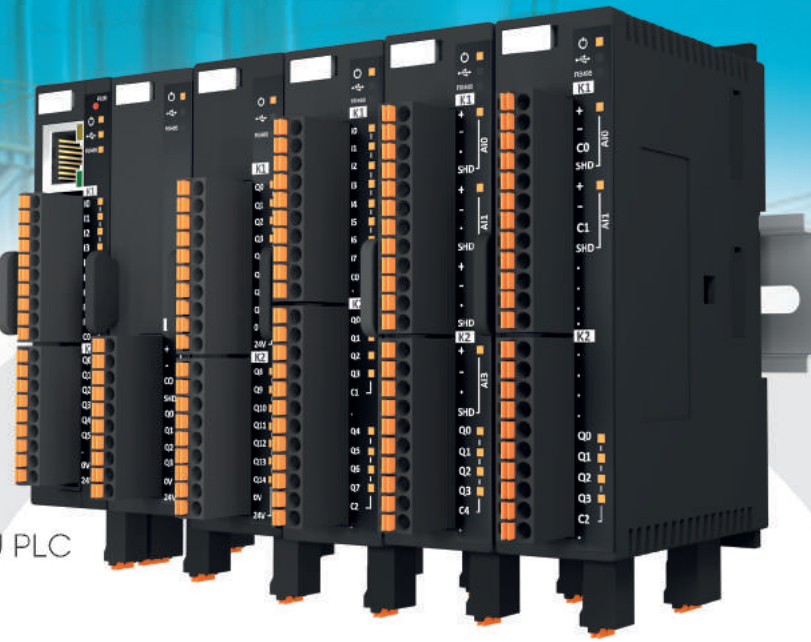

IPERTU

Industrial Process Control Platform



IPERTU PLC





IPERTU Platform

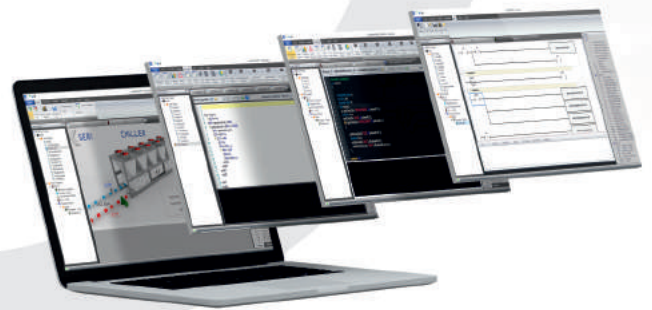

Proop Professional
Operator Panel

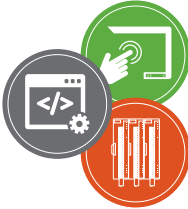

Ipertuide | Integrated
Development
Environment

	Page
	IPERTU (Industrial Process Control Platform) 02-03
	IPERTU.IDE Integrated Software Development Environment 04-05
	IPERTU Professional HMI Panel Series 06-07
	IPERTU PLC Modules Types 08-11
	IPERTU PLC Module Types 12-13
	IPERTU Plus PLC CPU Module 14
	IPERTU Analog Input (PID) Modules 15-21
	IPERTU Digital Input I/O Modules 22-26
	IPERTU Communication Modules 27
	IPERTU Power Supply Module 28
	IPERTU Relay Output Module 29
	IPERTU I/O Modules Comparison Table 30-32

What is the IPERTU ?

“EMKO Industrial Objects Platform” IPERTU was developed as a solution platform for industrial process control and monitoring. IPERTU Process control solution platform which consists of ;

- "Ipertu.ide" Integrated software development environment where Ladder, Macro, C language and HMI design programs are integrated,
- “IPERTU PLC” with PLC-CPU module and Analog/Digital Input I/O expansion modules,
- “Proop Professional HMI Panels” with Internal Analog/Digital Input-Output options.

All components of the IPERTU platform can work alone or integrated, depending on the process. IPERTU platform, which performs data collection, remote access, control and monitoring processes under the leadership of Industry 4.0, offers fast, effective and flexible solutions that make your work easier in process control with its constantly evolving structure.

Ipertu

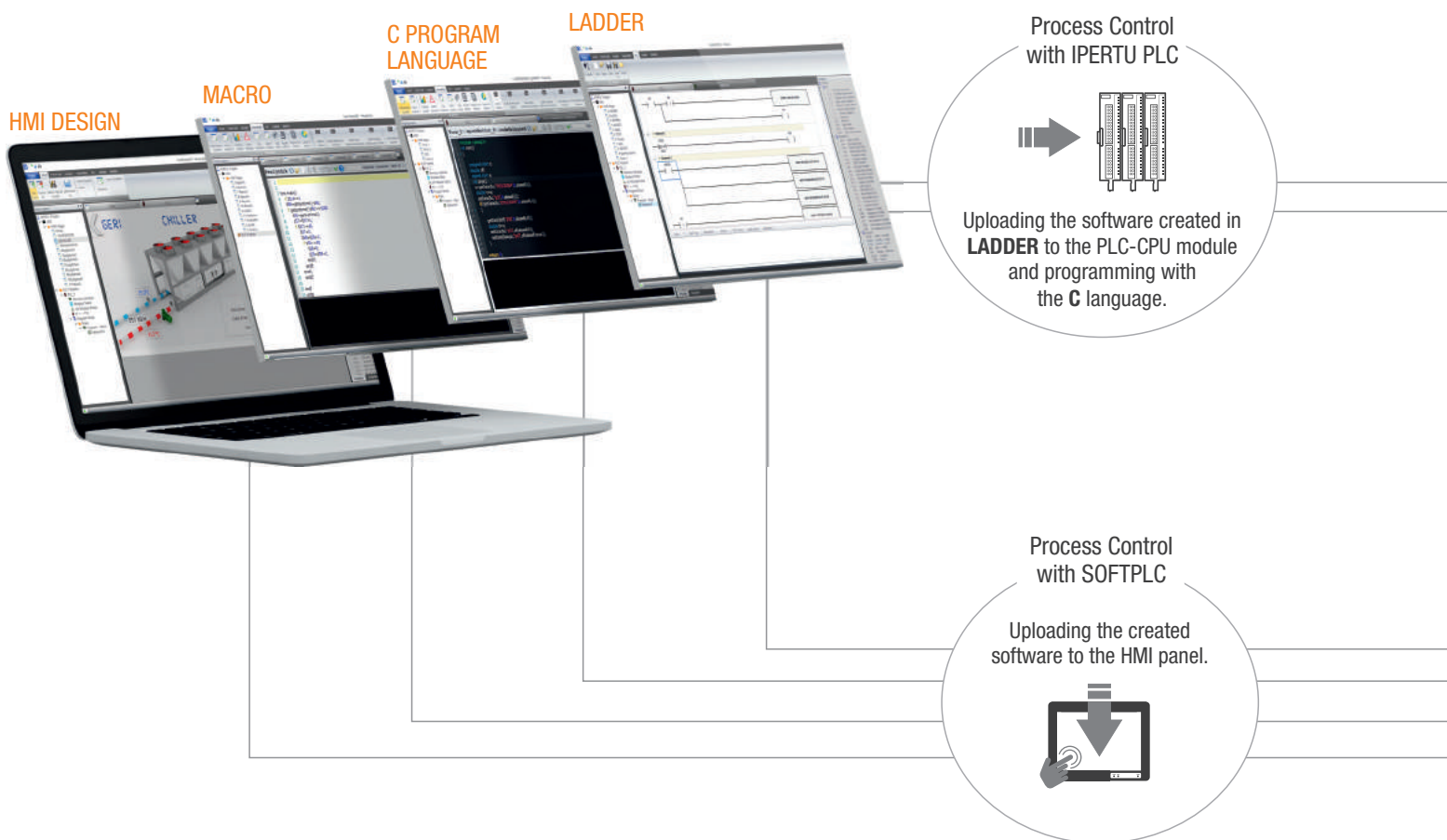

- **High visual** interface design with HMI Design,
- EASY application creation with **IPERTU Ladder**, performing many programming operations with blocks in ladder logic,
- **IPERTU Ladder, IPERTU Macro, C programming language, integrated work.**
- **SOFTPLC** running on HMI panel.

Process Control with Ipertu PLC

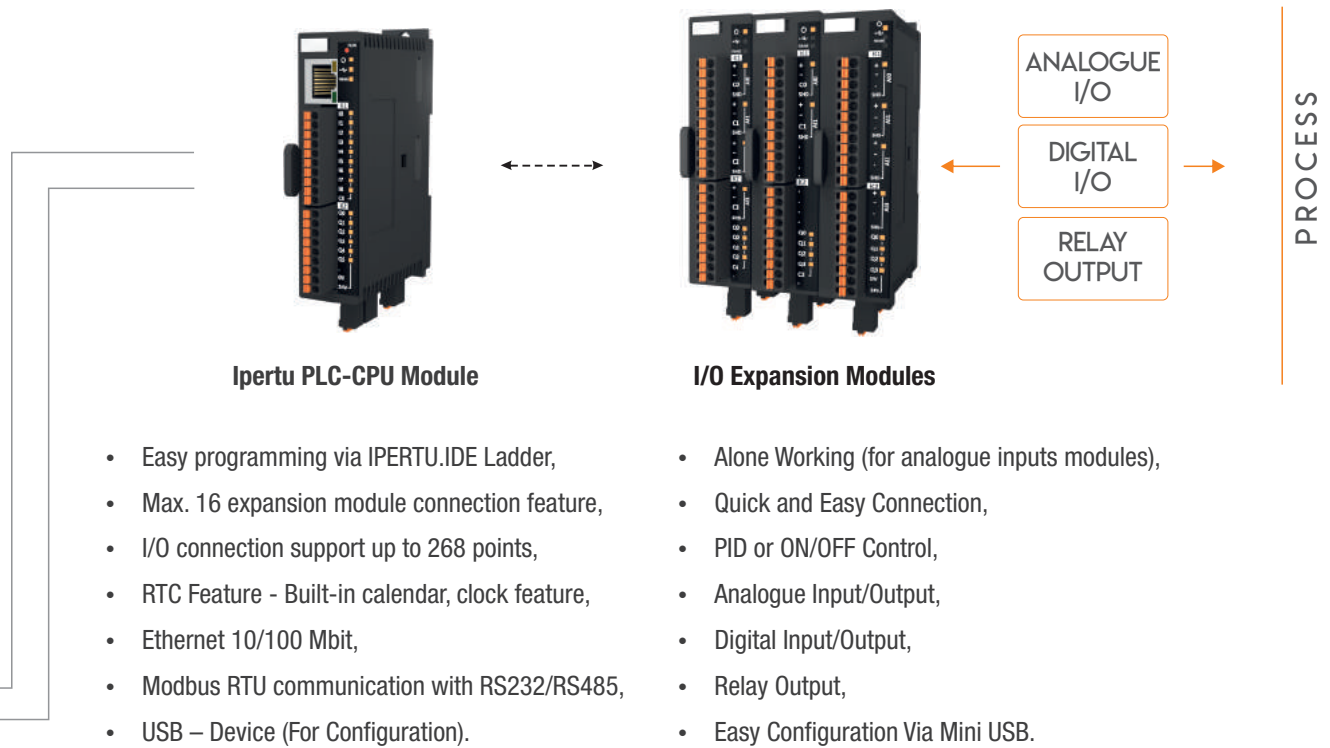
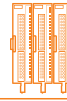

Process Control with SOFTPLC

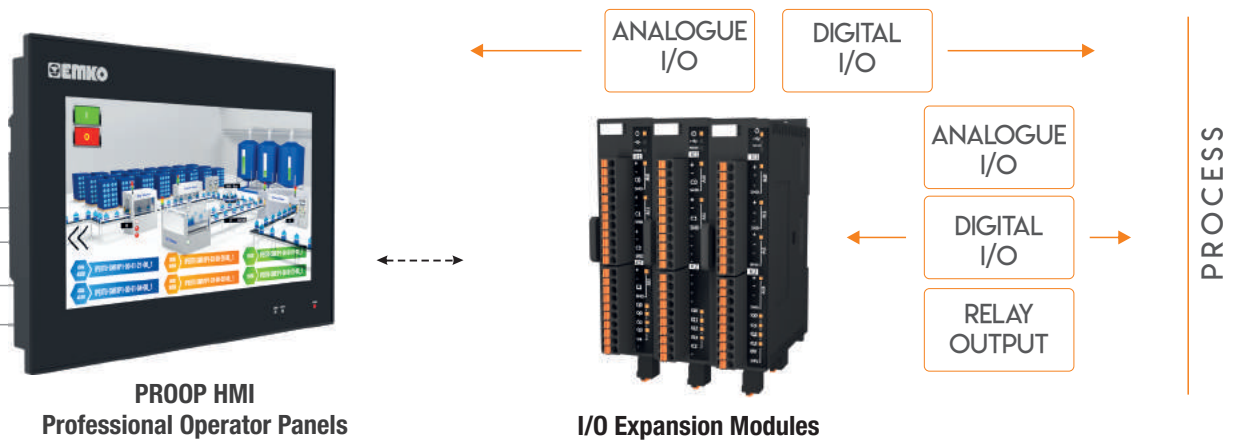

SOFTPLC

It is a software created by the user on the **Ipertu.ide** platform and running on the **Proop HMI**, converting the HMI panel into a PLC-CPU module. In this way, process control can be done with I/O expansion modules via Proop HMI without the need for a PLC-CPU module.

- Alone Working (for analogue inputs modules),
- Quick and Easy Connection,
- PID or ON/OFF Control,
- Analogue Input/Output,
- Digital Input/Output,
- Relay Output,
- Easy Configuration Via Mini USB.

Ipertu PLC programming, Ipertu HMI screen design and SOFTPLC creation via Ipertu.ide

Programming with integrated **Ladder (IEC61131-3)**, **Macro** and **C code** with **FAST** and **USER-FRIENDLY INTERFACE**.

Saving **TIME** while designing a high visual HMI screen with the Design feature with an easy menu structure.

Ipertu **ide** | Integrated Development Environment

Design

Macro

C Code

Ladder

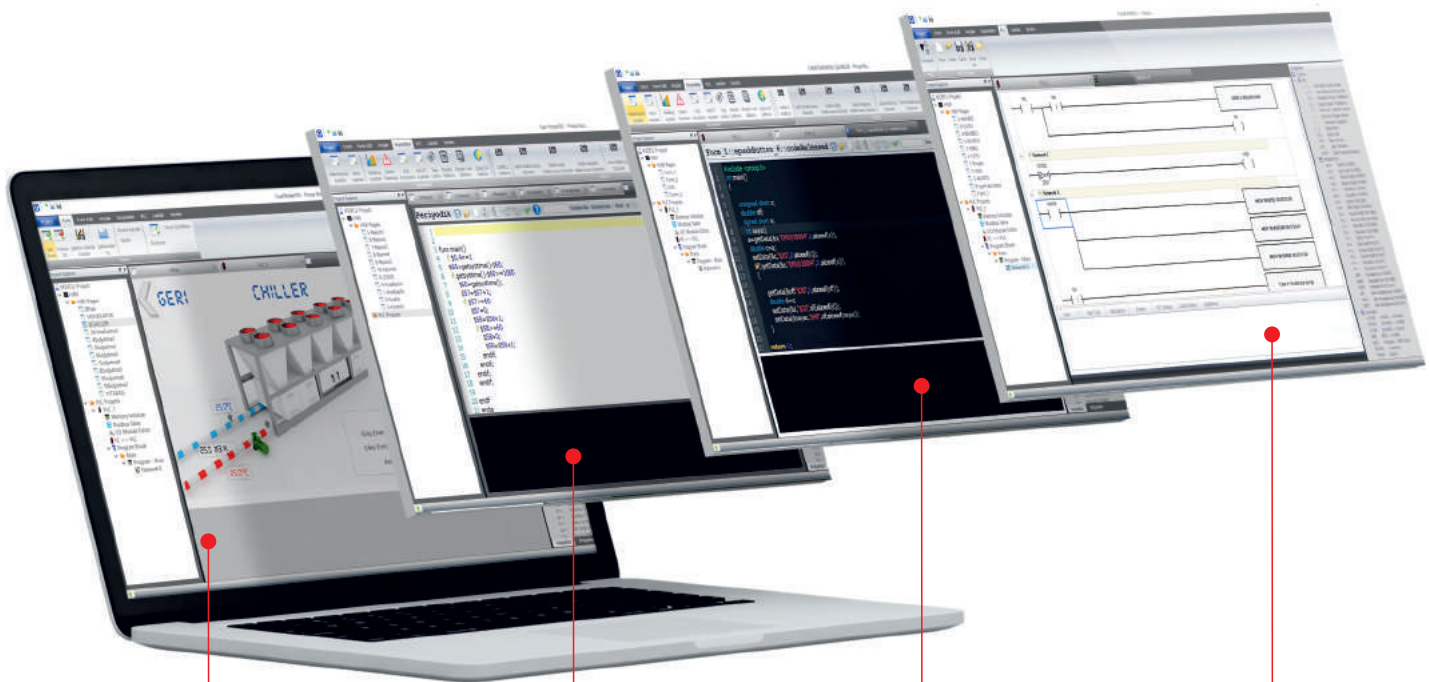

Design



Easy to use interface,
Quick accessible menus,
Wide font and image format support,
Rapid development projects.

Macro



Easier use of Proop HMI special functions thanks to ready-made Macro functions.

C Code



The power of the C programming language and the use of library functions for program development.

Ladder



EASY application creation IEC61131 standard. Performing many programming operations with the blocks in "Ladder Logic".

PLC-CPU and SOFTPLC programming with Ipertu.ide

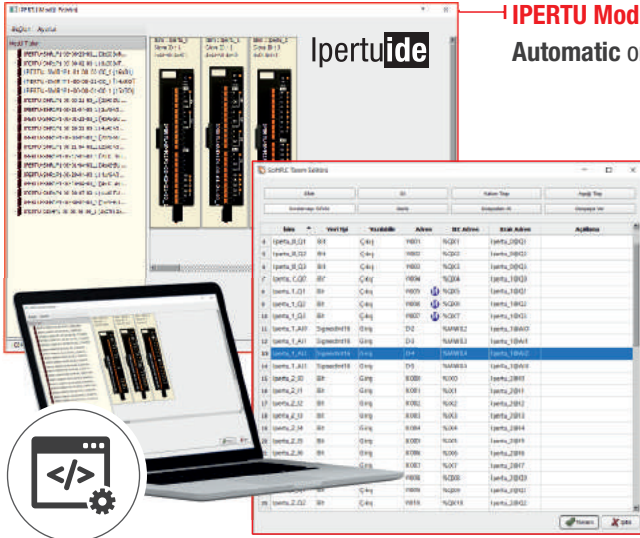

— IPERTU Module Editor;

Automatic or Manual identification of IPERTU expansion modules connected to Proop HMI.







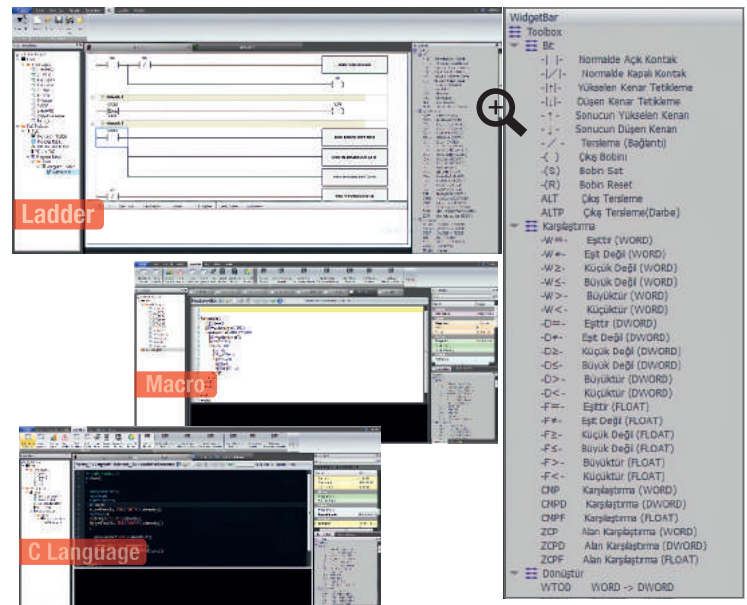



— Definition Editor ;

QUICK and EASY automatic import of "IPERTU Module Definitions" and creation of new Definitions via Definition Editor

FASTER, FLEXIBLE and **STRONG** programming with Ipertu.ide Integrated Software Development Environment, integrated **Ladder, Macro, C Code.**



IPERTU.IDE Rich Development Tools

				
USB Bridge	Online / offline Simulation	C Language	Online Debug	Offline Simulation
				
Ipertu.ide Macro	Ladder (LD)	SoftPLC	C Language	Ladder (LD)

Process control via SOFTPLC and Ipertu I/O Modules for Simple Applications



IPERTU HMI Panel + IPERTU I/O Module

Process control via PLC-CPU and Ipertu I/O Modules for Complex Applications

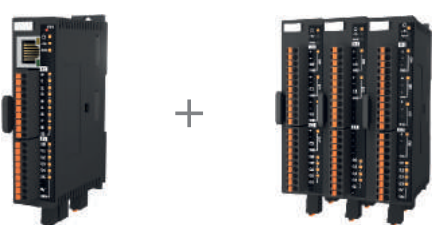

IPERTU PLC-CPU Module + IPERTU I/O Module



- ARM Cortex-A Series
- 8GB eMMC
- 512 MB DDR3 SDRAM
- 50000 hours Backlight Life
- Datalogger
- Alarm Recording

Proop Eco Series



- ModBus RS-232
- ModBus RS-485
- DEVICE
- HOST

Proop Lite Series



- ModBus RS-232
- ModBus RS-485
- DEVICE
- HOST
- ModBus RS-232
- ETHERNET

Proop Control Series



- 5X Digital Input
- 4X Digital Input
- ModBus RS-232
- ModBus RS-485
- DEVICE
- HOST
- ModBus RS-232
- ETHERNET
- ETHERNET

Proop Process Series



- 2X 4...20mA Analogue Input
- 2X 4...20mA Analogue Input
- 5X Digital Input
- 4X Digital Input
- ModBus RS-232
- ModBus RS-485
- DEVICE
- HOST
- ModBus RS-232
- ETHERNET
- ETHERNET



Interface and Process Connection Options for Proop HMI

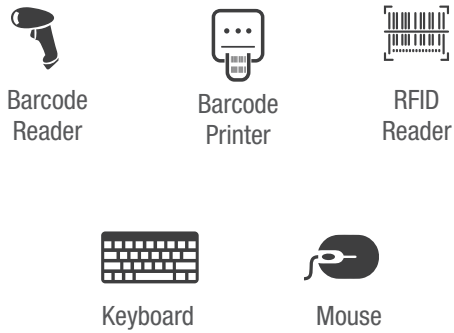
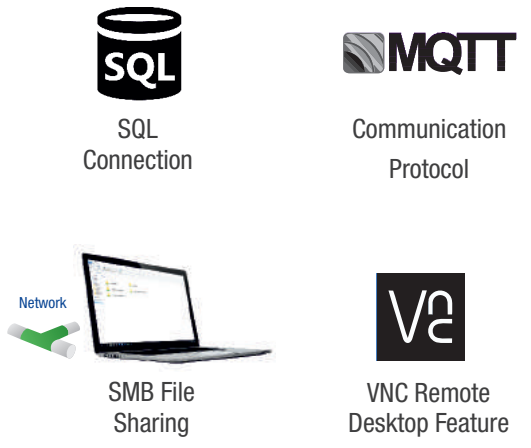

Process Control with PLC



Master Slave Slave
* Mak.16 SLAVE module connection

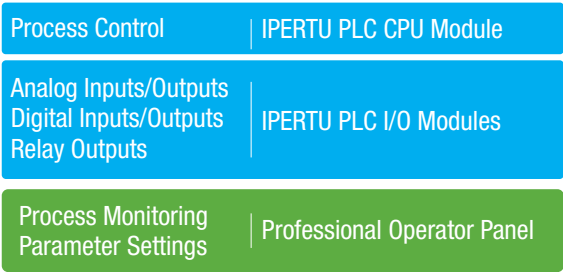

Process Control with SOFT PLC



Master Slave Slave
* Mak.16 SLAVE module connection

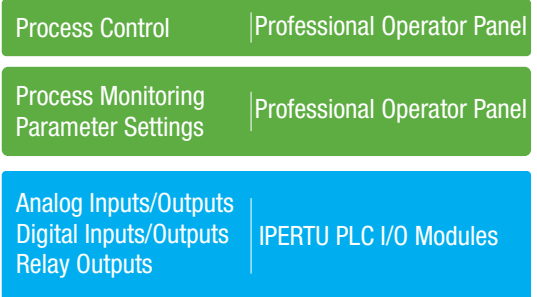

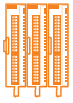

IPERTU PLC Module Types and Features

Ipertu PLC-CPU module, I/O expansion modules (Analog Input/Output Control modules, Digital Input/Output modules), Communication modules;

IPERTU Slim PLC-CPU Module

Slim PLC CPU Module with Digital Input/Transistor Output

- PLC online debug feature,
- Configurable via mini USB 2.0 connection,
- Modbus RTU communication with RS485 or RS232,
- Ethernet 10/100 Mbit.

- Easy programming via IPERTU.IDE Ladder, Transactions;
- Special purpose function blocks: PID and position control,
- Standard PLC commands: Logic, mathematical, time and counting relays,
- Hardware specific function blocks: Communication, fast counter and pulse outputs.

Via WQC “Web Quick Connect” feature ; Easy access via internet connection from all around the world



Accessing and monitoring Ipertu PLC modules without the need for any program via Web Browser with IPERTU Scada feature.

9 Digital input (NPN/PNP)



Max. 16 expansion module connections. I/O connection support up to 268 points.

6 Transistor output (PNP).



Built-in calendar, clock feature.

3 Channel 200kHz dual-phase, encoder or fast counter input.



Data Log feature via USB

Maximum frequency 100kHz for 6 channels.



Easy Supply and Communication connection via special BUS structure.

“Pulse-Width-Modulation” feature



“Pulse-Train-Output” feature



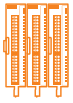

IPERTU PLC Module Types and Features

IPERTU Slim Plus PLC-CPU Module

CPU Speed / Command Times

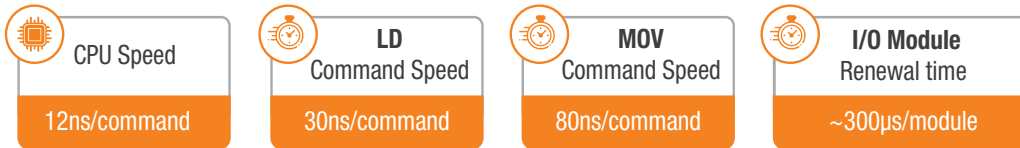

Memory



Application Memory



Volatile Memory Area Map

Address Name	Address Range	Address Type	Defination
X	0 - 127	BOOL	Logic Input Memory Area
Y	0 - 127	BOOL	Logic Output Memory Area
AI	0 - 31	WORD	Analog Input Memory Area
AO	0 - 31	WORD	Analog Output Memory Area
M	0 - 8191	BOOL	Bit Memory Area
D	0 - 8191	WORD	Data Memory Area
S	0 - 1023	BOOL	Status Bits
CV	0 - 199 200 - 255	WORD DWORD	Counter Memory Area
TV	0 - 255	WORD	Timer Memory Area
C	0 - 255	BOOL	Counter Bit Memory Area
T	0 - 255	BOOL	Timer Bit Memory Area

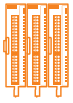

IPERTU PLC Module Types and Features

Analogue Input I/O Expansion Modules

I/O expansion modules with analog inputs can be configured with a Mini USB 2.0 connection. Depending on the process; It can work together with PLC-CPU module or Proop HMI. In addition, with its programmable parametric structure, it can work as a rail-mounted process control device without the need for any control unit.

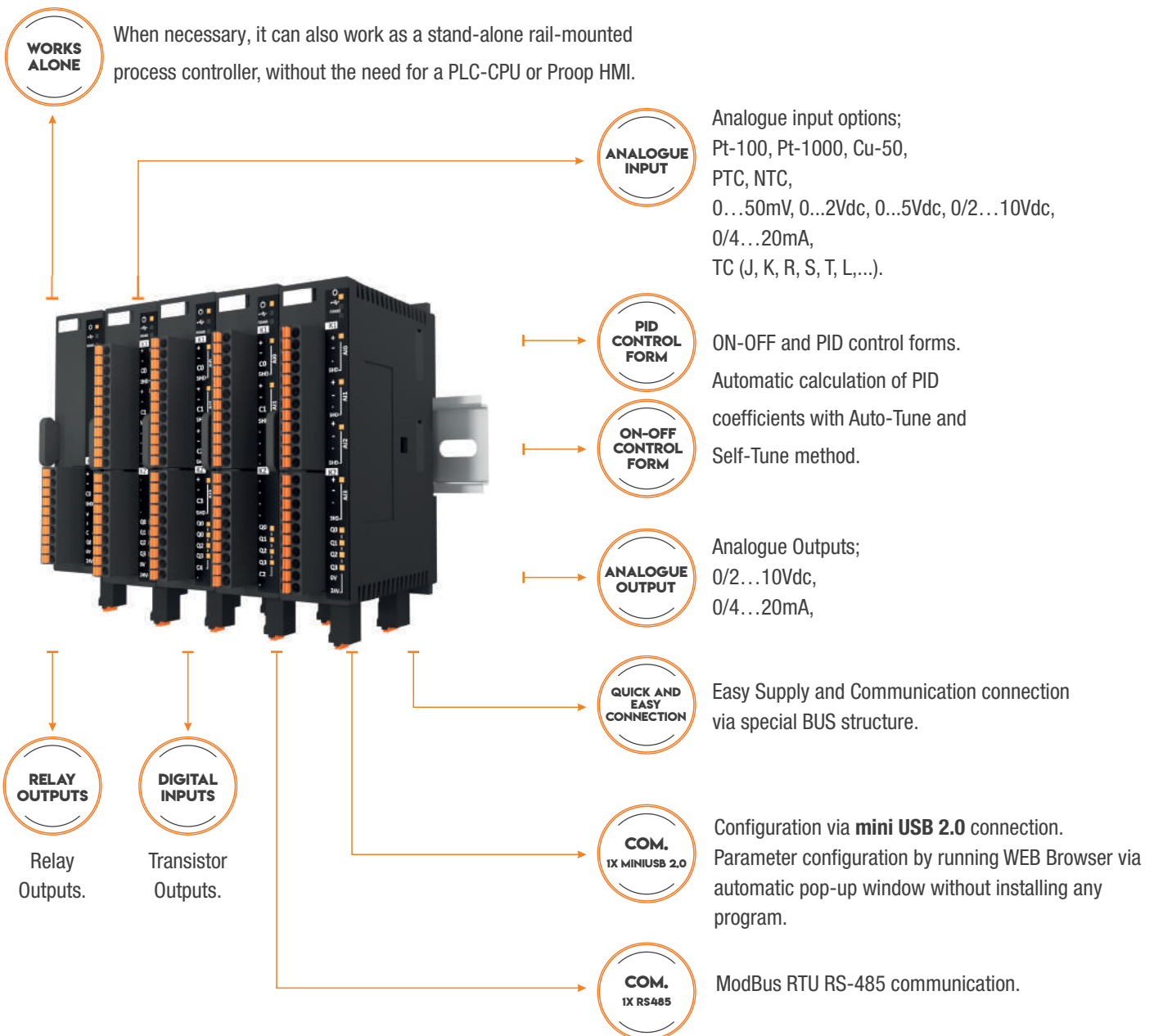

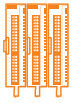

IPERTU PLC Module Types and Features

Digital Input I/O Expansion Modules

IPERTU PLC-I/O expansion modules with digital inputs are expansion modules with digital input, relay or transistor output. In cases where extra digital input, transistor or relay output is needed, it works as an expansion module with PLC-CPU module and Proop HMI panel.

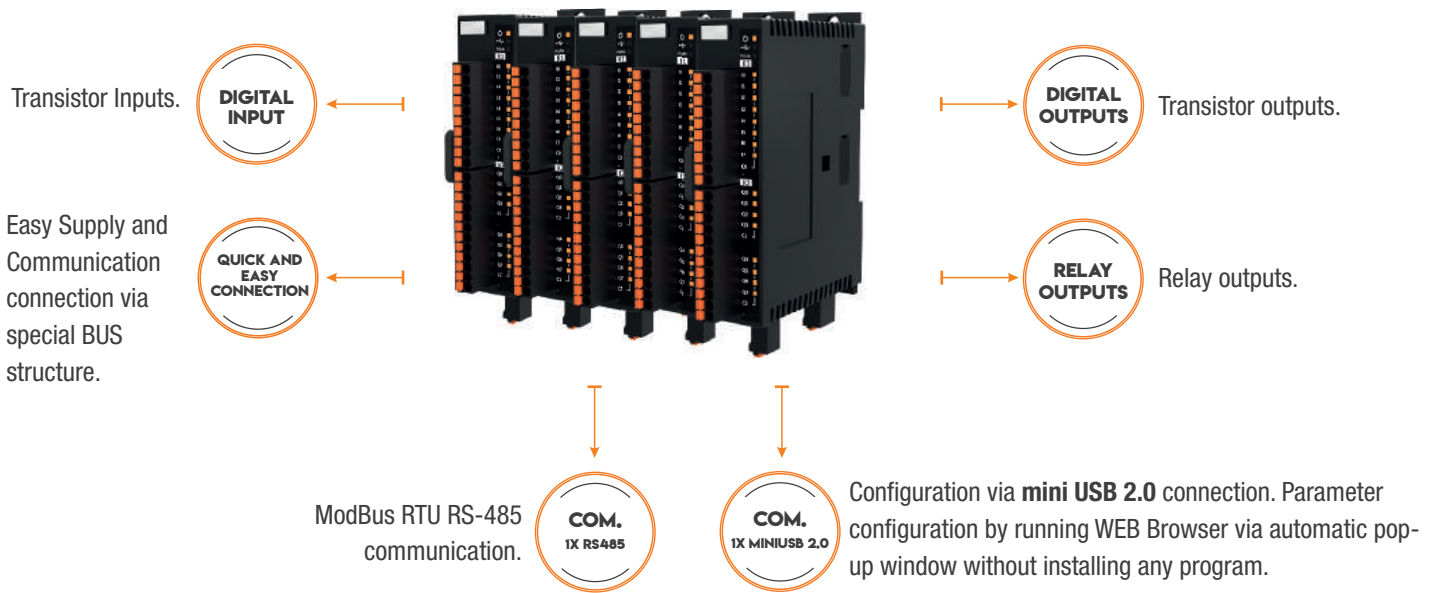

Communication Modules

IPERTU Communication Modules provide communication with PLC, HMI panel with 1x Ethernet input, 2x ModBus RS485 communication port.

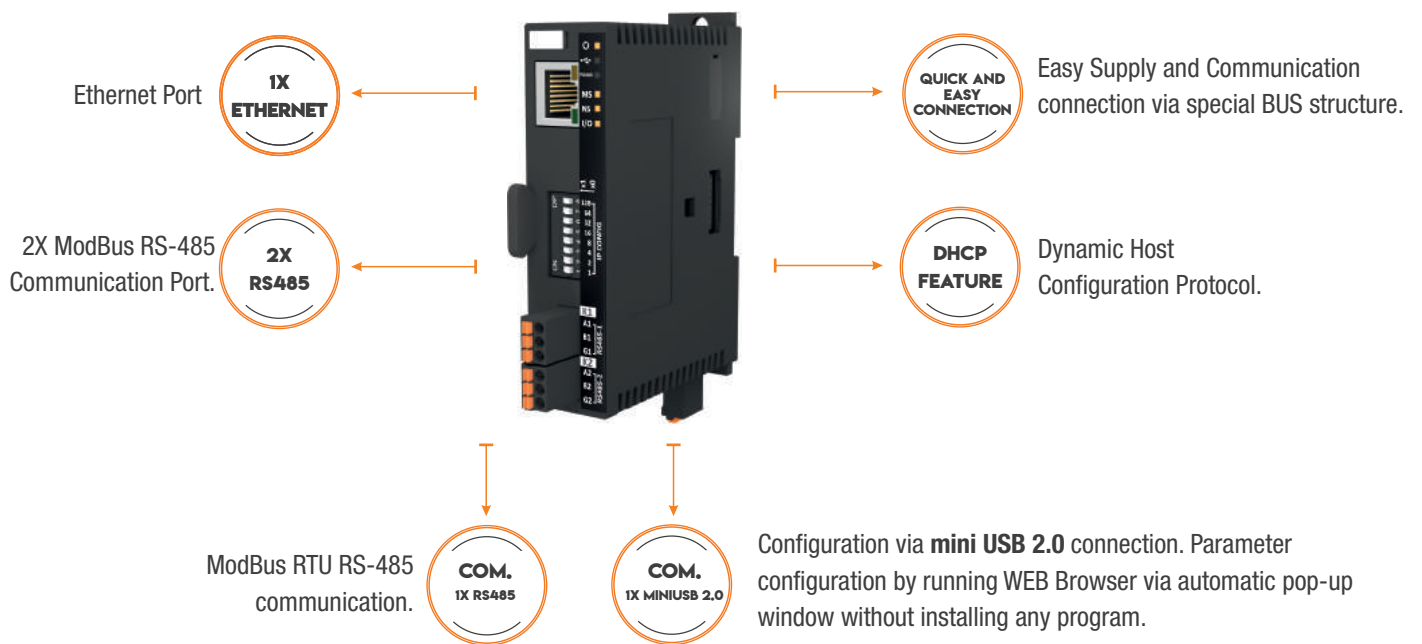

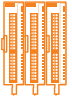

Quick and Easy Connection



Thanks to the special BUS structure between the modules, fast and easy connection without the need for communication and supply cables.

IPERTU CPU Module + I/O Module Connection

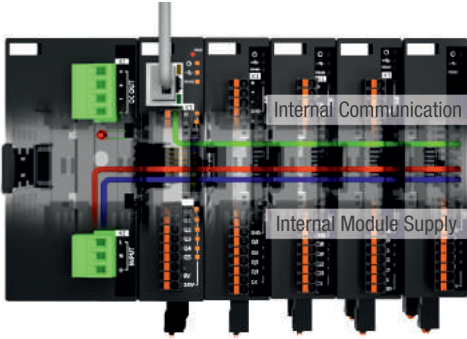

Supply Module CPU Module I/O Modules (Max. 16)

IPERTU Ethernet Module + I/O Module Connection

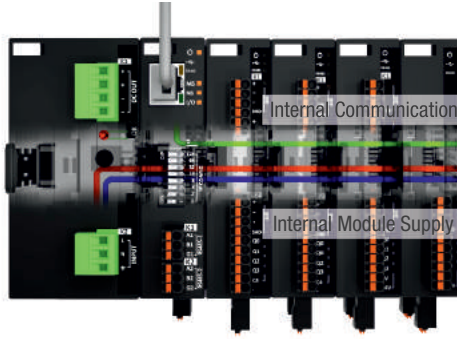

Supply Module Ethernet Gateway Modules I/O Modules (Max. 16)

IPERTU I/O Module Connection

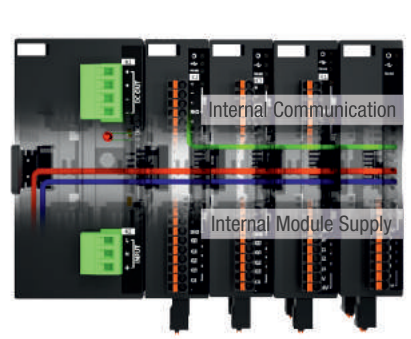

Supply Module I/O Modules (Max. 16)

Easy Configuration via USB



IPERTU modules are configured with Mini USB 2.0 connection. Without installing any program, parameter configuration and module software update can be done via the automatically opened window in WEB Browser. Uploading the LADDER code compiled from the PC to the PLC-CPU module or adjusting the Expansion modules depending on the process with its programmable parametric structure.



Mini USB 2.0
Connection



Quick Parameter Configuration via mini USB Connection;
Parameter configuration by running WEB Browser via automatic pop-up window without installing any program.

*** The software update is done with the latest version software downloaded from the WEB site.**

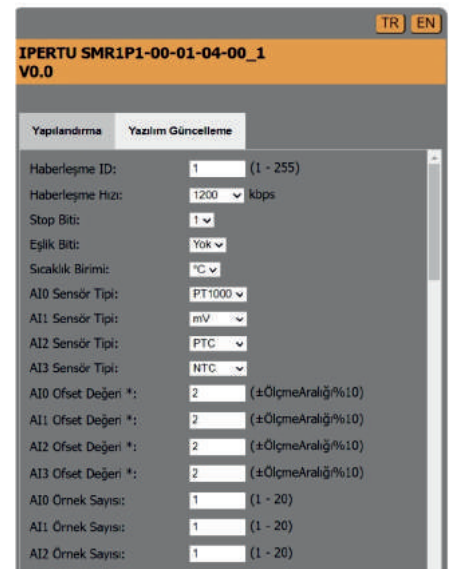

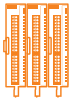

IPERTU PLC-CPU Modules

	Model	Inputs	(A,B,Z) Dual Phase Encoder or Fast Counter Input	Outputs	Output Speed
CPU Modules	Slim Basic	9x Digital Input (NPN-PNP)	3x 20kHz	6x Transistor Output (PNP)	20kHz
	Slim Plus		3x 200kHz		100kHz

IPERTU PLC - I/O Modules

	Inputs	Outputs	Communication/ Supply
Analogue Input (PID) Modules	2x Pt-100, Pt-1000, Cu-50, PTC, NTC, 4x 0...50mV	4x (NO) Relay 1,5A Transistor	Module Parameter Configuration via USB2.0 ModBus RS-485 Communication 24Vdc Supply OR PLC BUS * Parameter Configuration, Communication, Module Supply to be done via PLC BUS
	2x 0/2...10Vdc, 4x 0...2/5Vdc, 0/4...20mA	4x (NO) Relay 1,5A Transistor	
	2x TC (J, K, R, S, T, L, ...) 4x	4x Transistor	
	1x RTD, PTC, NTC, Vdc, mVdc, Adc, TC (J, K, R, S,T, L, ...),	4x Transistor	
	1x RTD, PTC, NTC, Vdc, mVdc, Adc, TC (J, K, R, S,T, L, ...),	1x Transistor and (0...10Vdc, 0...20mA)	
Digital Input Modules	8x Digital Input	8x (NO) Relay 1,5A	
	8x Digital Input	8x Transistor	
	16x Digital Input	-	
	-	14x (NO) Relay 1,5A	
	-	15x Transistor	

IPERTU Communication Modules

	Communication Properties
Ethernet Gateway Modules	2x RS485 + 1x miniUSB 2.0 + 1x Ethernet 1x miniUSB 2.0 + 1x Ethernet

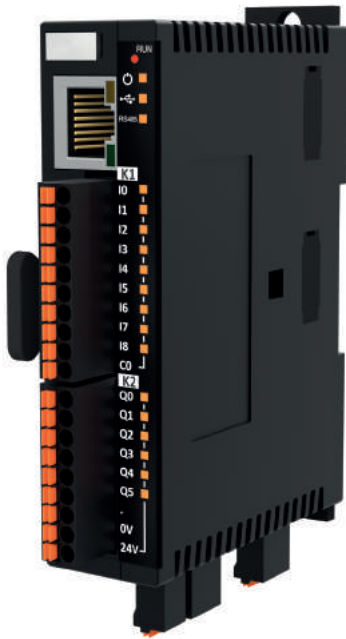
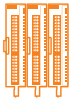

WQC WQC "Web Quick Connect" feature ; Easy access via internet connection from all around the world

IPERTU SCADA Accessing and monitoring Iperu PLC modules without the need for any program via Web Browser with IPERTU Scada feature.

CPU Speed 12ns/command	LD Command Speed 30ns/command	MOV Command Speed 80ns/command
Program Capacity 196kB	Data Memory 27kB	Retain Memory/Lifetime 4kB / 10 Year

(A,B,Z) Dual Phase Encoder or Fast Counter Input

Slim Plus PLC-CPU Module IPERTU-SPP3P1-30-00-51-00_1	3 piece 200Khz
Slim Basic PLC-CPU Module IPERTU-SPL3P1-02-00-03-00_1	3 piece 20Khz

Easy programming with IPERTU.IDE Ladder (LD) language,
9 Digital inputs (NPN / PNP),
6 Digital Outputs (PNP),
Modular connectivity (Max. 16 devices, 268 I/O ports),
Built-in calendar-clock (RTC),
Data logging via USB,
Ethernet 10/100 Mbit,
Modbus RTU communication with RS485 and RS232.

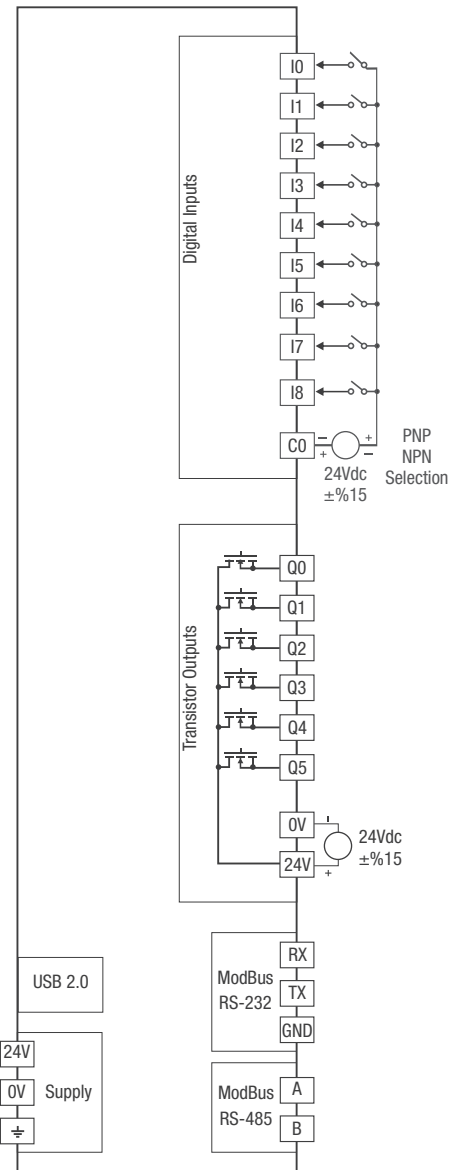

General Specifications

Supply	
Supply Voltage	24 VDC (±%20) (19,2 VDC - 28,8 VDC)
Power Consumption	2W
Communication Ports	
Communication Port	1x RS-232, 1x RS-485 Modbus RTU
Program Installation/Configuration	1x USB (Mini USB2.0)
Inputs	
Digital Inputs	9x Digital NPN /PNP inputs
Response Speed	2.5µs for 9 inputs
Max. Current	6 mA
Outputs	
Digital Outputs	6x PNP outputs
Reaction Time	5µsn
Digital Output Current	0.3 A (single channel), 1.8 A (total COM currents)
Environmental Conditions	
Operating / Storage Temperature	-10°C...+60°C / -20°C...+70°C
Mounting Type	Rail Mounting

Product Codes

IPERTU PLC CPU Modules	Module Types	Digital Inputs	(A,B,Z) Dual Phase Encoder or Fast Counter Input	Digital Input (100KHz)	Digital Output (20KHz)	ETH	USB	RS232	RS485
IPERTU-SPP3P1-30-00-51-00_1	Slim Plus	9x NPN/PNP	3 pcs 200Khz	6x Transistor	-	+	+	+	+
IPERTU-SPL3P1-02-00-03-00_1	Slim Basic	9x NPN/PNP	3 pcs 20Khz	-	6x Transistor	+	+	+	+

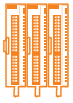

IPERTU Analog Input (PID) Modules

2x or 4x Analog Inputs (RTD,PTC,NTC,mVdc)
4x Relay Output, PID Module

WORKS ALONE



SMR1P1-00-01-21-00_1

SMR1P1-00-03-21-00_1

General Specifications

Supply	
Supply Voltage	24Vdc ($\pm\%20$) or PLCBUS
Power Consumption	1,5W
Communication Ports	
Communication Port	1x RS-485 or PLCBUS
Program Installation/Configuration	1x USB (Mini USB2.0) or PLCBUS
Inputs	
Analogue Inputs	2x or 4x (Pt-100, Pt-1000, PTC, NTC, 0...50mV)
ADC Resolution	15bit
Measuring Speed	Per Channel 160msn
Outputs	
Relay Outputs	4x (NO) Relay Output (1,5A)
Reaction time	10 msn
Environmental Conditions	
Operating / Storage Temperature	-10°C...+60°C / -20°C...+70°C
Mounting Type	Rail Mounting

Compatible with ModbusRTU (RS-485) Master devices,
2x Semi-Universal inputs (RTD,PTC,NTC,mVdc),
4x Semi-Universal inputs (RTD,PTC,NTC,mVdc),
4x NO 1.5A Relay output,
Programmable PID and ON-OFF control forms,
Automatic PID calculation with Self-Tune or Auto-Tune operations,
Mini USB-USB2.0 (Software Download/Configuration),
Modular Connection (Maximum 16 devices),
Snap-in type terminal, 25mm wide.

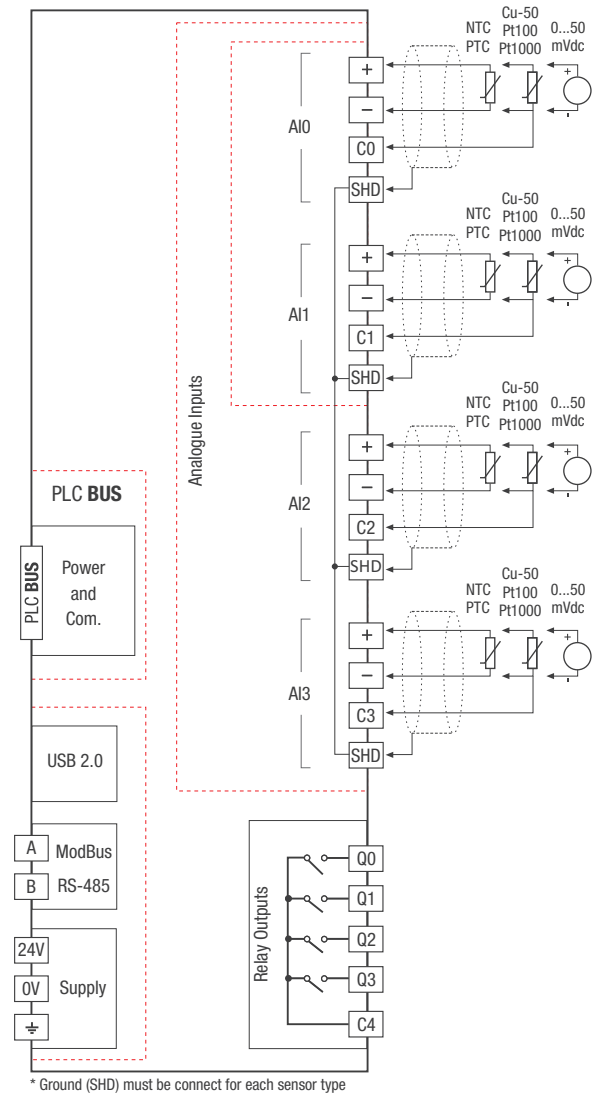

Product Codes

IPERTU Expansion Module	Digital Input	Analogue Input	Digital Output	Relay Output	Analogue Output	Communication Port	PID - ON/OFF Control Form
IPERTU-SMR1P1-00-03-21-00_1	-	2x	-	4x	-	1x RS485 + 1x miniUSB 2.0	+
IPERTU-SMR1P1-00-01-21-00_1	-	4x	-	4x	-	1x RS485 + 1x miniUSB 2.0	+
IPERTU-SMR0P0-00-03-21-00_1	-	2x	-	4x	-	PLC BUS	+
IPERTU-SMR0P0-00-01-21-00_1	-	4x	-	4x	-	PLC BUS	+

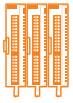

IPERTU Analog Input (PID) Modules

2x or 4x Analog Inputs (RTD,PTC,NTC,mVdc)
4x Transistor Output, PID Module

WORKS ALONE



SMR1P1-00-01-04-00_1

SMR1P1-00-03-04-00_1

General Specifications

Supply	
Supply Voltage	24Vdc ($\pm\%20$) or PLCBUS
Power Consumption	1W
Communication Ports	
Communication Port	1x RS-485 or PLCBUS
Program Installation/Configuration	1x USB (Mini USB2.0) or PLCBUS
Inputs	
Analogue Inputs	2x or 4x (Pt-100, Pt-1000, PTC, NTC, 0...50mV)
ADC Resolution	15bit
Measuring Speed	Per Channel 160msn
Outputs	
Digital Outputs	4x Transistor (24Vdc@0,3A)
Reaction time	170 μ sn
Environmental Conditions	
Operating / Storage Temperature	-10°C...+60°C / -20°C...+70°C
Mounting Type	Rail Mounting

Compatible with ModbusRTU (RS-485) Master devices,
2x Semi-Universal inputs (RTD,PTC,NTC,mVdc),
4x Semi-Universal inputs (RTD,PTC,NTC,mVdc),
4x Transistor outputs,
Programmable PID and ON-OFF control forms,
Automatic PID calculation with Self-Tune or Auto-Tune operations,
Mini USB-USB2.0 (Software Download/Configuration),
Modular Connection (Maximum 16 devices),
Snap-in type terminal, 25mm wide.

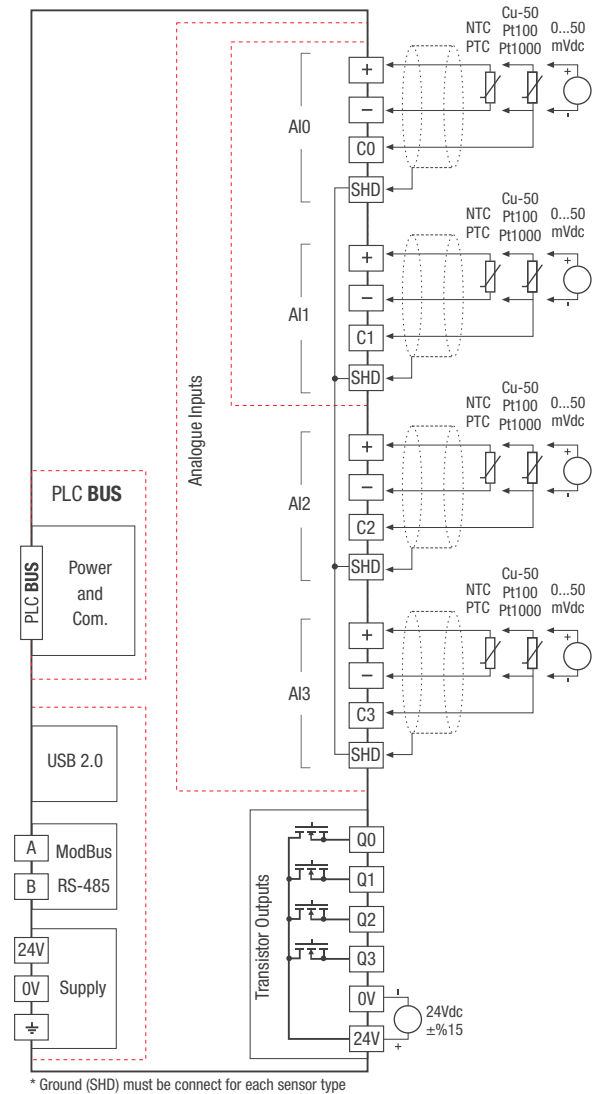

Product Codes

IPERTU Expansion Module	Digital Input	Analogue Input	Digital Output	Relay Output	Analogue Output	Communication Port	PID - ON/OFF Control Form
IPERTU-SMR1P1-00-03-04-00_1	-	2x	4x	-	-	1x RS485 + 1x miniUSB 2.0	+
IPERTU-SMR1P1-00-01-04-00_1	-	4x	4x	-	-	1x RS485 + 1x miniUSB 2.0	+
IPERTU-SMROPO-00-03-04-00_1	-	2x	4x	-	-	PLC BUS	+
IPERTU-SMROPO-00-01-04-00_1	-	4x	4x	-	-	PLC BUS	+

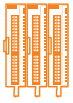

IPERTU Analog Input (PID) Modules

2x or 4x Analog Inputs (Vdc,mA)
4x Relay Outputs, PID Module



SMR1P1-00-20-21-00_1

SMR1P1-00-21-21-00_1

General Specifications

Supply	
Supply Voltage	24Vdc ($\pm\%20$) or PLCBUS
Power Consumption	1,5W
Communication Ports	
Communication Port	1x RS-485 or PLCBUS
Program Installation/Configuration	1x USB (Mini USB2.0) or PLCBUS
Inputs	
Analogue Inputs	2x or 4x (0/2...10Vdc, 0/4...20mA)
ADC Resolution	15bit
Measuring Speed	Per Channel 160msn
Outputs	
Relay Outputs	4x (NO) Relay Output (1,5A)
Reaction time	10 msn
Environmental Conditions	
Operating / Storage Temperature	-10°C...+60°C / -20°C...+70°C
Mounting Type	Rail Mounting

Compatible with Modbus RTU (RS-485) Master devices,
2x Analog input (Vdc,mA),
4x Analog inputs (Vdc,mA),
4x NO 1.5A Relay output,
Programmable PID and ON-OFF control forms,
Automatic PID calculation with Self-Tune or Auto-Tune operations,
Mini USB-USB2.0 (Software Download/Configuration),
Modular Connection (Maximum 16 devices),
Snap-in type terminal, 25mm wide.

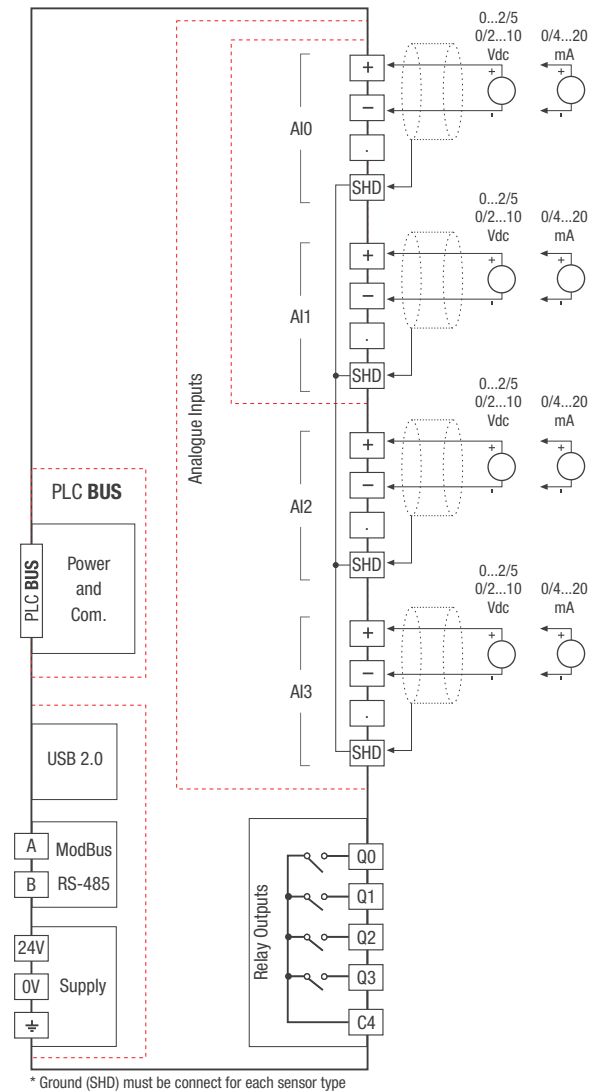

Product Codes

IPERTU Expansion Module	Digital Input	Analogue Input	Digital Output	Relay Output	Analogue Output	Communication Port	PID - ON/OFF Control Form
IPERTU-SMR1P1-00-21-21-00_1	-	2x	-	4x	-	1x RS485 + 1x miniUSB 2.0	+
IPERTU-SMR1P1-00-20-21-00_1	-	4x	-	4x	-	1x RS485 + 1x miniUSB 2.0	+
IPERTU-SMR0P0-00-21-21-00_1	-	2x	-	4x	-	PLC BUS	+
IPERTU-SMR0P0-00-20-21-00_1	-	4x	-	4x	-	PLC BUS	+

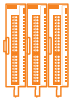

IPERTU Analog Input (PID) Modules

2x or 4x Analog Inputs (Vdc,mA)
4x Transistor Output, PID Module



SMR1P1-00-20-04-00_1

SMR1P1-00-21-04-00_1

General Specifications

Supply	
Supply Voltage	24Vdc ($\pm\%20$) or PLCBUS
Power Consumption	1W
Communication Ports	
Communication Port	1x RS-485 or PLCBUS
Program Installation/Configuration	1x USB (Mini USB2.0) or PLCBUS
Inputs	
Analogue Inputs	2x or 4x (0/2...10Vdc, 0/4...20mA)
ADC Resolution	15bit
Measuring Speed	Per Channel 160msn
Outputs	
Digital Outputs	4x Transistor (24Vdc@0,3A)
Reaction time	170 μ sn
Environmental Conditions	
Operating / Storage Temperature	-10°C...+60°C / -20°C...+70°C
Mounting Type	Rail Mounting

Compatible with Modbus RTU (RS-485) Master devices,
2x Analog input (Vdc,mA),
4x Analog inputs (Vdc,mA),
4x Transistor output,
Programmable PID and ON-OFF control forms,
Automatic PID calculation with Self-Tune or Auto-Tune operations,
Mini USB-USB2.0 (Software Download/Configuration),
Modular Connection (Maximum 16 devices),
Snap-in type terminal, 25mm wide.

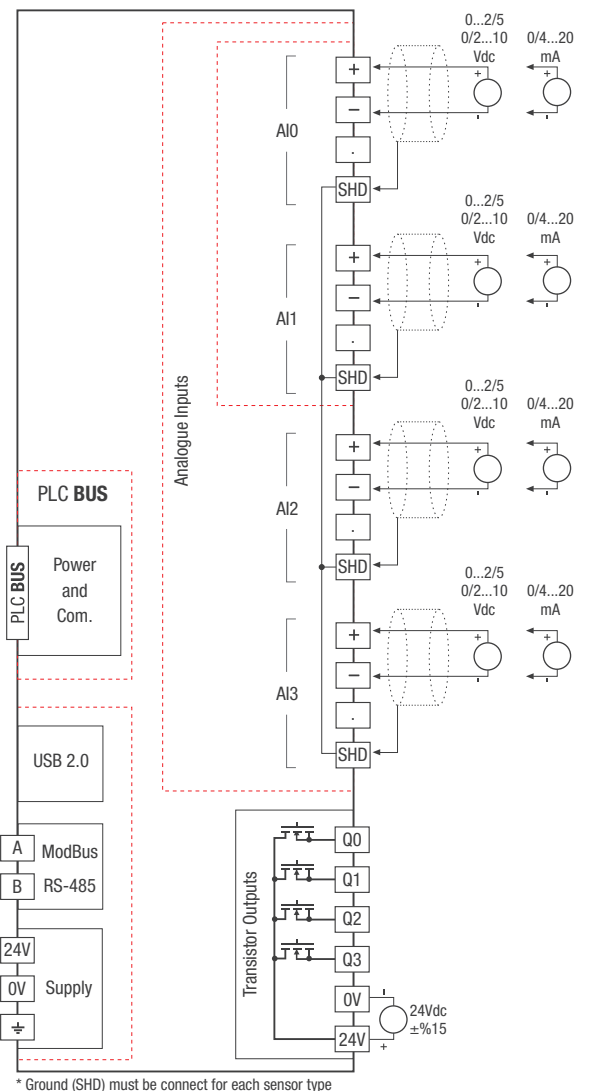

Product Codes

IPERTU Expansion Module	Digital Input	Analogue Input	Digital Output	Relay Output	Analogue Output	Communication Port	PID - ON/OFF Control Form
IPERTU-SMR1P1-00-21-04-00_1	-	2x	4x	-	-	1x RS485 + 1x miniUSB 2.0	+
IPERTU-SMR1P1-00-20-04-00_1	-	4x	4x	-	-	1x RS485 + 1x miniUSB 2.0	+
IPERTU-SMROPO-00-21-04-00_1	-	2x	4x	-	-	PLC BUS	+
IPERTU-SMROPO-00-20-04-00_1	-	4x	4x	-	-	PLC BUS	+

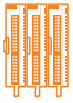

IPERTU TC Input (PID) Modules

2x or 4x Analog Inputs (J, K, R, S, T, L, ...)
4x Transistor Output, PID Module



SMR1P1-00-10-04-00_1

SMR1P1-00-12-04-00_1

Compatible with Modbus RTU (RS-485) Master devices,
2x Thermocouple input TC (J, K, R, S, T, L, ...),
4x Thermocouple input TC (J, K, R, S, T, L, ...),
4x Transistor output,
Programmable PID and ON-OFF control forms,
Automatic PID calculation with Self-Tune or Auto-Tune operations,
Mini USB-USB2.0 (Software Download/Configuration),
Modular Connection (Maximum 16 devices),
Snap-in type terminal, 25mm wide.

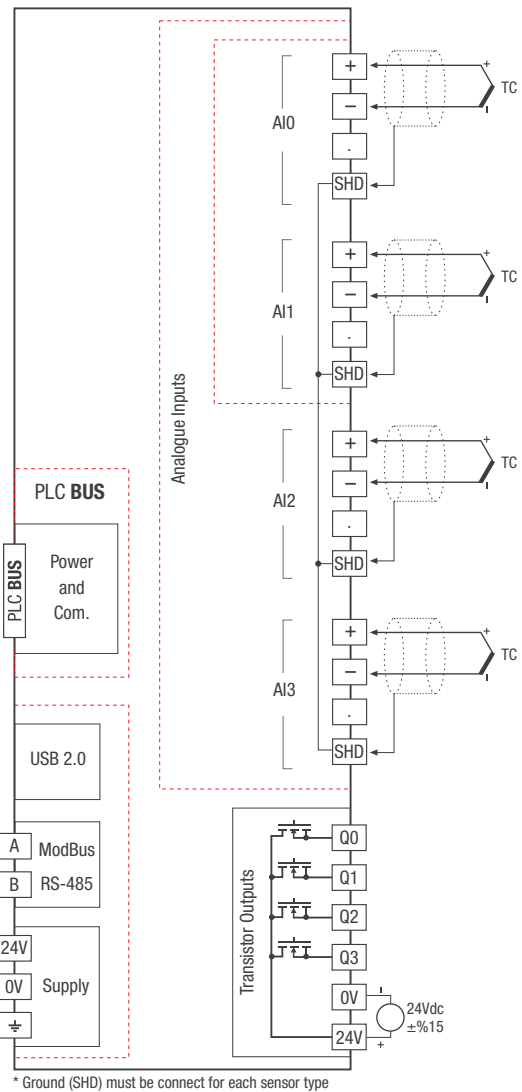

General Specifications

Supply	
Supply Voltage	24Vdc (±%20) or PLCBUS
Power Consumption	1,5W
Communication Ports	
Communication Port	1x RS-485 or PLCBUS
Program Installation/Configuration	1x USB (Mini USB2.0) or PLCBUS
Inputs	
Analogue Inputs	2x or 4x TC (J, K, R, S, T, L, ...)
ADC Resolution	15bit
Measuring Speed	Per Channel 160msn
Outputs	
Digital Outputs	4x Transistor (24Vdc@0,3A)
Reaction time	170 µsn
Environmental Conditions	
Operating / Storage Temperature	-10°C...+60°C / -20°C...+70°C
Mounting Type	Rail Mounting

Product Codes

IPERTU Expansion Module	Digital Input	Analogue Input	Digital Output	Relay Output	Analogue Output	Communication Port	PID - ON/OFF Control Form
IPERTU-SMR1P1-00-12-04-00_1	-	2x TC	4x	-	-	1x RS485 + 1x miniUSB 2.0	+
IPERTU-SMR1P1-00-10-04-00_1	-	4x TC	4x	-	-	1x RS485 + 1x miniUSB 2.0	+
IPERTU-SMR0P0-00-12-04-00_1	-	2x TC	4x	-	-	PLC BUS	+
IPERTU-SMR0P0-00-10-04-00_1	-	4x TC	4x	-	-	PLC BUS	+

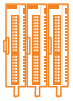

SMR1P1-00-30-04-00_1

Compatible with Modbus RTU (RS-485) Master devices,
1x Universal Analog Input (RTD,PTC,NTC, Vdc,mVdc,Adc,TC),
4x Transistor Digital Output (Active High),
Programmable PID and ON-OFF control forms,
Automatic PID calculation with Self-Tune or Auto-Tune operations,
Mini USB-USB2.0 (Software Download/Configuration),
Modular Connection (Maximum 16 devices),
Snap-in type terminal, 25mm wide.

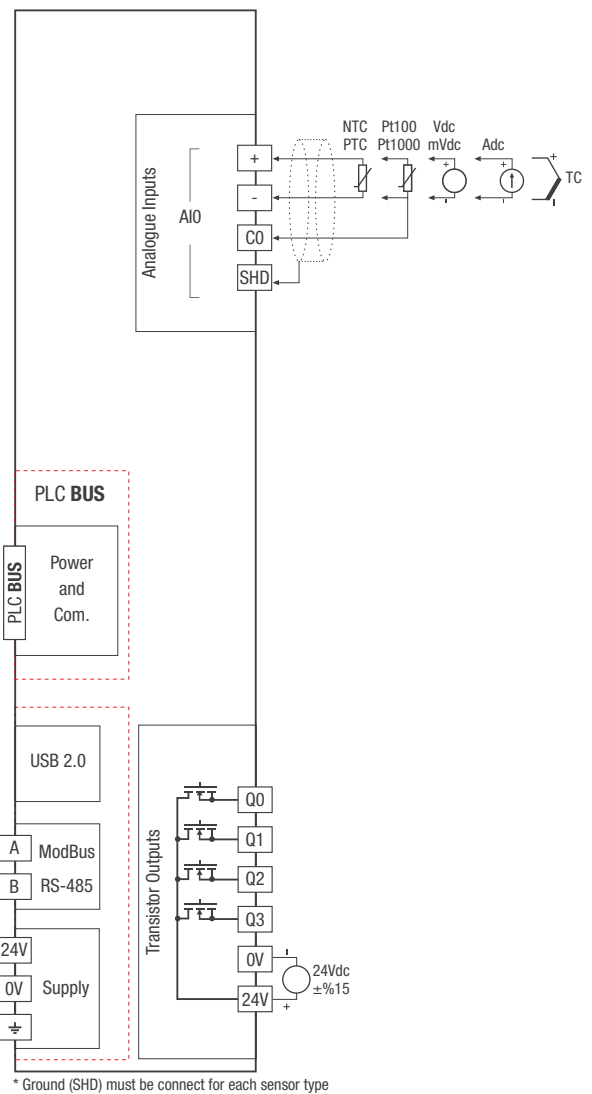

General Specifications

Supply	
Supply Voltage	24Vdc (±%20) or PLCBUS
Power Consumption	1,5W
Communication Ports	
Communication Port	1x RS-485 or PLCBUS
Program Installation/Configuration	1x USB (Mini USB2.0) or PLCBUS
Inputs	
Analogue Inputs	1x Universal analogue input
ADC Resolution	15 bit
Measuring Speed	Per Channel 160msn
Outputs	
Digital Outputs	4x Transistor (24Vdc@0,3A)
Reaction time	170 µsn
Environmental Conditions	
Operating / Storage Temperature	-10°C...+60°C / -20°C...+70°C
Mounting Type	Rail Mounting

Product Codes

IPERTU Expansion Module	Digital Input	Analogue Input	Digital Output	Relay Output	Analogue Output	Communication Port	PID - ON/OFF Control Form
IPERTU-SMR1P1-00-30-04-00_1	-	1x Universal Input	4x	-	-	1x RS485 + 1x miniUSB 2.0	+
IPERTU-SMROPO-00-30-04-00_1	-	1x Universal Input	4x	-	-	PLC BUS	+

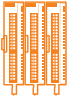

IPERTU Universal Analog Input / Output (PID) Modules

1x Universal Input (RTD,PTC,NTC, Vdc,mVdc,Adc,TC)1x Transistor + 1x Analog Output PID Module



SMR1P1-00-30-07-02_1

General Specifications

Supply	
Supply Voltage	24Vdc ($\pm\%20$) or PLCBUS
Power Consumption	1,5W
Communication Ports	
Communication Port	1x RS-485 or PLCBUS
Program Installation/Configuration	1x USB (Mini USB2.0) or PLCBUS
Inputs	
Analogue Inputs	1x Universal analogue input
ADC Resolution	15bit
Measuring Speed	Per Channel 160msn
Outputs	
Digital Outputs	1x Transistor (24Vdc@0,3A)
Reaction time	170 μ sn
Analogue Output	1x (0...10Vdc, 0...20mA)
Environmental Conditions	
Operating / Storage Temperature	-10°C...+60°C / -20°C...+70°C
Mounting Type	Rail Mounting

Modbus RTU (RS-485) haberleşmeli Master cihazlar ile uyumlu,
1x Üniversal analog giriş (RTD,PTC,NTC, Vdc,mVdc,Adc,TC),
1x Transistor çıkışı (Aktif Yüksek),
1x Analog çıkışı (0...10Vdc, 0...20mA),
Programlanabilir PID ve ON-OFF kontrol formları,
Self-Tune veya Auto-Tune işlemleri ile otomatik PID hesaplama,
Mini USB-USB2.0 (Yazılım Yükleme/Konfigürasyon),
Modüler Bağlantı (Maksimum 16 cihaz),
Snap-in tip terminal, 25mm genişlik.

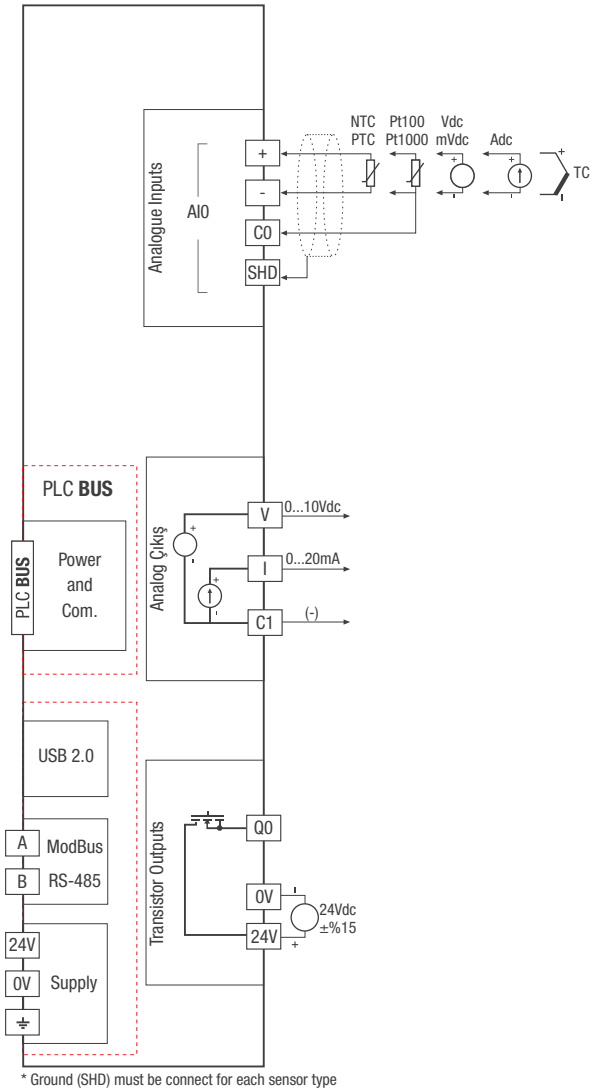

Product Codes

IPERTU Expansion Module	Digital Input	Analogue Input	Digital Output	Relay Output	Analogue Output	Communication Port	PID - ON/OFF Control Form
IPERTU-SMR1P1-00-30-07-02_1	-	1x Universal Input	1x	-	1x	1x RS485 + 1x miniUSB 2.0	+
IPERTU-SMR0P0-00-30-07-02_1	-	1x Universal Input	1x	-	1x	PLC BUS	+

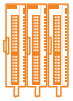

SMR1P1-03-00-20-00_1

Compatible with Modbus RTU (RS-485) Master devices,
8x Digital inputs,
8x Relay output (1.5A),
Mini USB-USB2.0 (Software Download/Configuration),
Modular Connection (Maximum 16 devices),
Snap-in type terminal,
25mm width.

General Specifications

Supply	
Supply Voltage	24Vdc ($\pm\%20$) or PLCBUS
Power Consumption	2W
Communication Ports	
Communication Port	1x RS-485 or PLCBUS
Program Installation/Configuration	1x USB (Mini USB2.0) or PLCBUS
Inputs	
Digital Inputs	8x Digital Input
Response Speed	20 μ sn
Maximum Current	6 mA
Outputs	
Relay Outputs	8x (NO) Relay Output (1,5A)
Reaction time	10msn
Environmental Conditions	
Operating / Storage Temperature	-10°C...+60°C / -20°C...+70°C
Mounting Type	Rail Mounting

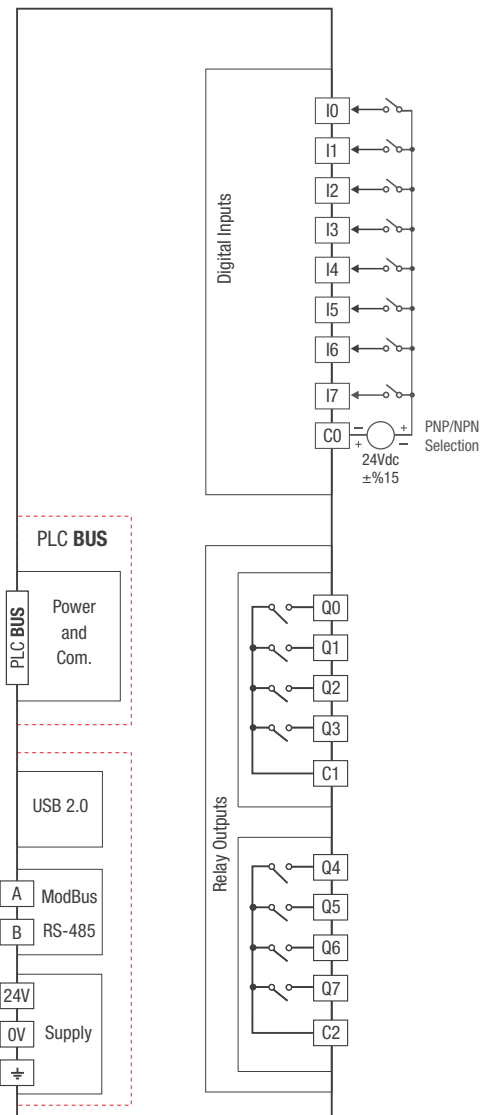

Product Codes

IPERTU Expansion Module	Digital Input	Analogue Input	Digital Output	Relay Output	Analogue Output	Communication Port	PID - ON/OFF Control Form
IPERTU-SMR1P1-03-00-20-00_1	8x	-	-	8x	-	1x RS485 + 1x miniUSB 2.0	-
IPERTU-SMROPO-03-00-20-00_1	8x	-	-	8x	-	PLC BUS	-

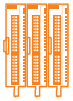

SMR1P1-03-00-02-00_1

Compatible with Modbus RTU (RS-485) Master devices,
8x Digital inputs,
8x Transistor output,
Mini USB-USB2.0 (Software Download/Configuration),
Modular Connection (Maximum 16 devices),
Snap-in type terminal,
25mm width.

General Specifications

Supply	
Supply Voltage	24Vdc (±%20) or PLCBUS
Power Consumption	1,5W
Communication Ports	
Communication Port	1x RS-485 or PLCBUS
Program Installation/Configuration	1x USB (Mini USB2.0) or PLCBUS
Inputs	
Digital Inputs	8x Digital Input
Response Speed	20µsn
Maximum Current	6 mA
Outputs	
Digital Outputs	8x (24Vdc@0,3A)
Reaction time	170 µsn
Environmental Conditions	
Operating / Storage Temperature	-10°C...+60°C / -20°C...+70°C
Mounting Type	Rail Mounting

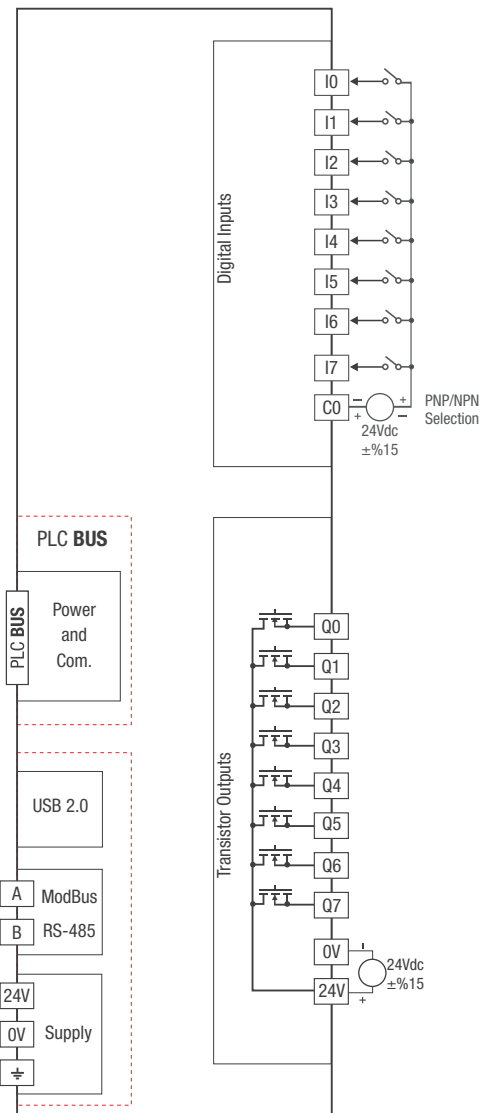

Product Codes

IPERTU Expansion Module	Digital Input	Analogue Input	Digital Output	Relay Output	Analogue Output	Communication Port	PID - ON/OFF Control Form
IPERTU-SMR1P1-03-00-02-00_1	8x	-	8x	-	-	1x RS485 + 1x miniUSB 2.0	-
IPERTU-SMROPO-03-00-02-00_1	8x	-	8x	-	-	PLC BUS	-

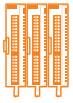

SMR1P1-01-00-00-01

Compatible with Modbus RTU (RS-485) Master devices,
 16x Digital inputs (PNP/NPN),
 Mini USB-USB2.0 (Software Download/Configuration),
 Modular Connection (Maximum 16 devices),
 Snap-in type terminal,
 25mm width.

General Specifications

Supply	
Supply Voltage	24Vdc ($\pm\%20$) or PLCBUS
Power Consumption	1W
Communication Ports	
Communication Port	1x RS-485 or PLCBUS
Program Installation/Configuration	1x USB (Mini USB2.0) or PLCBUS
Inputs	
Digital Inputs	16x Digital Inputs
Outputs	
Digital Outputs	-
Reaction time	-
Environmental Conditions	
Operating / Storage Temperature	-10°C...+60°C / -20°C...+70°C
Mounting Type	Rail Mounting

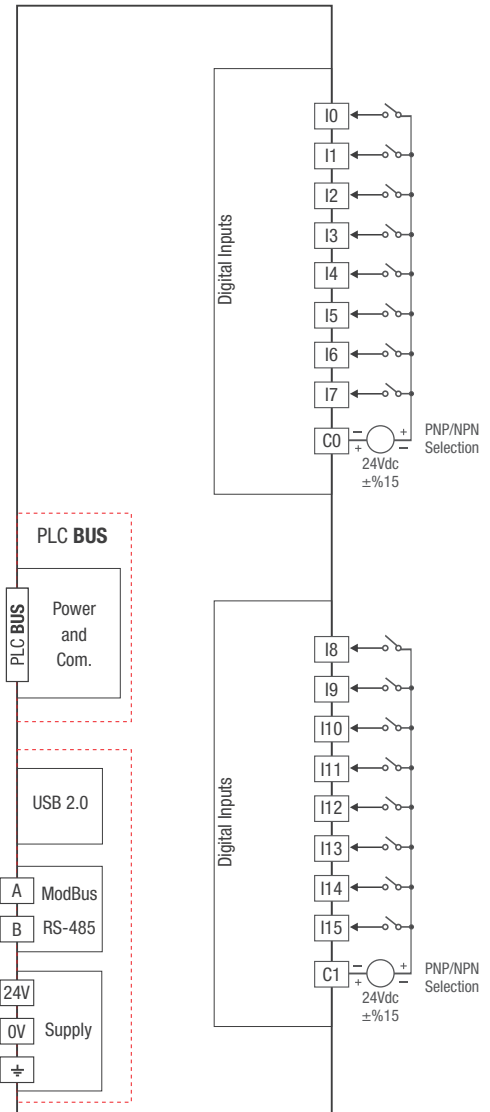

Product Codes

IPERTU Expansion Module	Digital Input	Analogue Input	Digital Output	Relay Output	Analogue Output	Communication Port	PID - ON/OFF Control Form
IPERTU-SMR1P1-01-00-00-01	16x	-	-	-	-	1x RS485 + 1x miniUSB 2.0	-
IPERTU-SMROPO-01-00-00-01	16x	-	-	-	-	PLC BUS	-

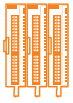

SMR1P1-00-00-01-00_1

Compatible with Modbus RTU (RS-485) Master devices,
 15x Transistor output,
 PNP/NPN output selection,
 Mini USB-USB2.0 (Software Download/Configuration),
 Modular Connection (Maximum 16 devices),
 Snap-in type terminal,
 25mm width.

General Specifications

Supply	
Supply Voltage	24Vdc ($\pm\%20$) or PLCBUS
Power Consumption	2W
Communication Ports	
Communication Port	1x RS-485 or PLCBUS
Program Installation/Configuration	1x USB (Mini USB2.0) or PLCBUS
Inputs	
Digital Inputs	-
Outputs	
Digital Outputs	15x (24Vdc@0,3A)
Reaction time	170 μ sn
Environmental Conditions	
Operating / Storage Temperature	-10°C...+60°C / -20°C...+70°C
Mounting Type	Rail Mounting

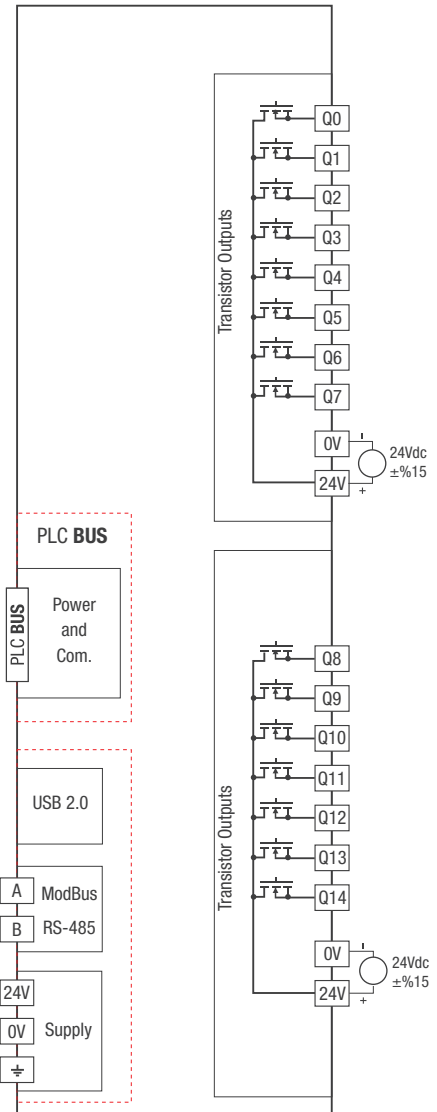

Product Codes

IPERTU Expansion Module	Digital Input	Analogue Input	Digital Output	Relay Output	Analogue Output	Communication Port	PID - ON/OFF Control Form
IPERTU-SMR1P1-00-00-01-00_1	-	-	15x	-	-	1x RS485 + 1x miniUSB 2.0	-
IPERTU-SMR0P0-00-00-01-00_1	-	-	15x	-	-	PLC BUS	-

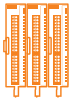

SMR1P1-00-00-22-00_1

Compatible with Modbus RTU (RS-485) Master devices,
 14x Relay (NO) output,
 Mini USB-USB2.0 (Software Download/Configuration),
 Modular Connection (Maximum 16 devices),
 Snap-in type terminal,
 25mm width.

General Specifications

Supply	
Supply Voltage	24Vdc (±%20) or PLCBUS
Power Consumption	2,5W
Communication Ports	
Communication Port	1x RS-485 or PLCBUS
Program Installation/Configuration	1x USB (Mini USB2.0) or PLCBUS
Inputs	
Digital Inputs	-
Outputs	
Digital Outputs	14x (1,5A)
Reaction time	10msn
Environmental Conditions	
Operating / Storage Temperature	-10°C...+60°C / -20°C...+70°C
Mounting Type	Rail Mounting

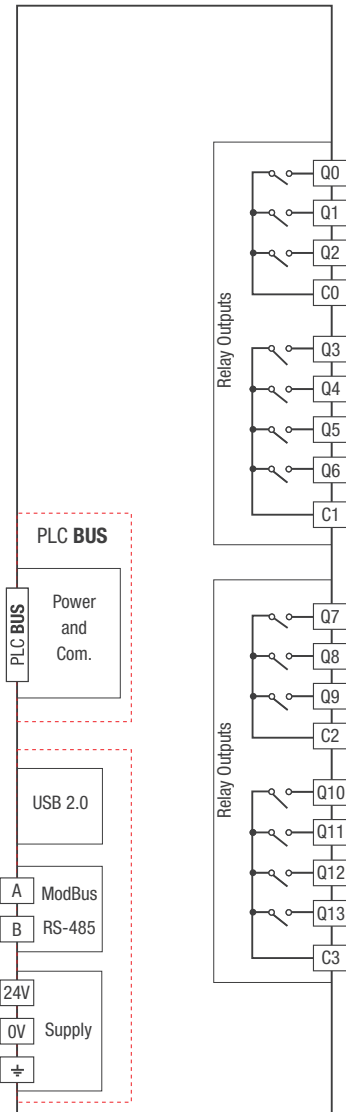

Product Codes

IPERTU Expansion Module	Digital Input	Analogue Input	Digital Output	Relay Output	Analogue Output	Communication Port	PID - ON/OFF Control Form
IPERTU-SMR1P1-00-00-22-00_1	-	-	-	14x	-	1x RS485 + 1x miniUSB 2.0	-
IPERTU-SMROPO-00-00-22-00_1	-	-	-	14x	-	PLC BUS	-

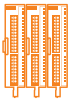

SGN4P1-00-00-00-00_1

SGN8P1-00-00-00-00_1

Compatible with Modbus RTU (RS-485) Master devices, Mini USB-USB2.0 (Software Download/Configuration), Ethernet DHCP Feature (Dynamic Host Configuration Protocol), USB, RS-485, supply and communication status led indicators.

* On the MODBUS-TCP side, 8 MASTER devices can be operated simultaneously ability to log in to query SLAVE devices.

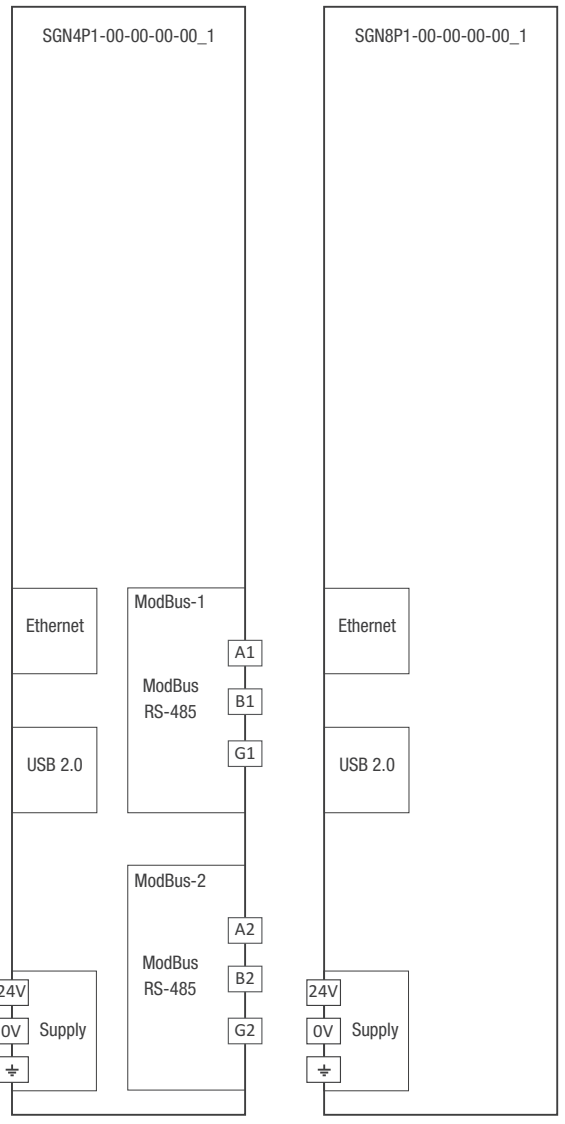

General Specifications

Supply	
Supply Voltage	24Vdc (±%20)
Power Consumption	2W
Communication Ports	
Communication Port	2x RS-485
Program Installation/Configuration	1x USB (Mini USB2.0)
Ethernet	1x Ethernet
Environmental Conditions	
Operating / Storage Temperature	-10°C...+60°C / -20°C...+70°C
Mounting Type	Rail Mounting

Product Codes

IPERTU Communication Modules	Communication-1 ModBus RS-485	Communication-2 ModBus RS-485	Ethernet	Mini USB2.0
IPERTU-SGN4P1-00-00-00-00_1	1x	1x	1x	1x
IPERTU-SGN8P1-00-00-00-00_1	-	-	1x	1x

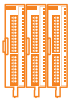

Universal Supply Input,
 100-240Vac (-15%...+10%) 50/60Hz,
 24Vdc ($\pm 10\%$) adjustable output voltage,
 2.5A / 60W@24Vdc,
 Active output led indicator,
 Output Load regulation < 1.5%,
 Output Line regulation < 1.5%,

* Internal supply to IPERTU PLC CPU and expansion modules via IPERTU BUS structure.
 (It should be installed on the far left of the devices)

IPERTU-MPS060-00-00-00-00_1

General Specifications _____

Supply	
Efficiency	> 84%
Starting current	max 33A@230 Vac
Output	
Power	60W 2,5A@24Vdc
Ripple	300 mVpp max
Environmental Conditions	
Operating / Storage Temperature	-20°C...+50°C / -30°C...+75°C
Mounting Type	Rail Mounting

Dimensions _____

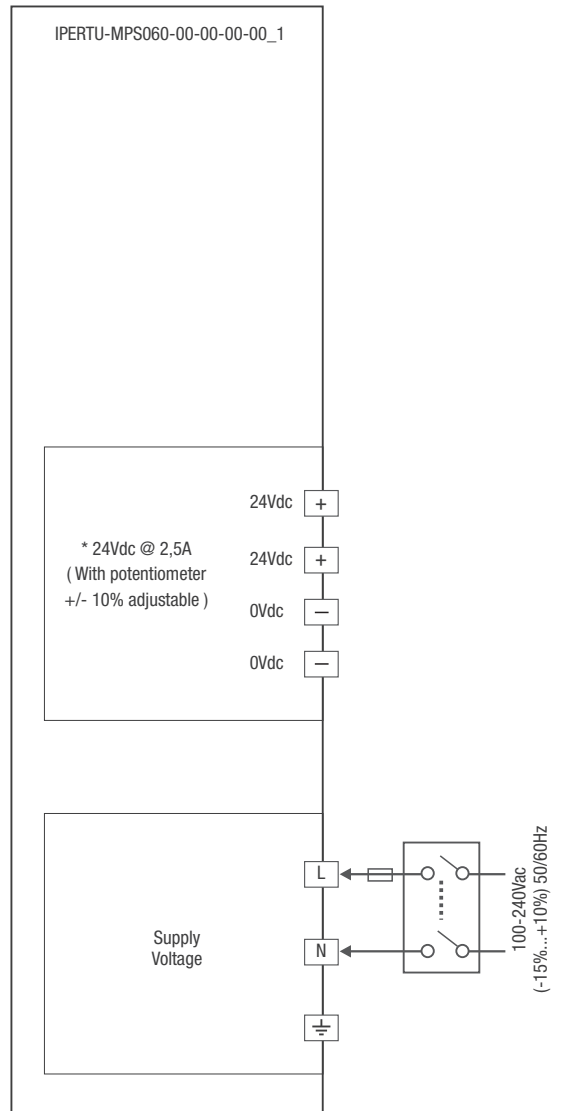
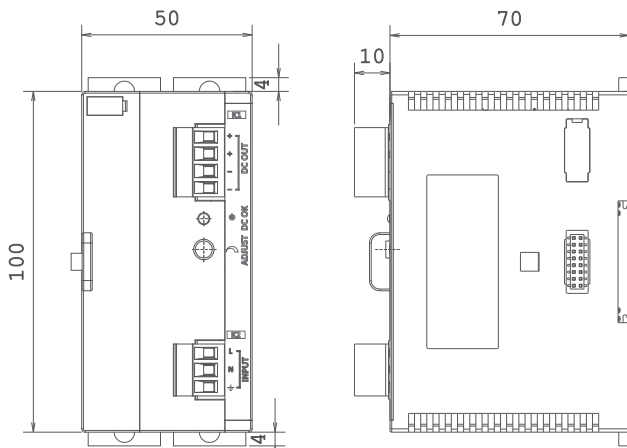

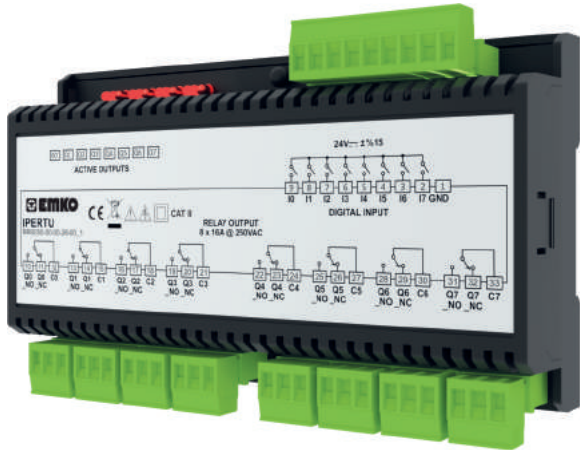
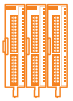

IPERTU-RR00S0-00-00-26-00_1

- 8x Digital inputs,
- 8x NO/NC Relay output (16A@250Vac),
- 8x Relay active leds.

General Specifications

Inputs	
Digital Inputs	8x Digital Inputs
Outputs	
Relay Outputs	8x (16A@250Vac)
Environmental Conditions	
Operating / Storage Temperature	-10°C...+60°C / -20°C...+70°C
Mounting Type	Rail Mounting

Dimensions

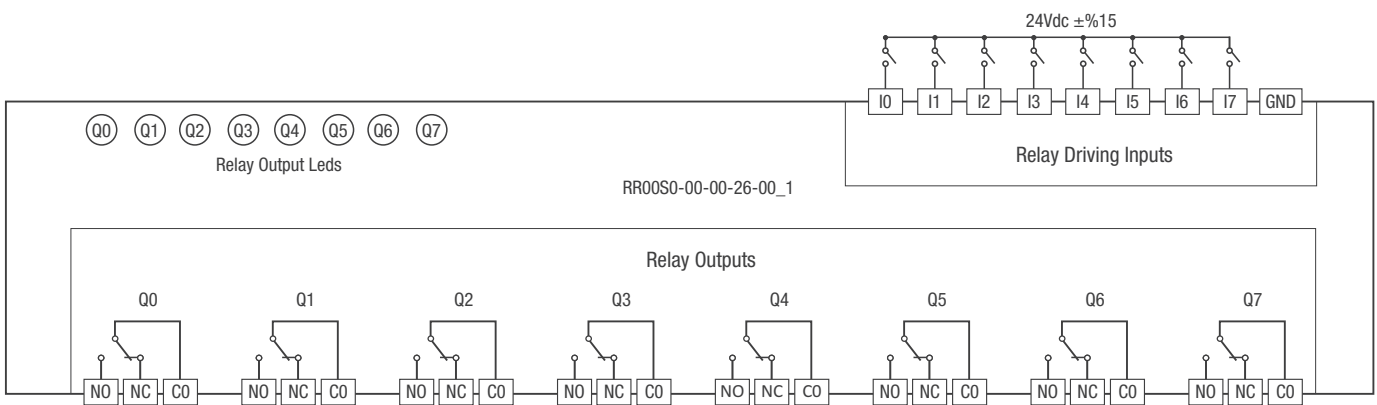
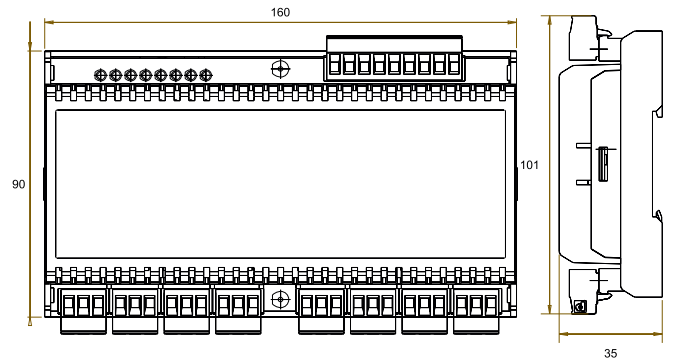

Product Codes

IPERTU Expansion Module	Digital Input	Analogue Input	Digital Output	Relay Output	Analogue Output	Communication Port	PID - ON/OFF Control Form
RR00S0-00-00-26-00_1	8x Digital Inputs	-	-	8x	-	-	-

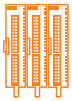

IPERTU I/O Modules Comparison Table

IPERTU Expansion Output Modules	Digital Input	Analogue Input	Digital Output	Relay Output	Analogue Output	Communication	PID / ON-OFF Control Form
IPERTU-SMR1P1-00-01-21-00_1	-	4x Pt-100, Pt-1000, Cu-50, PTC, NTC, 0...50mV	-	4x (NO) 1,5A	-	1x RS485 + 1x miniUSB 2.0	+
IPERTU-SMR1P1-00-03-21-00_1	-	2x Pt-100, Pt-1000, Cu-50, PTC, NTC, 0...50mV	-	4x (NO) 1,5A	-	1x RS485 + 1x miniUSB 2.0	+
IPERTU-SMR1P1-00-01-04-00_1	-	4x Pt-100, Pt-1000, Cu-50, PTC, NTC, 0...50mV	4x Transistor	-	-	1x RS485 + 1x miniUSB 2.0	+
IPERTU-SMR1P1-00-03-04-00_1	-	2x Pt-100, Pt-1000, Cu-50, PTC, NTC, 0...50mV	4x Transistor	-	-	1x RS485 + 1x miniUSB 2.0	+
IPERTU-SMR1P1-00-20-21-00_1	-	4x 0/2...10Vdc, 0...2/5Vdc, 0/4...20mA	-	4x (NO) 1,5A	-	1x RS485 + 1x miniUSB 2.0	+
IPERTU-SMR1P1-00-21-21-00_1	-	2x 0/2...10Vdc, 0...2/5Vdc, 0/4...20mA	-	4x (NO) 1,5A	-	1x RS485 + 1x miniUSB 2.0	+
IPERTU-SMR1P1-00-20-04-00_1	-	4x 0/2...10Vdc, 0...2/5Vdc, 0/4...20mA	4x Transistor	-	-	1x RS485 + 1x miniUSB 2.0	+
IPERTU-SMR1P1-00-21-04-00_1	-	2x 0/2...10Vdc, 0...2/5Vdc, 0/4...20mA	4x Transistor	-	-	1x RS485 + 1x miniUSB 2.0	+
IPERTU-SMR1P1-00-10-04-00_1	-	4x TC (J, K, R, S, T, L,...)	4x Transistor	-	-	1x RS485 + 1x miniUSB 2.0	+
IPERTU-SMR1P1-00-12-04-00_1	-	2x TC (J, K, R, S, T, L,...)	4x Transistor	-	-	1x RS485 + 1x miniUSB 2.0	+
IPERTU-SMR1P1-00-30-04-00_1	-	1x Universal Input	4x Transistor	-	-	1x RS485 + 1x miniUSB 2.0	+
IPERTU-SMR1P1-00-30-07-02_1	-	1x Universal Input	1x Transistor	-	1x (0...10Vdc, 0...20mA)	1x RS485 + 1x miniUSB 2.0	+
IPERTU-SMR1P1-03-00-20-00_1	8x	-	-	8x (NO) 1,5A	-	1x RS485 + 1x miniUSB 2.0	-
IPERTU-SMR1P1-03-00-02-00_1	8x	-	8x Transistor	-	-	1x RS485 + 1x miniUSB 2.0	-
IPERTU-SMR1P1-01-00-00-00_1	16x	-	-	-	-	1x RS485 + 1x miniUSB 2.0	-
IPERTU-SMR1P1-00-00-22-00_1	-	-	-	14x (NO) 1,5A	-	1x RS485 + 1x miniUSB 2.0	-
IPERTU-SMR1P1-00-00-01-00_1	-	-	15x Transistor	-	-	1x RS485 + 1x miniUSB 2.0	-

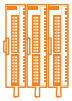

IPERTU I/O Modules Comparison Chart (with PLCBUS Communication)

IPERTU Expansion Output Modules	Digital Input	Analogue Input	Digital Output	Relay Output	Analogue Output	Communication	PID / ON-OFF Control Form
IPERTU-SMROPO-00-01-21-00_1	-	4x Pt-100, Pt-1000, Cu-50, PTC, NTC, 0...50mV	-	4x (NO) 1,5A	-	PLCBUS	+
IPERTU-SMROPO-00-03-21-00_1	-	2x Pt-100, Pt-1000, Cu-50, PTC, NTC, 0...50mV	-	4x (NO) 1,5A	-	PLCBUS	+
IPERTU-SMROPO-00-01-04-00_1	-	4x Pt-100, Pt-1000, Cu-50, PTC, NTC, 0...50mV	4x Transistor	-	-	PLCBUS	+
IPERTU-SMROPO-00-03-04-00_1	-	2x Pt-100, Pt-1000, Cu-50, PTC, NTC, 0...50mV	4x Transistor	-	-	PLCBUS	+
IPERTU-SMROPO-00-20-21-00_1	-	4x 0/2...10Vdc, 0...2/5Vdc, 0/4...20mA	-	4x (NO) 1,5A	-	PLCBUS	+
IPERTU-SMROPO-00-21-21-00_1	-	2x 0/2...10Vdc, 0...2/5Vdc, 0/4...20mA	-	4x (NO) 1,5A	-	PLCBUS	+
IPERTU-SMROPO-00-20-04-00_1	-	4x 0/2...10Vdc, 0...2/5Vdc, 0/4...20mA	4x Transistor	-	-	PLCBUS	+
IPERTU-SMROPO-00-21-04-00_1	-	2x 0/2...10Vdc, 0...2/5Vdc, 0/4...20mA	4x Transistor	-	-	PLCBUS	+
IPERTU-SMROPO-00-10-04-00_1	-	4x TC (J, K, R, S, T, L,...)	4x Transistor	-	-	PLCBUS	+
IPERTU-SMROPO-00-12-04-00_1	-	2x TC (J, K, R, S, T, L,...)	4x Transistor	-	-	PLCBUS	+
IPERTU-SMROPO-00-30-04-00_1	-	1x Universal Input	4x Transistor	-	-	PLCBUS	+
IPERTU-SMROPO-00-30-07-02_1	-	1x Universal Input	1x Transistor	-	1x (0...10Vdc, 0...20mA)	PLCBUS	+
IPERTU-SMROPO-03-00-20-00_1	8x	-	-	8x (NO) 1,5A	-	PLCBUS	-
IPERTU-SMROPO-03-00-02-00_1	8x	-	8x Transistor	-	-	PLCBUS	-
IPERTU-SMROPO-01-00-00-00_1	16x	-	-	-	-	PLCBUS	-
IPERTU-SMROPO-00-00-22-00_1	-	-	-	14x (NO) 1,5A	-	PLCBUS	-
IPERTU-SMROPO-00-00-01-00_1	-	-	15x Transistor	-	-	PLCBUS	-

Analogue Inputs					
Input Types	Scale (°C)	Scale (°F)	Input Types	Scale (°C)	Scale (°F)
Cu-50	-200...+200°C / 0,1°C	-328...+392°F / 0,1°F	V	0 +10V/1mV	
PT-100	-200...+650°C / 0,1°C	-328...+1202°F / 0,1°F	V	2 +10V/1mV	
PT-1000	-200...+650°C / 0,1°C	-328...+1202°F / 0,1°F	mA	0 +20mA / μ A	
PTC	-50.....+150°C / 0,1°C	-58...+302°F / 0,1°F	mA	4 +20mA / μ A	
NTC	-50.....+100°C / 0,1°C	-58...+212°F / 0,1°F	TC (J)	-200...+900°C / 0,1°C	-328...+1652°F / 0,1°F
mV	0+50mV / 10 μ V		TC (K)	-200...+1300°C / 0,1°C	-328...+2372°F / 0,1°F
V	0+2V / 1mV		TC (R)	0+1700°C / 0,1°C	32+3092°F / 0,1°F
V	0+5V / 1mV		TC (S)	0+1700°C / 0,1°C	32+3092°F / 0,1°F
ADC Resolution			15 bit		
Input Impedance			V > 48 k Ω	mA > 47 Ω	Other ~ 15,4 M Ω
Accuracy			% 0.2 (Full measuring range)		
Measuring Speed			Per channel 160msn		

Digital Inputs	
Type / Rated Input Voltage	NPN-PNP / 24Vdc
Level	Low Level < 7Vdc, High Level > 10Vdc
Input Impedance	>5,9k Ω
Maksimum Akim	6 mA
Response Time	20 μ sn
Measuring Speed	1-500msn filter option

Relay Outputs	
Relay Current	1,5A (Single channel)
Response Time	0'dan 1'e = 10 ms , 1'den 0'a = 5 ms

Digital Outputs	
Digital Output Current	0,3A (Single channel)
Transistor Supply	Externally 24Vdc supply
Response Time	~170 μ sn
Protection	Short circuit protection

Analogue Outputs	
Output Range	0-10V veya 0-20mA (Only one output caliber can be used at a time)
Accuracy	% 0.5 (Full measuring range)
Response Time	~ 200 ms

Dimensions

