

F5000 Flash lamp user manual

I. Safety Instruction

1. For security, please read the user manual carefully before initial operation;
2. Please be sure the power is off before connecting, the product is produced without fuse;
3. This system must not endanger life or property during the running failure or its security risks have been eliminated

II. Technical Specification

1. working voltage: 85-265VAC or 12-24VAC/DC
2. Loading capacity: <2.5W
3. Flicker Frequency: 1HZ
4. Working temperature: -20 ~ +60°C
5. IP Level: IP54
6. Size: φ90* 125mm

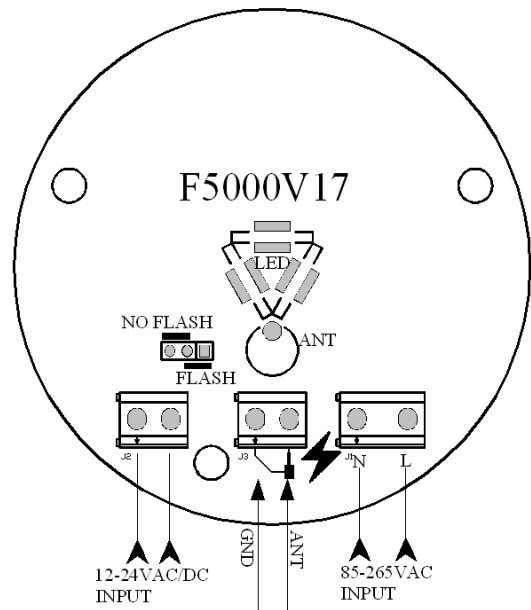
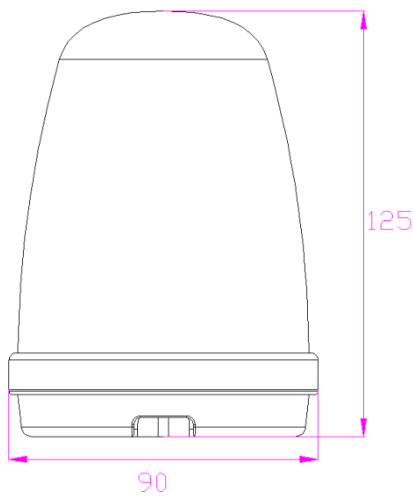

III. Connecting Instruction

1. Connect the wire with J1 if power supply is 85-265VAC
2. Connect the wire with J2 if power supply is 12-24VAC/DC
3. J3 is for connecting the antenna to extend the effective distance of controller

IV. Instructions

- 4.1 LED will flicker in 1HZ after power on
- 4.2 JP1 switch
It's the switch for switching LED in flickering or lighting,
When JP1 at FLASH, LED will flicker in 1Hz after power on;
When JP1 at NO FLASH, LED will light after power on

V. Installation

1. Open the package and take out the accessories for installation.



2. Stick the paper on the proper place, and then drill the hole.

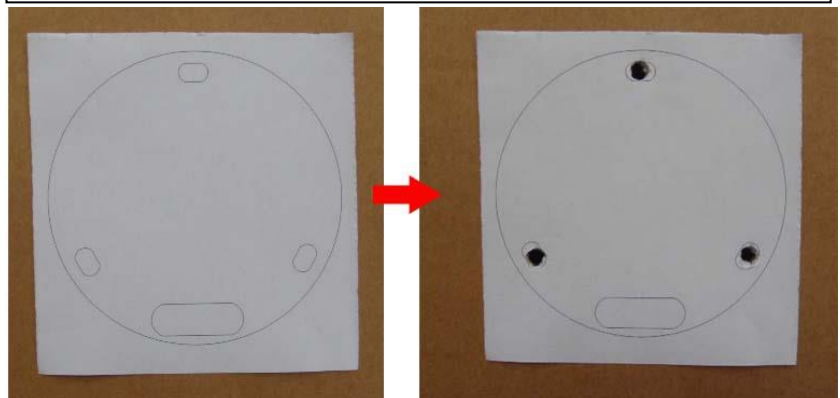

3. Take out the paper and install the expansion tube into the hole.

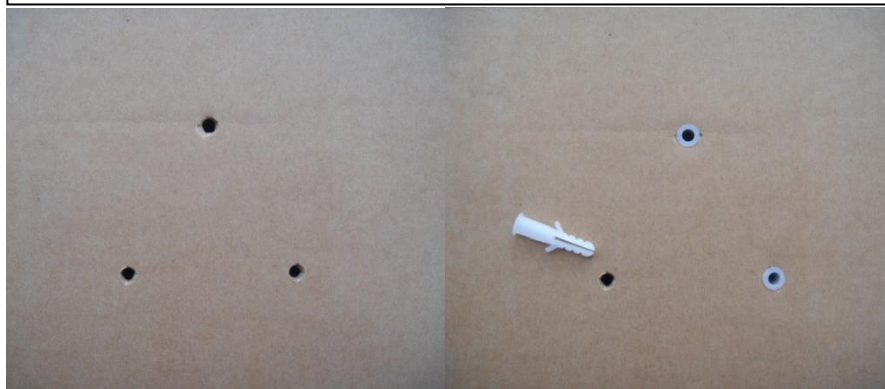

4. Crush the screw hole of bottom.



5. Take out the lamp ring as the direction showed.



6. Take off the yellow cover as the direction showed.



7. Connect the power supply and antenna.

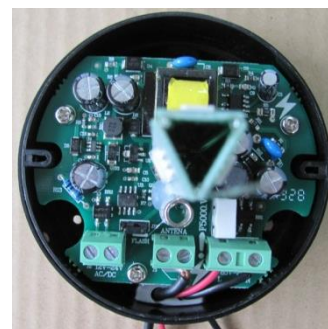

8. Put board into black base, and fix them with screw of $\Phi 4 \times 25$.

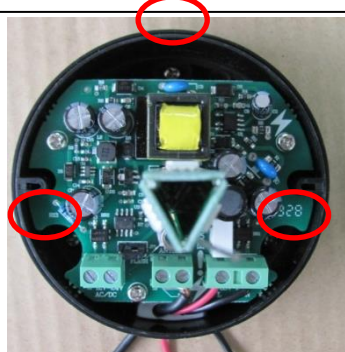

9. Install the black seal ring correctly.



10. Fasten the cover into the bottom.



12. Put on the decorative ring and finish the installation.



Holder install manual when wire outside the wall:

1. Open the package and take out the accessories for installation.



2. As it shown in the pic, drill two holes with 6mm diameter and 35mm deepness according to the spacing between the two fixed holes on the holder which is 55 mm, put the expansion tube into it.

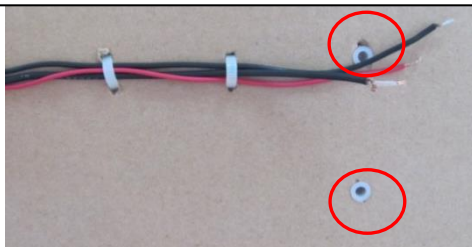

3. Poke through the thin wall of semi-circle at the corresponding side with sharp objects.



4. Make the wire through the circle, fix the holder on the wall by a self-tapping screw of $\Phi 3.8*30\text{mm}$.



5. Take out the lamp ring as the direction showed.



6. Take off the yellow cover as the direction showed.

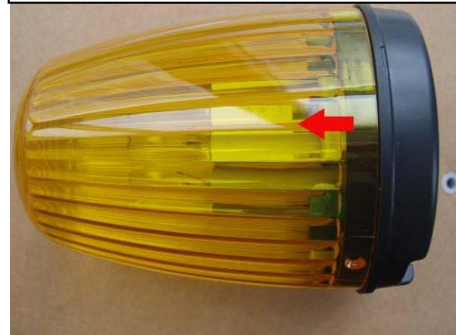

7. Crush the screw hole of bottom.



8. Connect the power wire first, then fix the lamp socket on the holder with self-tapping screw of $\Phi 3*12\text{mm}$.

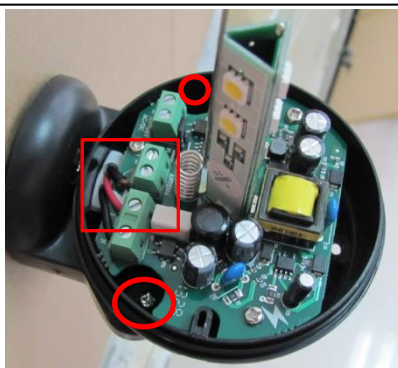

9. Install the seal ring and lamp cover, fix the lamp cover and the lamp socket with screw of $\Phi 2*8\text{mm}$ in the accessory.



10. Put on the decorative ring and finish the installation.



Holder install manual when wire inside the wall:

1. Open the package and take out the accessories for installation.



2. As it shown in the pic, drill two holes with 6mm diameter and 35mm deepness according to the spacing between the two fixed holes on the holder which is 55 mm, put the expansion tube into it.

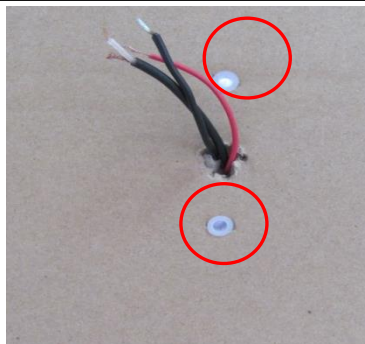

3. Fix the holder on the wall by a self-tapping screw of $\Phi 3.8*30\text{mm}$.



4. Take out the lamp ring as the direction showed.



5. Take off the yellow cover as the direction showed.



6. Poke the screw hole near the string hole as it shown in the picture with sharp objects.



7. Connect the power wire, then fix the lamp socket on the holder with self-tapping screw of $\Phi 3*12\text{mm}$.



8. Install the seal ring and lamp cover, fix the lamp cover and the lamp socket with screw of $\Phi 2*8\text{mm}$ in the accessory.



9. Put on the decorative ring and finish the installation.

