

# USER'S MANUAL

## VX Series

---

HANYOUNG NUX

21st AUGUST, 2018

**Be sure to read the "Safety information" before using the product, and use the product correctly**

# Index

Notice.....	4
Product introduction.....	11
◆ Features .....	11
◆ Suffix code.....	12
● Orderable codes (VX4).....	14
◆ Product specifications .....	16
● Input specifications (TC and RTD) .....	19
● Input specifications (DC current and voltage) .....	20
● Input specifications (remote input).....	20
◆ Components .....	21
● Basic components.....	21
● Components sold separately .....	21
◆ Insulation block diagrams .....	23
◆ Connection diagrams.....	24
◆ Part names and dimensions.....	25
◆ Assembly drawings.....	27
◆ Front design.....	28
● Icons and buttons.....	28
● LCD Display (Character).....	30
● Button functions .....	32
Product installation .....	34
◆ Precautions during installation.....	34
◆ Installation notes .....	34
◆ USB Loader connection .....	35
MMI and parameters.....	37
◆ Full mode configuration.....	38
◆ G.SV (SV Group).....	46
◆ G.CTL (Control Group).....	48

◆ G.ALM (Alarm Group).....	57
◆ G.TRS (Transfer & Remote Group).....	75
◆ G.SUB (Sub Group).....	79
◆ G.COM (Communication Group).....	85
◆ G.SET (Setup Group).....	87
◆ G.OUT (Output Group).....	90
◆ G.IN (Input Group).....	95
For your reference.....	97
◆ Term Descriptions.....	97
◆ Engineering Units.....	97
◆ Scale change of DCA, DCV, DCmV.....	98
◆ Changing the retransmission output range.....	99
◆ Error Message.....	101
Communication.....	103
◆ Communication map.....	103
● Process (address 0 ~ 99).....	103
● G.SV (address 100 ~ 199).....	104
● G.CTL (address 200 ~ 299).....	105
● G.ALM (address 300 ~ 399).....	106
● G.TRS (address 400 ~ 499).....	107
● G.SUB (address 500 ~ 599).....	108
● G.COM (address 600 ~ 699).....	110
● G.SET (address 700 ~ 799).....	110
● G.OUT (address 800 ~ 899).....	110
● G.IN (address 900 ~ 999).....	111
● USER MAP SETTING (address 721 ~ 740).....	111
● USER DATA (address 1200 ~ 1219).....	112
◆ BIT Information.....	114

- Now STS (Now Status) description ..... 115
- ERR\_STS (Error Status) description ..... 115
- SUB\_STS (Sub Output Status) description ..... 116
- ALM\_STS (Alarm Status) description ..... 117
- DI\_STS (Digital Input Status) description..... 117

## Notice

### ◆ Product introduction

Thank you for purchasing Hanyoung Nux products.

This user's manual explains the functions of the product, precautions, how to install and use it. Please read the user's manual carefully beforehand. In addition, please make it available for the end user and keep it where you can view it any time.

### ◆ Notice

This manual is intended for those who have a basic understanding of the basic principles of electrical and electronic equipment, knowledge of the equipment (system) to which this product applies, and knowledge of computers and communication.

### ◆ Safety information

The following safety information are intended to prevent unforeseen hazards or damages in advance by using the product safely and correctly.

The alerts are classified into "Danger", "Warning" and "Caution", with the following meaning:

 This symbol is intended to alert the user about situations or operations that can cause danger. Please read this symbol carefully and follow the instructions to avoid danger.

 Indicates an imminently hazardous situation which, if not avoided, will result in death or serious injury

 Indicates a potentially hazardous situation which, if not avoided, could result in death or serious injury

 Indicates a potentially hazardous situation which, if not avoided, may result in minor injury or property damage

 **DANGER**

- The input/output terminals are subject to electric shock risk. Never let the input/output terminals come in contact with your body or conductive substances.

 **WARNING**

- If there is a possibility of a serious accident due to malfunction or abnormality of this product, install an appropriate protection circuit on the outside.
- Since this product is not equipped with a power switch and fuse, install them separately on the outside (fuse rating: 250 VAC, 0.5 A).
- Please supply the rated power voltage, in order to prevent product breakdowns or malfunctions.
- The power supply should be insulated and limited voltage/current or Class 2, SELV power supply device.
- To prevent electric shocks and malfunctions, do not supply power until the wiring is completed.
- The product does not have an explosion-proof structure, so avoid using it in places with flammable or explosive gases.
- Never disassemble, modify, process, improve or repair this product, as it may cause abnormal operations, electric shocks or fires.
- Please disassemble the product after turning OFF the power. Failure to do so may result in electric shocks, product abnormal operations or malfunctions.
- Any use of the product other than those specified by the manufacturer may result in personal injury or property damage.
- Please use this product after installing it to a panel, because there is a risk of electric shock.
- When used in equipment with a high risk of personal injury or property damage

(examples: medical devices, nuclear control, ships, aircrafts, vehicles, railways, combustion devices, safety devices, crime/disaster prevention equipment etc.) install double safety devices and prevent accidents. Failure to do so may result in fire, personnel accident or property damage.

 **CAUTION**

- The contents of this manual may be changed without prior notification.
- Please make sure that the product specifications are the same as you ordered.
- Please make sure that there are no damages or product abnormalities occurred during shipment.

### **INSTALLATION**

- do not use it outdoors.
- use it in the ambient temperature and humidity ranges indicated in the instruction manual.
- use it in locations where corrosive gases (especially harmful gases, ammonia, etc.) and flammable gases are not generated.
- use it in places where vibrations and impacts are not directly applied to product body.
- use it in places without liquids, oils, chemicals, steam, dust, salt, iron, etc.  
(pollution degree 1 or 2).
- avoid places where large inductive interference, static electricity, magnetic noise are generated.
- avoid places with heat accumulation caused by direct sunlight, radiant heat, etc.
- use it in places with elevation below 2000 m.
- Installation Category II.

### **USAGE**

- Please do not wipe the product with organic solvents such as alcohol, benzene, etc.  
(wipe it with neutral detergents).

- When water enters, short circuit or fire may occur, so please inspect the product carefully.
- For thermocouple input, use the predetermined compensating cable (temperature errors occur when using ordinary cable).
- For RTD input, use a cable with small lead wire resistance and without resistance difference among 3 wires (temperature errors occur if the resistance value among 3 wires is different).
- Use the input signal line away from power line and load line to avoid the influence of inductive noise.
- Input signal line and output signal line should be separated from each other. If separation is not possible, use shield wires for input signal line.
- Use a non-grounded sensor for thermocouple (using a grounded sensor may cause malfunctions to the device due to short circuits).
- When there is a lot of noise from the power, we recommend to use insulation transformer and noise filter. Please install the noise filter to a grounded panel or structure, etc. and make the wiring of noise filter output and product power supply terminal as short as possible.
- Tightly twisting the power cables is effective against noise.
- If the alarm function is not set correctly, it will not be output in case of abnormal operation, so please check it before operation.
- When replacing the sensor, be sure to turn off the power.
- Use an extra relay when the frequency of operation (such as proportional operation, etc.) is high, because connecting the load to the output relay rating without any room shortens the service life. In this case, SSR drive output type is recommended.
  - \* When using electromagnetic switch: set the proportional cycle to at least 20 sec.
  - \* When using SSR: set the proportional cycle to at least 1 sec.
- Do not wire anything to unused terminals.
- Please wire correctly, after checking the polarity of the terminals.
- When you install this product to a panel, please use switches or circuit breakers compliant with IEC60947-1 or IEC60947-3.



- Please install switches or circuit breakers at close distance for user convenience.
- Please specify on the panel that, since switches or circuit breakers are installed, if the switches or circuit breakers are activated, the power will be cut off.
- We recommend regular maintenance for the continuous safe use of this product.
- Some components of this product may have a lifespan or deteriorate over time.
- The warranty period of this product, is 1 year, including its accessories, under normal conditions of use.
- The preparation period of the contact output is required during power supply. If used as a signal to external interlock circuit, etc. please use a delay relay together.
- If the user changes the product in case of malfunctions, the operation may be different due to set parameters differences even if the model name is the same. So, please check the compatibility.
- Before using the temperature controller, there may be a temperature deviation between the PV value of the temperature controller and the actual temperature, so please use the product after calibrating the temperature deviation.
- The write life of non-volatile memory (EEPROM) is one million times. When configuring the system, please make sure that the number of times that data are written to non-volatile memory does not exceed one million times.
- If you connect the USB loader to another device using a USB cable, additional input errors may occur depending on the target device to which the cable is connected (it is recommended not to use it for control/monitoring).

#### ◆ **Quality assurance**

- ✓ We do not assume any warranty or liability with respect to this product, except as stipulated in our quality assurance conditions
- ✓ We are not responsible for any direct or indirect damages suffered by users or third parties due to unforeseeable defects or natural disasters.

### ◆ **Quality assurance conditions of this product**

- ✓ The warranty period of this product is one year from its date of purchase. This product will be repaired free of charge in the event of malfunction occurring under normal use conditions set forth in this manual.
- ✓ Repairs due to breakdown occurring after the expiration of the warranty period of the product will be charged according to the standard determined by the company.
- ✓ In the following cases, even if the breakdowns occur within the warranty period, they will be charged
  - Breakdowns due to user's fault
  - Breakdowns due to natural disaster
  - - Breakdowns due to movements after installation
  - Breakdowns due to arbitrary product change or damage
  - Breakdowns due to power supply abnormality (such as power instability)
  - If A/S is required due to breakdowns, please contact the place of purchase, or our sales department

## ◆ Symbols

### ✓ Abbreviation symbols

Abbreviation	Name
PV	Process value
SV	Set value
AT	Auto-tuning
REM	Remote set value
RET	Retransmission output
SUB1	SUB1 output
SUB2	SUB2 output
SUB3	SUB3 output
SUB4	SUB4 output
HBA1	Heater break alarm 1
HBA2	Heater break alarm 2
CT1	Current transformer 1
CT2	Current transformer 2
LBA	Loop break alarm
EU	Engineering unit
EUS	Engineering unit span

# Product introduction

## ◆ Features

- High visibility: Wide viewing angle negative LCD
- Good readability: Displayable characters displayed by using 14 segment PV display window (11-segment SV value and 7-segment MV value)
- Reduced panel space: temperature controller depth 63 mm
- Improved durability of the operation keys: plastic key applied
- Improved input accuracy: 0.2% (K type, PT100Ω, room temperature)
- Fast sampling: 50 ms sampling
- Superior control algorithm: 2 DOF PID control
- Front function key: RUN/STOP, AT, manual/automatic output switching, lock on/off functions
- Flexible operability: parameter up/down moving structure implemented
- Easy setting: connect loader communication and set parameter batch
- Various options
  - Thermocouple, RTD, analog input
  - Standard control, heating and cooling control
  - Lamp control
  - 4 PID groups, 4 SV settings
  - Several alarm functions and high capacity relay (5A, 220VAC)
  - Loop break alarm (LBA), heater break alarm (HBA)
  - Retransmission output (RET), digital input (DI), remote input (REM)
  - RS485 communication (PC-Link, PC-Link Sum, Modbus ASCII, Modbus RTU)

◆ Suffix code

Model (Code)												Content			
(0)	(1)	(2)	(3)	(4)	(5)	(6)	(7)	(8)	(9)	(10)	(11)				
VX	<input type="checkbox"/> -	<input type="checkbox"/>	<input type="checkbox"/>	<input type="checkbox"/>	<input type="checkbox"/> -	<input type="checkbox"/>	<input type="checkbox"/>	<input type="checkbox"/>	<input type="checkbox"/>	<input type="checkbox"/>	<input type="checkbox"/>	LCD Digital Temperature Controller			
Size	2											48(W) × 96(H) × 63(D) mm			
	4											48(W) × 48(H) × 63(D) mm			
	7											72(W) × 72(H) × 63(D) mm			
	9											96(W) × 96(H) × 63(D) mm			
Sensor		U										Universal input			
OUT 1 (control output 1)			M									Relay output			
			S										Voltage pulse output (voltage pulse output for SSR drive)		
			C										Current output (4 ~ 20 mA output for SCR drive)		
OUT 2 (control output 2)			N									None			
			M										Relay output		
Power					A							100 - 240 VAC, 50 / 60 Hz			
Option			Sub output			A1							1 relay output (VX4 basic option)		
						A2								2 relay outputs (VX2,7,9 basic option)	
						A3								3 relay outputs (※* 1,* 2)	
						A4								4 relay outputs (※ *2)	
			Communication			C									None
			Retransmission output						T						None
Digital input (DI)											None				

		D2		2 digital inputs (DI 1 ~ 2)
		D4		4 digital inputs (DI 1 ~ 4)
	Current detection input (CT)			None
			H1	Current detection input (CT) 1 contact
			H2	Current detection input (CT) 2 contact
	Remote input (REM)			None
			R	Remote input (4 ~ 20 mA or 1 ~ 5 V) 1 contact

- ✓ Please refer to our website for orderable codes.
- ✓ \* 1) Not available for VX4. However, when OUT2 is selected as 'M', SUB3 can be used according to the parameter setting.
- ✓ \* 2) You can select from VX2, 7, 9 (VX4 is excluded)

● Orderable codes (VX4)

✓ Order code order

- Codes from (1) to (6)

Index	(0)	(1)	(2)	(3)	(4)	(5)	(6)	(7)	(8)	(9)	(10)	(11)	Suffix code
No	Model	Size	Input sensor	OUT1	OUT2	POWER	Sub output	Communication	Retransmission	DI	CT	Remote input	
1	VX	4	U	S	N	A	A1	□□□□□					VX4-UMNA-A1□□□□□
2							A2						VX4-UMNA-A2□□□□□
3							M						A1
4					A2								VX4-UMMA-A2□□□□□
5					N								A1
6							A2						VX4-USNA-A2□□□□□
7				M			A1						VX4-USMA-A1□□□□□
8					A2		VX4-USMA-A2□□□□□						
9				C	N		A1						VX4-UCNA-A1□□□□□
10							A2						VX4-UCNA-A2□□□□□
11					M		A1						VX4-UCMA-A1□□□□□
12							A2						VX4-UCMA-A2□□□□□

- Codes from (7) to (11)

Index	(0)	(1)	(2)	(3)	(4)	(5)	(6)	(7)	(8)	(9)	(10)	(11)	Suffix code	
No	Model	Size	Input sensor	OUT1	OUT2	POWER	Sub output	Communication	Retransmission	DI	CT	Remote input		
1	VX4-□□□□-□							-	-	-	-	-	VX4-□□□□-□	
2											R	VX4-□□□□-□R		
3											H1	VX4-□□□□-□H1		
4											H2	VX4-□□□□-□H2		
5											D2	-	VX4-□□□□-□D2	
6												H1	VX4-□□□□-□D2H1	
7												H2	VX4-□□□□-□D2H2	
8											D4	-	VX4-□□□□-□D4	
9										T	-	-	VX4-□□□□-□T	
10											R	VX4-□□□□-□TR		
11										C	-	-	-	VX4-□□□□-□C
12													R	VX4-□□□□-□CR
13												H1	VX4-□□□□-□CH1	
14												H2	VX4-□□□□-□CH2	
15											D2	-	VX4-□□□□-□CD2	
16											T	-	-	VX4-□□□□-□CT
17												R	VX4-□□□□-□CTR	



✓



◆ Product specifications

Classification		VX2	VX4	VX7	VX9
Input	Thermocouple type	K, J, E, T, R, B, S, L, N, U, W, PLII			
	Reference contact compensation	±1.5 °C (within -10~50 °C)			
	RTD type	JPT100, PT100			
	Allowable line resistance	Each 3 wire within 10Ω (but the resistance among 3 lines should be same)			
	DC voltage / current	1~5 V (4~20 mA), 0~5 V, 0~10 V, 0~50 mV, 0~100 mV			
	Sampling cycle	50 ms			
Control output	Relay output	<ul style="list-style-type: none"> <li>• Rated switching capacity :5A 250 VAC, 5 A 30 VDC</li> <li>• Max. switching power : 750 VA, 90 W</li> <li>• Max. switching voltage : 250 VAC, 110 VDC</li> <li>• Max. switching current : 5 A</li> <li>• Mechanical life : 20 million times (at 180 CPM)</li> </ul>			
	SSR output	Voltage pulse output, 12 V ± 1 VDC (load resistance min. 600 Ω)			
	(SCR output)	Linear current output, load resistance: max. 600 Ω ± 0.2% of FS ± 1 digit			
Control	type	ON/OFF, PID control, 2DOF PID control			
	Output operation	Reverse action, direct action			
Display part	Display method	Wide viewing angle LCD			
	PV character (H * W) mm	(20.5 x 6.9)	(15.2 x 6.8)	(19.8 x 9.3)	(29.0 x 13.6)
	SV character (H * W) mm	(12.8 x 5.9)	(7.4 x 3.9)	(10.2 x 4.9)	(15.0 x 7.2)
	MV character (H * W) mm	(9.3 x 4.4)	-	(7.5 x 3.3)	(11.0 x 4.8)

Memory	Non-volatile memory life	EEPROM unlocked: when setting E2P.L: OFF in G.SET group (EEPROM life: 1 million times write guaranteed) / EEPROM locked: when setting E2P.L: ON in G.SET group - store in RAM	
USB loader	Communication method	UMS 2.0	
	Protocol	<ul style="list-style-type: none"> <li>• Protocol : PC-LINK</li> <li>• Baudrate : 38400 bps</li> <li>• Start bit : 1 bit</li> <li>• Data bit : 8bit</li> <li>• Parity bit : None</li> <li>• Stop bit : 1bit</li> </ul>	
	Communication distance	Max. 5 m	
Option	Alarm (Relay) output	1~ 4 contacts, rated switching capacity: 5A 250 VAC, 5 A 30 VDC	
	DI	2 contacts or 4 contacts	
	Retransmission output	Linear current output, load resistance: max. 600 $\Omega$ $\pm$ 0.2% of FS $\pm$ 1 digit	
	Remote input	1 input, 4 ~ 20 mA (1 ~ 5 V)	
	Current detection input	1 contact or 2 contacts	
	RS-485	Communication method	EIA RS485 standard, 2-wire half-duplex
		Max. connections	31 (address setting 1~99 available)
		Communication sequence	No sequence
		Communication distance	Within 1.2 km
		Baud Rate	4800, 9600, 14400, 19200, 38400, 57600 BPS

		Start bit	1 bit		
		Data length	7 or 8 bit		
		Parity bit	NONE, EVEN, ODD		
		Stop bit	1 or 2 bit		
		Protocol	PC-LINK STD, PC-LINK SUM, MODBUS-ASCII, MODBUS-RTU		
		Response time	Actual response time= processing time+(response time X 50 ms)		
Power	Power voltage	100 - 240 VAC, 50 / 60 Hz			
	Voltage fluctuation rate	±10 % of power voltage			
	Insulation resistance	Min. 20 MΩ, 500 VDC			
	Dielectric strength	3,000 VAC. 50/60 Hz for 1 minute (between 1st and 2nd terminal)			
	Power consumption	Max. 8.5 VA	Max. 8.5 VA	To be announced	To be announced
	Ambient temperature & humidity	-10 ~ 50 °C, 35 ~ 85 % RH (without condensation)			
	Storage temperature	-25 ~ 65 °C			
Approval		  	To be announced	To be announced	
		<ul style="list-style-type: none"> <li>■ Electrostatic discharge (ESD) : KN61000-4-2</li> <li>■ EFT(RS) : KN61000-4-3</li> <li>■ SURGE : KN61000-4-5</li> <li>■ Conductivity RF(CS) : KN61000-4-6</li> </ul>			
		IP66 (product front)	To be announced	To be announced	To be announced
Weight (g)	202	120	To be announced	To be announced	

● Input specifications (TC and RTD)

Classification	Type	No	Display	Temperature range		Tolerance
				(°C)	(°F)	
Thermocouple	K	1	K0	-200 ~ 1370	-328 ~ 2498	±0.2 % of FS ± 1 digit
		2	K1	-100.0 ~ 500.0	-148 ~ 932	
	J	3	J0	-200 ~ 1200	-328 ~ 2192	
		4	J1	-199.9 ~ 900.0	-328 ~ 1652	
	E	5	E1	-199.9 ~ 900.0	-328 ~ 1652	
	T	6	T1	-199.9 ~ 400.0	-328 ~ 752	
	R	7	R0	0 ~ 1700	32 ~ 3092	
	B	8	B0	100 ~ 1800	212 ~ 3272	±0.2 % of FS ± 1 digit 100~200 °C : ±2.0 % of FS ± 1 digit
	S	9	S0	0 ~ 1700	32 ~ 3092	±0.2 % of FS ± 1 digit
	L	10	L1	-199.9 ~ 900.0	-328 ~ 1652	
	N	11	N0	-200 ~ 1300	-328 ~ 2372	
	U	12	U1	-199.9 ~ 400.0	-328 ~ 752	
	W	13	W0	0 ~ 2300	32 ~ 4172	
	PLII	14	PL0	0 ~ 1300	32 ~ 2372	
RTD	JPt100	20	JPt0	-200 ~ 500	-328 ~ 932	±0.2 % of FS ± 1 digit
		21	JPt1	-199.9 ~ 500.0	-328 ~ 932	
	Pt100	22	Pt0	-200 ~ 640	-328 ~ 1184	
		23	Pt1	-199.9 ~ 640.0	-328 ~ 1184	

● Input specifications (DC current and voltage)

Classification	Type	No	Display	Scale range	Tolerance
Direct current	4 ~ 20mA	30	1-5V	-1999 ~ 9999	±0.2 % of FS ± 1 digit
(VDC / mV DC)	1 ~ 5V	30	1-5V		
	0 ~ 5V	31	5V		
	0 ~ 10V	32	10V		
	0 ~ 50mV	33	0.05V		
	0 ~ 100mV	34	0.1V		

※ When direct current is used, it is recommended to connect 250 Ω (0.1% or less, high precision) resistor in parallel to the outside of the terminal. Please note that the 250 Ω (1%) resistor included with the product is not a precision resistor.



● Input specifications (remote input)

Input	TYPE	Scale range	Tolerance
Direct current	4 ~ 20 mA	Same as input setting range	±0.2 % of F.S ± 1 digit
Direct voltage	1 ~ 5 V		

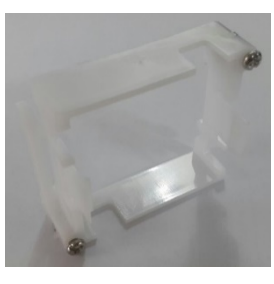
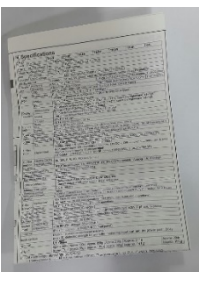
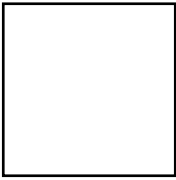

※ When direct current is used, it is recommended to connect 250 Ω (0.1% or less, high precision) resistor in parallel to the outside of the terminal. Please note that the 250 Ω (1%) resistor included with the product is not a precision resistor.

## ◆ Components

### ● Basic components

Main body	Bracket	Instruction manual	Rubber packing	250 Ω resistor (1 or 2 EA depending on the option)
				

### ● Components sold separately

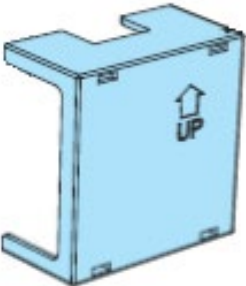
USB Loader Cable (NMC-UM210)	Current detector (CT) (CT-70)	Protective cover	
			For VX2 : TC2A-COV For VX4 : TC4A-COV For VX7 : TC7A-COV For VX9 : TC9A-COV

✓ USB Loader Cable ※ sold separately (NMC-UM210) USB2.0 Mini 5PIN Cable

- USB2.0 Mini 5 pin Cable



✓ Current detector ※ sold separately (CT-70), available with HBA option (1000:1, min. 50 A)

- Current ratio 1000: 1, current detection range 0.0 ~ 50.0 A

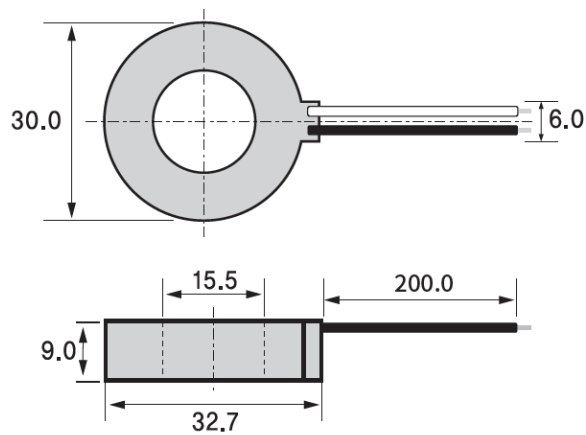

✓ Protective cover ※ sold separately (TC2A-COV, TC4A-COV, TC7A-COV, TC9A-COV)

- For VX2: TC2A-COV
- For VX4: TC4A-COV
- For VX7: TC7A-COV
- For VX9: TC9A-COV

◆ Insulation block diagrams

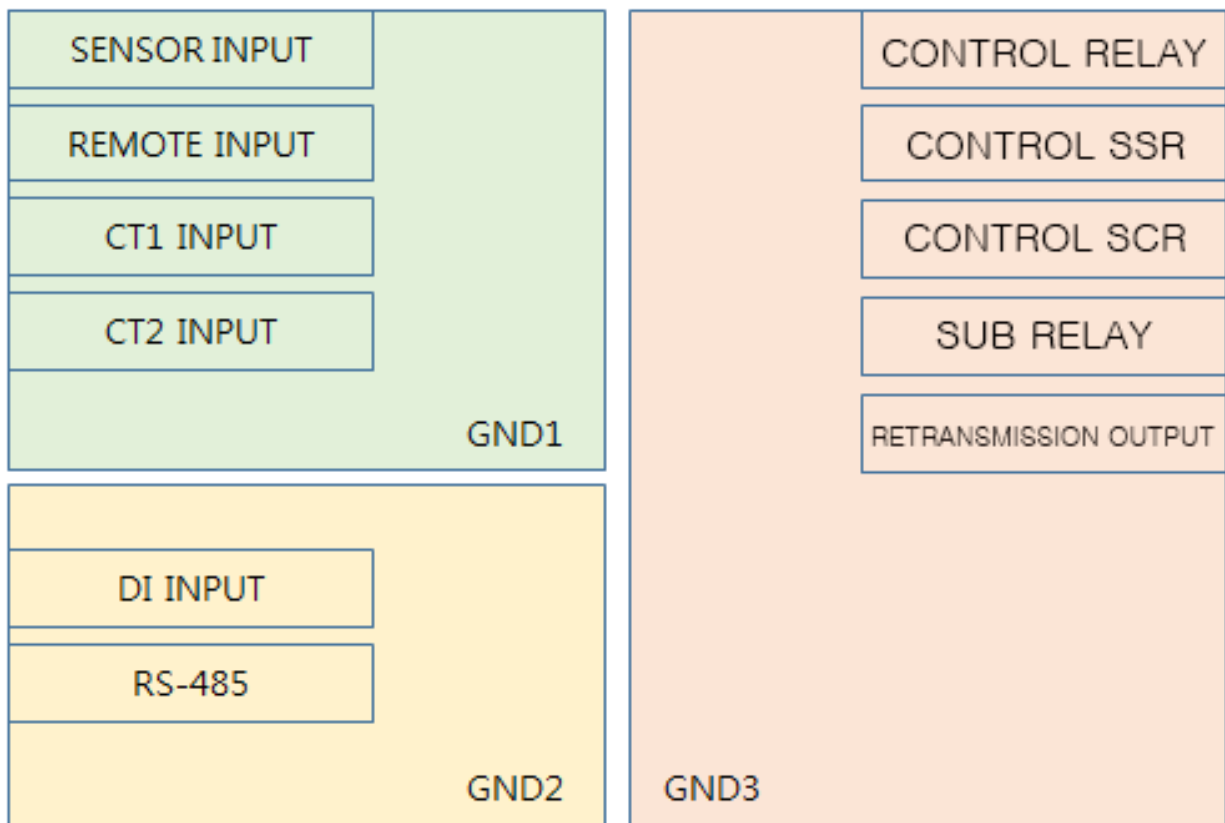



◆ Connection diagrams

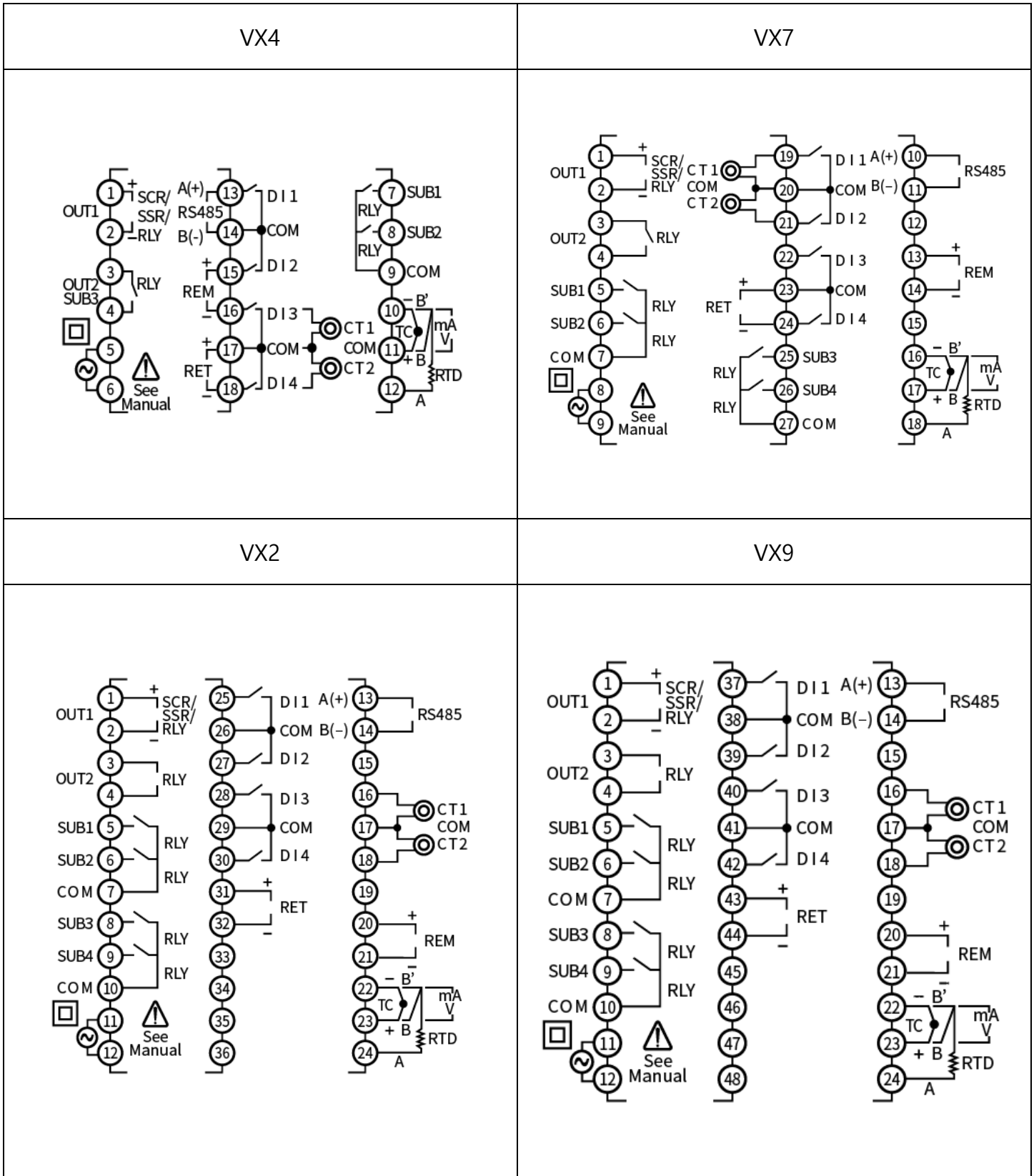

◆ Part names and dimensions

✓ Product dimensions

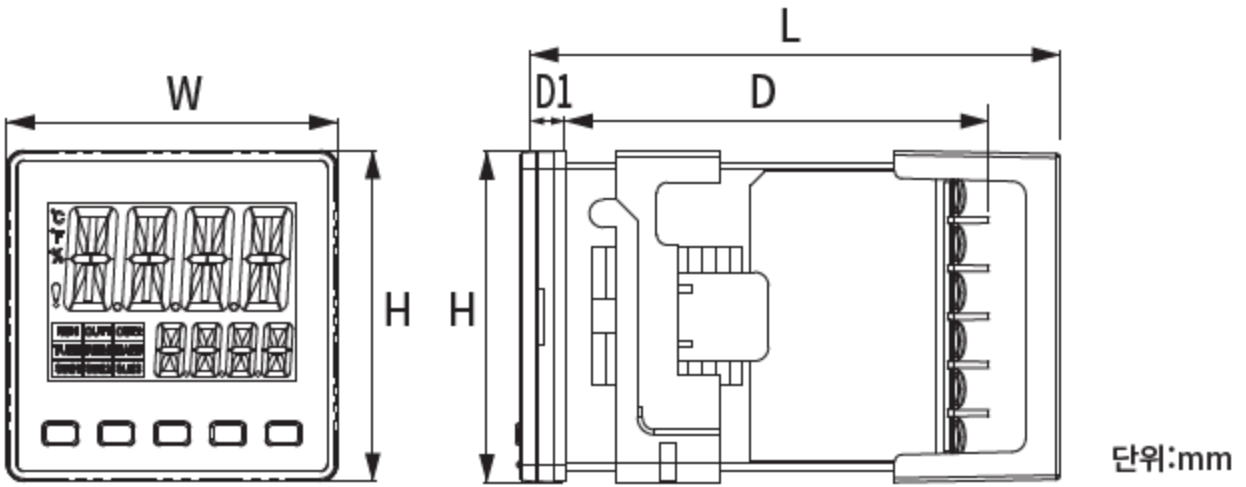

✓ Panel cutout

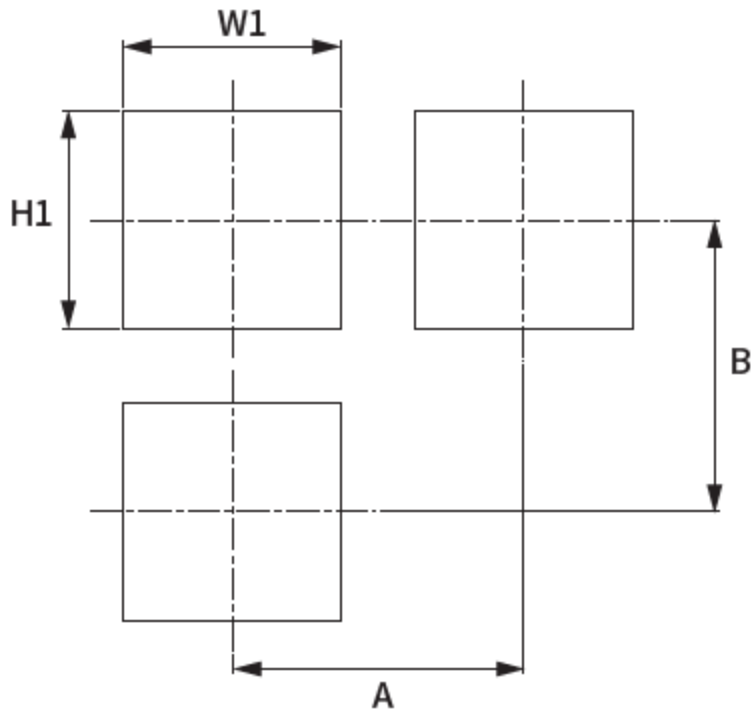

✓ Protective cover dimensions

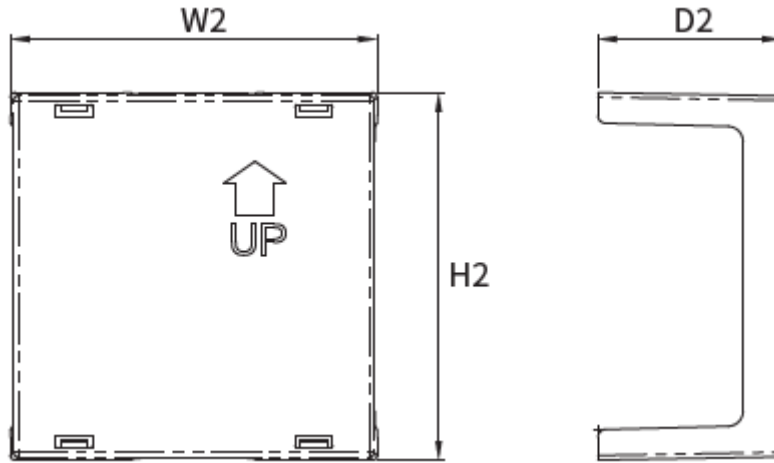

Unit: mm

Classification	Type	VX2	VX4	VX7	VX9
Product dimensions	W	48.0	48.0	72.0	96.0
	H	96.0	48.0	72.0	96.0
	D	63.0	63.0	63.0	63.0
	D1	5.5	5.0	5.5	5.5
	L	78.4	78.4	78.4	78.4
Panel cutout	W1 *1)	45.0	45.0	69.0	93.0
	H1 *1)	93.0	45.0	69.0	93.0
	A	70.0	60.0	83.0	117.0
	B *2)	122.0	60.0	100.0	117.0
Protective cover	W2	48.4	48.0	71.8	96.0
	H2	94.4	48.1	71.8	96.0
	D2	26.9	24.0	26.9	26.9

\* 1) +0.5 mm tolerance applied

\* 2) 100.0 mm applied when using USB Loader cable in VX4

✓ Terminals

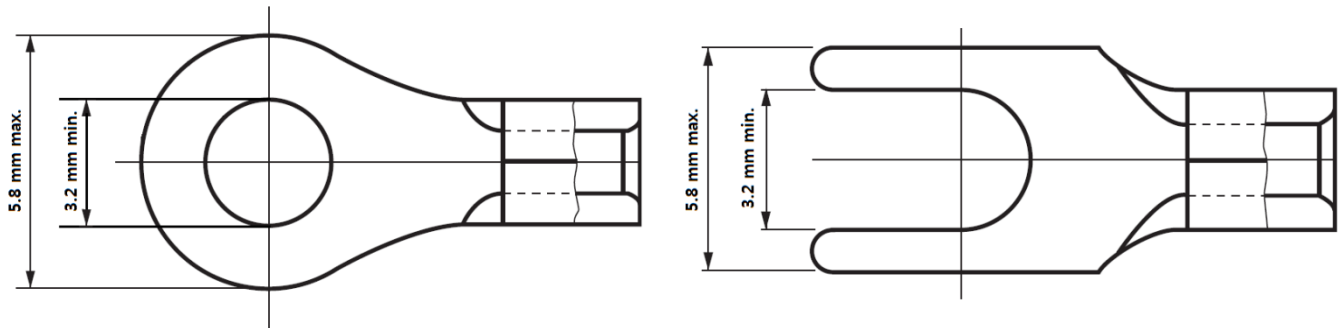

◆ **Assembly drawings**

✓ Protective covers

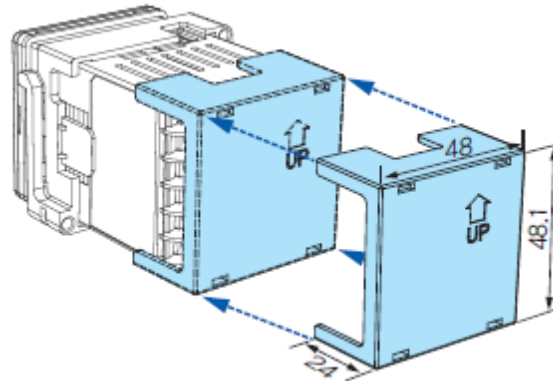



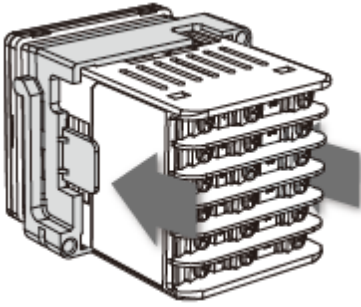
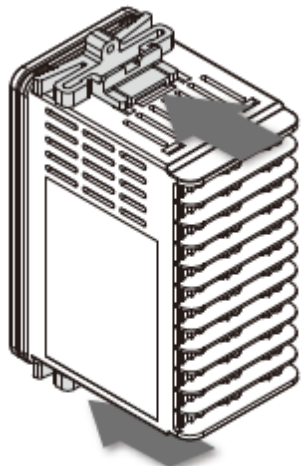







✓ Bracket

VX4	VX2, VX7, VX9
	

◆ Front design

● Icons and buttons

✓ LCD Icon description

No.	Segment		Description
1	PV	Present value	Displays PV value in operating mode
			Displays parameter name in menu mode
2	SV (or MV)	Set value or output value	Displays SV or control output value in operating mode
			Displays parameter set value in menu mode
3	°C °F %	Unit	Displays °C, °F, %, or no unit depending on the value set on unit.
		TUNING	Blinking during auto tuning
4		RUN or STOP status	Turns on during control
		Output 1 status	Control output 1 blinks proportionally to 0 ~ 100%)
		Output 2 status	Control output 2 blinks proportionally to 0 ~ 100%)
		Communication status	Turns on for 0.5 sec. during communication (turns on for 2 sec. during communication error)
		Remote input activation	Turns on when remote input is set
		Manual output status	Turns on when manual output is set
		Sub output 1 status	Turns on when sub output 1 is ON
		Sub output 2 status	Turns on when sub output 2 is ON
		Sub output 3 status	Turns on when sub output 3 is ON
	Sub output 4 status	Turns on when sub output 4 is ON	

	<b>TUNE</b>	TUNING	Blinks for 1 sec. during Auto-Tuning
	<b>LOCK</b>	Lock	Turns on when lock is set)
5	MD	Mode button	Refer to "button function description"
	SET	Set button	
	⏪	R/S or SHIFT button	
	⏴	Down button	
	⏵	Up button	

✓ VX4

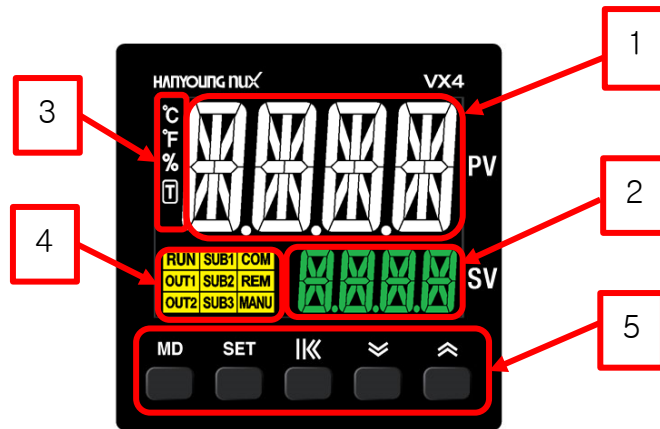

- LCD Display (Character)

- ✓ PV 14-Segments character

- Number display (0~9)

0	1	2	3	4	5	6	7	8	9
0	1	2	3	4	5	6	7	8	9

- Alphabet display (A~Z)

A	B	C	D	E	F	G	H	I	J
A	B	C	D	E	F	G	H	I	J
K	L	M	N	O	P	Q	R	S	T
K	L	M	N	O	P	Q	R	S	T
U	V	W	X	Y	Z				
U	V	W	X	Y	Z				

- ✓ SV 11-Segments character

- Number display (0~9)

0	1	2	3	4	5	6	7	8	9
0	1	2	3	4	5	6	7	8	9

- Alphabet display (A~Z)

A	B	C	D	E	F	G	H	I	J
A	b	C	d	E	F	G	H	I	J
K	L	M	N	O	P	Q	R	S	T
K	L	M	N	O	P	Q	R	S	T
U	V	W	X	Y	Z				
U	V	W	X	Y	Z				

✓ MV 7-Segments character

- Number display (0~9)

0	1	2	3	4	5	6	7	8	9
0	1	2	3	4	5	6	7	8	9





- Alphabet display (A~Z)

A	B	C	D	E	F	G	H	I	J
		C					H		
K	L	M	N	O	P	Q	R	S	T
				O					
U	V	W	X	Y	Z				



- Button functions

- ✓ General button functions

✓ Button name	Key	Operating mode				Menu mode	
		Control / monitoring	SV setting	MV	Manual MV	Group	Parameter
Mode		*1	-	*1	*2	*2	
Set		SV edit Mode shift	SV save	-	-	Edit parameter/move within group	Move to next parameter after saving value
Shift			Digit position Shift	-	Digit position Shift	-	Digit position Shift
Down			Decrease value	-	Decrease value	Shift among parameters/shift group	Decrease/change value
Up			Increase value	-	Increase value		Increase/change value

\* 1: When you click Mode key, the control output value is displayed. When you click mode key again, the SV value is displayed.

\* 2: Refer to the Menu key description

✓ Function key description

No	Hot Key	Content
1	Press <b>SET</b> + <b>  K</b> for 3 sec.	Lock / unlock
2	Press <b>SET</b> + <b>⇩</b> for 3 sec.	Manual / automatic output mode
3	Press <b>SET</b> + <b>⇧</b> for 3 sec.	Auto-tuning
4	Press <b>  K</b> for 2 sec.	RUN / STOP
5	<b>⇩</b> or <b>⇧</b>	Release during alarm latch

✓ Menu key description

No	Combination Key	Content
1	Press <b>MD</b> for 1 sec.	Simplified menu (SIMPLE MMI) Go to operating mode in MENU entry mode
2	Press <b>MD</b> + <b>SET</b> for 1 sec.	Full menu (FULL MMI)
3	Press <b>MD</b> + <b>  K</b> for 1 sec.	Basic menu (BASIC MMI)

## Product installation

### WARNING

#### ◆ Precautions during installation

#### ◆ Installation notes

- ✓ To prevent electric shock or device breakdown, turn off the power before installing or removing the product.
- ✓ Please use this product after installing it to a panel, because there is a risk of electric shock.
- ✓ Do not install the product in any of the following places:
  - Places where a person may touch a terminal
  - Places directly exposed to mechanical vibrations or shocks
  - Places exposed to corrosive or flammable gases
  - Places with large temperature change
  - Places with excessively high or low temperatures
  - Places directly exposed to sunlight
  - Places highly influenced by electromagnetic waves
  - Places with high moisture levels
  - Places with flammable objects
  - Places with high presence of dust, salt, etc.

◆ **USB Loader connection**

The communication loader connection uses the communication loader cable (sold separately) to connect the PC and VX. The parameter setting/backup of the VX is possible through the Hanyoung Nux communication operation program (TCS).

✓ Loader cable connection position

● **VX4 (top view)**

● **VX2**

● **VX7, VX9**

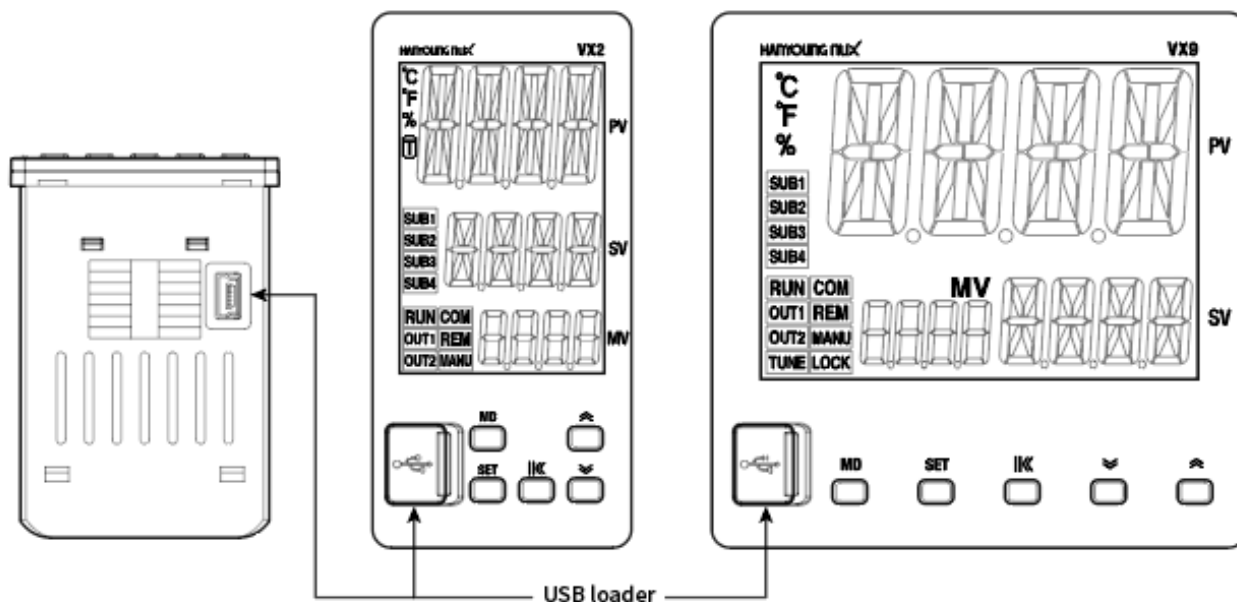

✓ Loader & PC USB Loader connection method

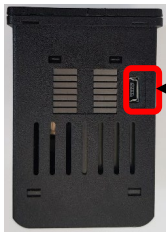

VX4 top



1m USB communication cable  
(sold separately: NMC-UM210)



USB port

PC

# MMI and parameters

## Parameter configuration

**How to read parameters (example)**

Parameter name: <100> (SV) Set value (SV) number (1.1-4)

Initial value, description and display range: <100> (SV) Set value (SV) number (1.1-4)

**How to change parameter set values**

How to parameter change mode: Press **SET**

Parameter change mode: Press **OK**, **ESC**, **←**, **→**

Save parameter set values and move to next parameter: Press **SET**

**Operation mode**

**Full Menu:** press and hold **MD** + **SET** for 1 sec.

- CONTROL group**
  - <0100> > Set value (SV) number (1.1-4)
  - <0101> > Auto tuning mode (ON/OFF or ON)
  - <0102> > Set value (SV) high limit (>1370, refer to input range)
  - <0103> > Set value (SV) low limit (>1370, refer to input range)
  - <0104> > Set value 2 (SV2) (>1300, refer to input range)
  - <0105> > Set value 1 (SV1) (>1300, refer to input range)
  - <0106> > Set value 4 (SV4) (>1300, refer to input range)
  - <0107> > Proportional band (heating) (>1.0, 0.01-1.0)
  - <0108> > Integral time (heating) (>1.0, 0.01-1.0)
  - <0109> > Derivative time (heating) (>0.0, 0.01-1.0)
  - <0110> > Manual reset (>1.0, 0.01-1.0)
  - <0111> > Proportional band (cooling) (>1.0, 0.01-1.0)
  - <0112> > Integral time (cooling) (>1.0, 0.01-1.0)
  - <0113> > Derivative time (cooling) (>0.0, 0.01-1.0)
  - <0114> > Heating cooling deadband (>1.0, 100.0-500.0)
- ALARM group**
  - <0200-in-1364> > Alarm n type (n=1, 2-13)
  - <0201-in-1364> > Alarm n in-voice (n=1)
  - <0202-in-1364> > Alarm n deadband (n=1)
  - <0203-in-1364> > Alarm n output hold status (n=1, 2, 3, 4)
  - <0204-in-1364> > Loop break alarm time (n=1, 2, 3, 4)
  - <0205-in-1364> > Loop break alarm set value (n=1, 2, 3, 4)
  - <0206-in-1364> > Loop break alarm deadband (n=1, 2, 3, 4)
  - <0207-in-1364> > Loop break alarm output hold status (n=1, 2, 3, 4)
  - <0208> > Heater break alarm 1 set value (>0.0, 1.0-50.0)
  - <0209> > Heater break alarm 1 deadband (>0.0, 1.0-50.0)
  - <0210> > Heater break alarm 2 set value (>0.0, 1.0-50.0)
  - <0211> > Heater break alarm 2 deadband (>0.0, 1.0-50.0)
  - <0212> > Current detection 2 monitoring (>1.0, 0.01-1.0)
  - <0213> > Heater break alarm output hold status (n=1, 2, 3, 4)
- TRANS group**
  - <0400> > Detransmission output type (>P(P), P(M), M)
  - <0401> > Detransmission output high limit (>1370, m=1)
  - <0402> > Detransmission output low limit (>1370, m=1)
  - <0403> > Detransmission output high adjust. area (>0, m=1)
  - <0404> > Detransmission output low adjust. area (>0, m=1)
  - <0405-in-1364> > Alarm n ON delay time (>0.0-999)
  - <0406-in-1364> > Alarm n OFF delay time (>0.0-999)
  - <0407-in-1364> > Alarm n contact type (>N, N(D) or N(C))
  - <0408> > Alarm n output hold (>ON, OFF or ON)
  - <0409> > Alarm n input high adjust. area (>0, m=1)
  - <0410> > Alarm n input low adjust. area (>0, m=1)
  - <0411> > Alarm n output hold (>ON, OFF or ON)
- SUB group**
  - <0500> > Sub 1 output type (>A(M), m=1)
  - <0501> > Sub 2 output type (>A(M), m=1)
  - <0502> > Sub 3 output type (>A(M), m=1)
  - <0503> > Sub 4 output type (>A(M), m=1)
  - <0504-in-1364> > Alarm n ON delay time (>0.0-999)
  - <0505-in-1364> > Alarm n OFF delay time (>0.0-999)
  - <0506-in-1364> > Alarm n contact type (>N, N(D) or N(C))
  - <0507-in-1364> > Alarm n output hold (>ON, OFF or ON)
  - <0508> > Alarm n input high adjust. area (>0, m=1)
  - <0509> > Alarm n input low adjust. area (>0, m=1)
  - <0510> > Alarm n output hold (>ON, OFF or ON)
  - <0511> > Alarm n ON delay time (>0.0-999)
  - <0512> > Alarm n OFF delay time (>0.0-999)
  - <0513> > Alarm n contact type (>N, N(D) or N(C))
  - <0514> > Alarm n output hold (>ON, OFF or ON)
  - <0515> > Alarm n input high adjust. area (>0, m=1)
  - <0516> > Alarm n input low adjust. area (>0, m=1)
  - <0517> > Alarm n output hold (>ON, OFF or ON)
  - <0518> > Alarm n ON delay time (>0.0-999)
  - <0519> > Alarm n OFF delay time (>0.0-999)
  - <0520> > Alarm n contact type (>N, N(D) or N(C))
  - <0521> > Alarm n output hold (>ON, OFF or ON)
  - <0522> > Alarm n input high adjust. area (>0, m=1)
  - <0523> > Alarm n input low adjust. area (>0, m=1)
  - <0524> > Alarm n output hold (>ON, OFF or ON)
  - <0525> > Alarm n ON delay time (>0.0-999)
  - <0526> > Alarm n OFF delay time (>0.0-999)
  - <0527> > Alarm n contact type (>N, N(D) or N(C))
  - <0528> > Alarm n output hold (>ON, OFF or ON)
  - <0529> > Alarm n input high adjust. area (>0, m=1)
  - <0530> > Alarm n input low adjust. area (>0, m=1)
  - <0531> > Alarm n output hold (>ON, OFF or ON)
- INPUT group**
  - <0600> > Input type (>I, m=1)
  - <0601> > Input bias (>0, m=1)
  - <0602> > Decimal point position (>1, m=1)
  - <0603> > Scale high limit (>100.0, 1000-9999)
  - <0604> > Scale low limit (>0.0, 1000-9999)
  - <0605> > ON/OFF control compensation (>ON, OFF or ON)
  - <0606> > Output filter (>OFF, OFF or 1-120)
  - <0607> > Input bias (>0, m=1)
- OUTPUT group**
  - <0800> > OUT1 control mode (>P, ON, OFF or PID)
  - <0801> > OUT2 control mode (>P, ON, OFF or PID)
  - <0802> > Control direction (>ON, OFF or ON)
  - <0803> > Control cycle (OUT1) (>1, m=1)
  - <0804> > Control cycle (OUT2) (>1, m=1)
  - <0805> > ON/OFF control hysteresis (OUT1) (>1, m=1)
  - <0806> > ON/OFF control hysteresis (OUT2) (>1, m=1)
  - <0807> > Emergency output (OUT1) (>0, A, m=1)
  - <0808> > Emergency output (OUT2) (>0, A, m=1)
  - <0809> > Control output high limit (>1300, m=1)
  - <0810> > Control output low limit (>0, m=1)
- SET group**
  - <0700> > Digital input mode (>OFF, OFF or ON)
  - <0701> > Operation mode after power on (>ON, OFF or ON)
  - <0702> > Parameter initialization (>ON, OFF or ON)
  - <0703> > Parameter set value lock (>0, 2)
  - <0704> > STOP/PAUSE task during operation (>OFF, OFF or ON)
- COMM group**
  - <0300> > Communication protocol (>P, M)
  - <0301> > Baud rate (>9.6, m=1)
  - <0302> > Parity bit (>N, M, m=1)
  - <0303> > Stop bit (>1, 1.5, 2)
  - <0304> > Data length (>8, 8 or 8)
  - <0305> > Address (>1, 1-99)
  - <0306> > Response delay time (>0.0-10)
  - <0307> > Response delay time (>0.0-10)
  - <0308> > Parameter set value lock (>0, 2)

**Basic Menu:** press and hold **MD** + **IK** for 1 sec.

- <0000> > Input type (>I, m=1)
- <0001> > Input bias (>0, m=1)
- <0002> > OUT1 control mode (>P, ON, OFF or PID)
- <0003> > OUT2 control mode (>P, ON, OFF or PID)
- <0004> > Control direction (>ON, OFF or ON)
- <0005> > Control cycle (OUT1) (>1, m=1)
- <0006> > Control cycle (OUT2) (>1, m=1)
- <0007> > Alarm 1 type (>1, 1-12)
- <0008> > Alarm 1 set value (>1370, m=1)
- <0009> > Alarm 1 deadband (>0, m=1)
- <0010> > Alarm 2 type (>1, 1-12)
- <0011> > Alarm 2 set value (>1370, m=1)
- <0012> > Alarm 2 deadband (>0, m=1)
- <0013> > Alarm 3 type (>1, 1-12)
- <0014> > Alarm 3 set value (>1370, m=1)
- <0015> > Alarm 3 deadband (>0, m=1)
- <0016> > Alarm 4 type (>1, 1-12)
- <0017> > Alarm 4 set value (>1370, m=1)
- <0018> > Alarm 4 deadband (>0, m=1)
- <0019> > Communication protocol (>P, M)
- <0020> > Communication speed (>9.6, m=1)
- <0021> > Parity bit (>N, M, m=1)
- <0022> > Stop bit (>1, 1.5, 2)
- <0023> > Data length (>8, 8 or 8)
- <0024> > Address (>1, 1-99)
- <0025> > Response delay time (>0.0-10)
- <0026> > Response delay time (>0.0-10)
- <0027> > Parameter set value lock (>0, 2)

**Simple menu:** press and hold **MD** for 1 sec.

- <0101> > Auto tuning (>ON, OFF or ON)
- <0102> > Alarm 1 setting (>1370, m=1)
- <0103> > Alarm 2 setting (>1370, m=1)
- <0104> > Alarm 3 setting (>1370, m=1)
- <0105> > Alarm 4 setting (>1370, m=1)
- <0106> > PID No.1 (>1, m=1)
- <0107> > PID No.2 (>1, m=1)
- <0108> > PID No.3 (>1, m=1)
- <0109> > PID No.4 (>1, m=1)
- <0110> > ON/OFF control hysteresis (OUT1) (>1, m=1)
- <0111> > ON/OFF control hysteresis (OUT2) (>1, m=1)
- <0112> > Proportional band (heating) (>1.0, 0.01-1.0)
- <0113> > Integral time (heating) (>1.0, 0.01-1.0)
- <0114> > Derivative time (heating) (>0.0, 0.01-1.0)
- <0115> > Manual reset (>1.0, 0.01-1.0)
- <0116> > Proportional band (cooling) (>1.0, 0.01-1.0)
- <0117> > Integral time (cooling) (>1.0, 0.01-1.0)
- <0118> > Derivative time (cooling) (>0.0, 0.01-1.0)
- <0119> > Heating cooling deadband (>1.0, 100.0-500.0)

**1: Refer to the User's Manual**  
Please visit our homepage ([www.hytex.com](http://www.hytex.com)) and refer to the user manual. In the archive.

**2: Key to move to operation mode screen**  
Press and hold **MD** in the parameter setting screen for 1 sec. to move to operation mode screen

**3: Move to group name display**  
Press **MD** during parameter display to move to group name (but during parameter display in n.PID, it moves to n.PID).

The parameter display differs depending on suffix code options and parameter settings.

✓ There is a bigger picture on the back page.

## ◆ Full mode configuration

This unit has 4 operation / editing modes (control operation (RUN), monitoring operation (STOP), control output display operation, set value (SV) edit mode), 3 menu modes (simple menu, full menu, basic menu) and 5 function keys (auto-tuning enable / disable, manual / automatic control output switching, lock enable / disable, RUN / STOP switch, alarm latch release). Each operation / edit mode, menu mode, and function keys are moved as shown below.

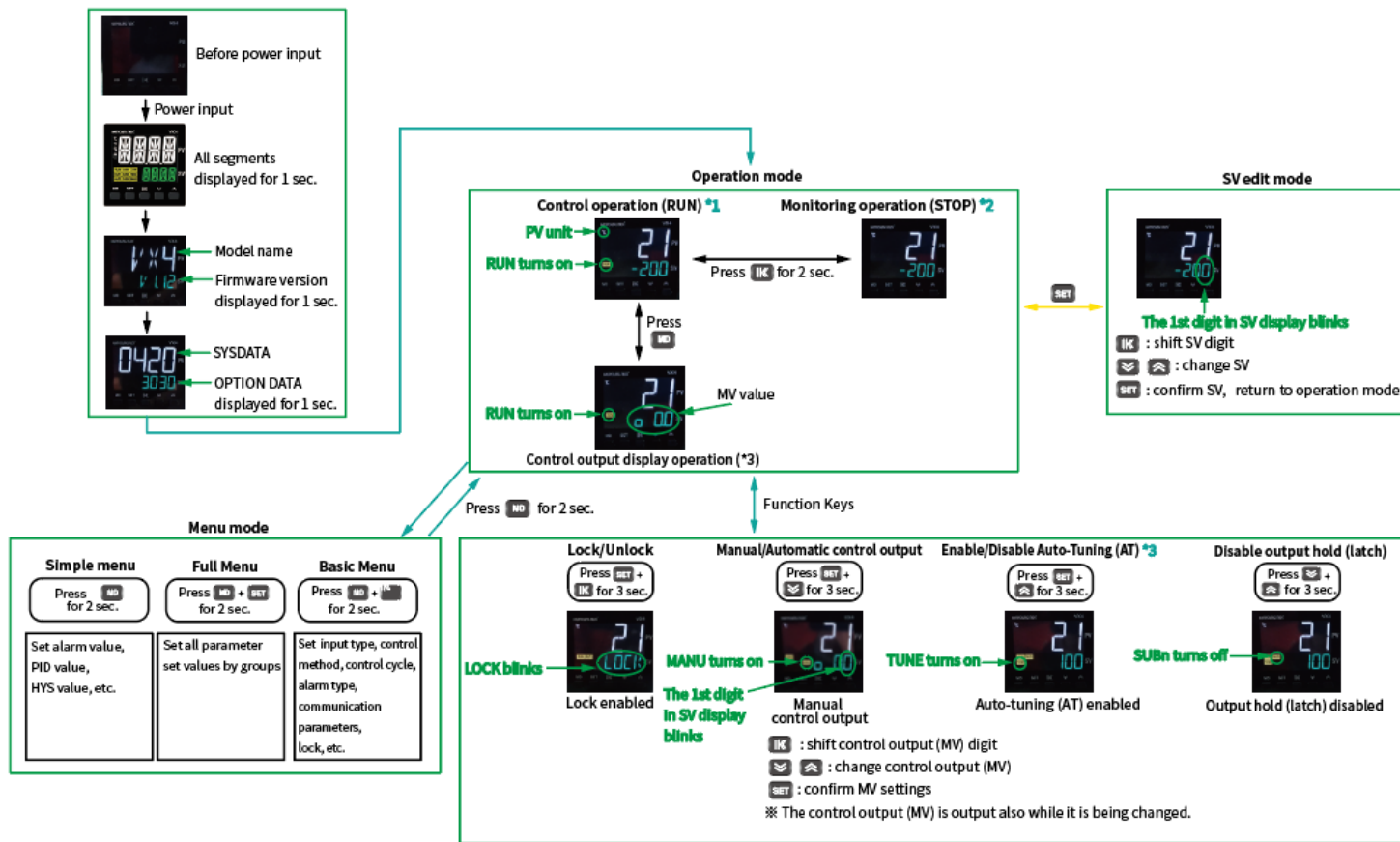

- \*1: Temperature control, Sub output (Alarm, LBA, HBA, etc.), communication and other functions are normal operations during Run. The Auto-tuning (AT) can be executed only during Run
- \*2: Sub output (Alarm etc.), communication and other functions except temperature control functions are normal operations during Stop. The Auto-tuning (AT) cannot be executed during Stop.
- \*3: The control output display allows the confirmation of the control output status currently operating. The Auto-tuning (AT) can be executed during control output display Run, and cannot be executed during control output display Stop.
- \*4: Alarm, LBA, HBA must be assigned to Sub n output (SUBn), and parameter output latch must be ON.

**Note:** If no key is pressed during 30 sec. In Menu mode, It returns to Run mode.

- ✓ How to switch between control operation (RUN) and monitoring operation (STOP)
  - In monitoring operation (STOP), press  for 2 seconds to switch to control operation (RUN).



- In the control operation (RUN), press  for 2 seconds to switch to monitoring operation (STOP).



- ✓ How to change the set value (SV) by editing
  - How to change set value (SV) Example) How to change from -200 °C to 100 °C
    1. In the operation (RUN) or monitoring (STOP) operation mode, press  to move to set value (SV) edit mode.



## Control (RUN) /Monitoring (STOP) operation modes



Shift to set value (SV) edit mode  
Press **SET**

## Set value (SV) edit mode



The 1st digit in SV display blinks

2. Change the set value (SV) to 100 with **⏪**, **⏩**, **⏴**.

### Set value (SV) edit mode



The 1st digit in SV display blinks

Shift set value (SV) digit position  
Press **IK**

### Set value (SV) edit mode



The 2nd digit in SV display blinks

Shift set value (SV) digit position  
Press **IK**

### Set value (SV) edit mode



The 3rd digit in SV display blinks

Change set value (SV)  
Press **⏩** or **⏴**

### Set value (SV) edit mode



The 3rd digit in SV display blinks

3. Save the set value (SV) and move to the control (RUN) or monitoring (STOP) operation mode with **SET**

### Set value (SV) edit mode

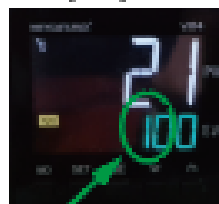

The 3rd digit in SV display blinks

Shift to set value (SV) save and operation mode  
Press **SET**

### Control (RUN) /Monitoring (STOP) operation modes



#### ※ Precautions

- If you do not press **SET** after changing the set value (SV) in set value (SV) edit mode, the set value (SV) cannot be saved in the device.
- If no key is pressed for 30 seconds in the set value (SV) edit mode, it returns to operation mode.

✓ How to shift control output display operation mode

- In control operation (RUN), press **MD** to switch to control output display operation.

**Control operation (RUN)**



Press **MD**

**Control output display operation**



**Control output value (MV)**

- In control output display operation, press **MD** to switch to control operation (RUN).

Classification	Setting to change
Suffix code	VX4-UMNA-A2C
Input	Thermocouple K type with decimal point (-100.0 ~ 500.0 °C) Bias : 0.0 °C (Default)
Output	PID control, reverse action Control cycle 30 sec.
Alarm	Alarm 1: Type = high deviation, Alarm value = 10.0 °C, deadband = 1.0 °C Alarm 1: Type = high absolute, Alarm value = 300.0 °C, deadband = 1.0 °C
Communication	Protocol: Modbus RTU Speed :19200 bps Parity bit : EVEN Stop bit : 1 bit Data length : 8 bit Address : 1 Response delay time: 0 msec

Other	Operation mode after power supply = RUN Lock Setting = None
-------	--

### Control output display operation



Control output value (MV)











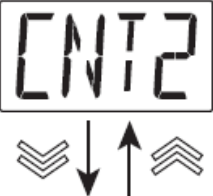





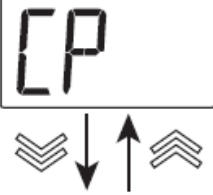













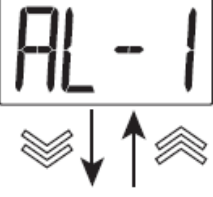





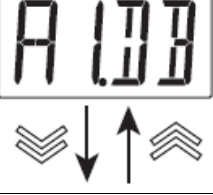

Press







### Control operation (RUN)





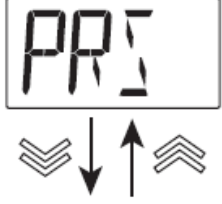

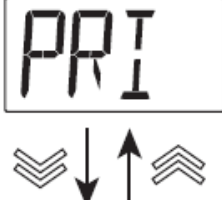
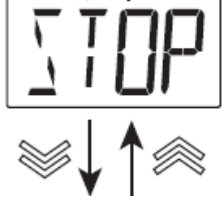
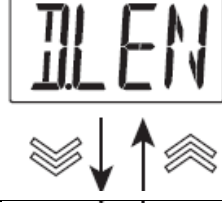



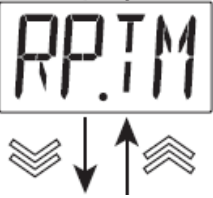







- ✓ Setting example with basic menu mode

	<p>In operation mode, press  +  for more than 1 second to enter basic menu (MMI and parameters)</p>
	<p>Press  to change parameters.          After you press  'K1' will be displayed.          After you press  it will shift to the next parameter after saving</p>
	<p>After you press  it will shift to the next parameter without changes (if set value is not '0.0', after pressing , use , ,  to set '0.0' and then press  to save)</p>
	<p>After you press  it will shift to the next parameter without changes (if set value is not 'PID', after pressing , use  to set 'PID' and then press  to save)</p>

	<p>This parameter is not displayed in VX4-UMNA-A2C</p>
	<p>After you press  it will shift to the next parameter without changes (if set value is not 'REV', after pressing , use  to set 'REV' and then press  to save)</p>
	<p>Press  to change parameters  After you press , ,  '30' will be displayed.  After you press  it will shift to the next parameter after saving</p>
	<p>This parameter is not displayed in VX4-UMNA-A2C</p>
	<p>After you press  it will shift to the next parameter without changes (If the set value is not '3', press , then use , ,  to set '3', then press  to save).</p>
	<p>Press  to change parameters  After you press , ,  '10' will be displayed.  After you press  it will shift to the next parameter after saving</p>
	<p>After you press  it will shift to the next parameter without changes (If the set value is not '1.0', press , then use , ,  to set '1.0', then press  to save).</p>
	<p>Press  to change parameters  After you press , ,  '1' will be displayed.  After you press  it will shift to the next parameter after saving</p>

	<p>Press <b>SET</b> to change parameters          After you press <b>  ◀</b>, <b>⏏</b>, <b>⏏</b> '300.0' will be displayed.          After you press <b>SET</b> it will shift to the next parameter after saving</p>
	<p>After you press <b>⏏</b> it will shift to the next parameter without changes          (If the set value is not '1.0', press <b>SET</b>, then use <b>  ◀</b>, <b>⏏</b>, <b>⏏</b> to set '1.0', then press <b>SET</b> to save).</p>
	<p>Press <b>SET</b> to change parameters          After you press <b>⏏</b>, <b>⏏</b> 'RTU' will be displayed.          After you press <b>SET</b> it will shift to the next parameter after saving</p>
	<p>Press <b>SET</b> to change parameters          After you press <b>⏏</b>, <b>⏏</b> '19.2'K will be displayed.          After you press <b>SET</b> it will shift to the next parameter after saving</p>
	<p>Press <b>SET</b> to change parameters          After you press <b>⏏</b>, <b>⏏</b> 'EVEN' will be displayed.          After you press <b>SET</b> it will shift to the next parameter after saving</p>
	<p>After you press <b>⏏</b> it will shift to the next parameter without changes          (if set value is not '1', after pressing <b>SET</b>, use <b>⏏</b>          to set '1' and then press <b>SET</b> to save)</p>
	<p>After you press <b>⏏</b> it will shift to the next parameter without changes          (if set value is not '8', after pressing <b>SET</b>, use <b>⏏</b>          to set '8' and then press <b>SET</b> to save)</p>
	<p>After you press <b>⏏</b> it will shift to the next parameter without changes          (if set value is not '1', after pressing <b>SET</b>, use <b>⏏</b>          to set '1' and then press <b>SET</b> to save)</p>

	<p>After you press  it will shift to the next parameter without changes (if set value is not '0', after pressing , use  to set '0' and then press  to save)</p>
	<p>After you press  it will shift to the next parameter without changes (If the set value is not 'RUN', press , then use ,  to set 'RUN', then press  to save).</p>
	<p>After you press  it will shift to the next parameter without changes (if set value is not '0', after pressing , use  to set '0' and then press  to save).</p>

◆ **G.SV (SV Group)**

Parameter	Setting range	Unit	Initial value	Display condition
SV.NO	1 ~ 4	-	1	-. Always displayed
SV-H	*3) FR-L ~ FR-H *4) SL-L ~ SL-H (however, SV-L < SV-H)	*2)	*3) FR.H *4) SL.H	-. Always displayed
SV-L			*3) FR.H *4) SL.H	
SV-1	SV-L ~ SV-H	*2)	SV-L	-. Always displayed
SV-2				
SV-3				
SV-4				

\*2) According to G.IN> UNIT

\*3) TC, RTD

\*4) DCA, DCV, DCmV

■ **SV.NO (SV Number)**

SV number can be set from 1 to 4, and it will be operated with selected SV.

There are different ways to select SV: by using SV.NO parameter, by DI input, and by REM selection. The priority order is DI input> REM> SV.NO.

The selected SV No. depends on the use of DI and REM.

When DI is not used, the SV no that is selected according to the SV.NO parameter is shown in the table below (when using REM, SV.NO selected in SV.NO parameter is ignored.)

REM	SV.NO			
	1	2	3	4
Not used	SV-1	SV-2	SV-3	SV-4
In use	REM	REM	REM	REM

When DI is used, the SV no. selected according to SV.NO selected by DI. is shown in the table below (when using DI, SV.NO selected in SV.NO parameter is ignored.)

REM	SV.NO selected by DI			
	1	2	3	4
Not used	SV-1	SV-2	SV-3	SV-4
In use	SV-1	SV-2	SV-3	REM

- SV-H (SV High Limit)
- SV-L (SV Low Limit)

The user can limit and prevent the setting of unintended SV with the high and low limit values of the SV setting.

The SV selections by SV.NO, DI, or REM are both limited.

The setting ranges of SV limit values are as follows, according to the type of input sensor.

TC, RTD :  $FR-L \leq SV-L < SV-H \leq FR-H$

DCA, DCV, DCmV :  $SL-L \leq SV-L < SV-H \leq SL-H$

- SV-1 (Set value 1)
- SV-2 (Set value 2)
- SV-3 (Set value 3)
- SV-4 (Set value 4)

SV-1, 2, 3 & 4 are the set values for controlling the device, which is greater than or equal to SV-L and less than or equal to SV-H. That is:  $SV-L \leq SV-1$  (or  $SV-2, 3, 4$ )  $\leq SV-H$ .



◆ G.CTL (Control Group)

Parameter	Setting range	Unit	Initial value	Display condition
AT.MD	STD, LOW	-	STD	-. G.OUT>CNT1 = PID or CNT2 = PID
AT	OFF, ON	-	OFF	-. G.OUT>CNT1 = PID or CNT2 = PID -. During RUN state
ARW	Auto, (50.0~200.0) %	%	50.0	-. G.OUT>CNT2 ≠ NONE
ALPA	0 ~ 100	-	50	-. G.OUT>CNT1 = PID or CNT2 = PID
1.PID	PID No 1 selection			-. G.OUT>CNT1 = PID or CNT2 = PID
1.P	*5) EUS (0.15~100.0) % *6) EUS (0.0~100.0) %	*2)	EUS 5.0 %	-. G.OUT>CNT1 = PID
1.I	OFF, 1~6000	Time (seconds)	240	
1.D	OFF, 1~6000	Time (seconds)	60	
1.MR	(-5.0~105.0) %	%	50.0	-. G.OUT>CNT1 = PID -. 1.I = OFF
1.Pc	EUS (0.0~100.0) %	*2)	EUS 5.0 %	-. G.OUT>CNT2 = PID
1.Ic	OFF, 1~6000	Time (sec.)	240	
1.Dc	OFF, 1~6000	Time (sec.)	60	
1.DB	(-100.0~50.0) %	%	3.0	-. G.OUT>CNT1 = PID or CNT2 = PID -. G.OUT>CNT2 ≠ NONE

2.PID	PID No 2 selection			-. G.OUT>CNT1 = PID or CNT2 = PID
2.P	*5) EUS (0.15~100.0) % *6) EUS (0.0~100.0) %	*2)	EUS 5.0 %	-. G.OUT>CNT1 = PID
2.I	OFF, 1~6000	Time (sec.)	240	
2.D	OFF, 1~6000	Time (sec.)	60	
2.MR	(-5.0~105.0) %	%	50.0	-. G.OUT>CNT1 = PID -. 2.I = OFF
2.Pc	EUS (0.0~100.0) %	*2)	EUS 5.0 %	-. G.OUT>CNT2 = PID
2.Ic	OFF, 1~6000	Time (sec.)	240	
2.Dc	OFF, 1~6000	Time (sec.)	60	
2.DB	-100.0 ~ 50.0	%	3.0	-. G.OUT>CNT1 = PID or CNT2 = PID -. G.OUT>CNT2 ≠ NONE
3.PID	PID No 3 selection			-. G.OUT>CNT1 = PID or CNT2 = PID
3.P	*5) EUS (0.15~100.0) % *6) EUS (0.0~100.0) %	*2)	EUS 5.0 %	-. G.OUT>CNT1 = PID
3.I	OFF, 1~6000	Time (sec.)	240	
3.D	OFF, 1~6000	Time (sec.)	60	
3.MR	(-5.0~105.0) %	%	50.0	-. G.OUT>CNT1 = PID -. 3.I = OFF
3.Pc	EUS (0.0~100.0) %	*2)	EUS 5.0 %	-. G.OUT>CNT2 = PID
3.Ic	OFF, 1~6000	Time (sec.)	240	

3.Dc	OFF, 1~6000	Time (sec.)	60	
3.DB	-100.0 ~ 50.0	%	3.0	-. G.OUT>CNT1 = PID or CNT2 = PID -. G.OUT>CNT2 ≠ NONE
4.PID	PID No 4 selection			-. G.OUT>CNT1 = PID or CNT2 = PID
4.P	*5) EUS (0.15~100.0) % *6) EUS (0.0~100.0) %	*2)	EUS 5.0 %	
4.I	OFF, 1~6000	Time (sec.)	240	-. G.OUT>CNT1 = PID
4.D	OFF, 1~6000	Time (sec.)	60	
4.MR	(-5.0~105.0) %	%	50.0	-. G.OUT>CNT1 = PID -. 4.I = OFF
4.Pc	EUS (0.0~100.0) %	*2)	EUS 5.0%	
4.Ic	OFF, 1~6000	Time (sec.)	240	-. G.OUT>CNT2 = PID
4.Dc	OFF, 1~6000	Time (sec.)	60	
4.DB	-100.0 ~ 50.0	%	3.0	-. G.OUT>CNT1 = PID or CNT2 = PID -. G.OUT>CNT2 ≠ NONE
RM.UP	OFF, EUS (0.0 %+1Digit)~100.0 %	*2)	OFF	-. Always displayed
UP.TM	00.01 ~ 99.59	hh:mm	01.00	-. G.SV>RM.UP ≠ OFF
RM.DW	OFF, EUS (0.0 %+1Digit)~100.0 %	*2)	OFF	-. Always displayed
DW.TM	00:01 ~ 99:59	hh:mm	01.00	-. G.SV>RM.DW ≠ OFF

\*2) According to G.IN> UNIT

\*5) heating type

\*6) heating/cooling type

#### ◆ AT (Auto-Tuning)

The auto-tuning function automatically measures, computes the control system characteristics, and automatically sets the optimum proportional band (P), integral time (I), and derivative time(D) constants.

When auto-tuning starts, the control output is changed temporarily to ON/OFF control and the optimum PID constants are computed and set from those response data.

This method is called limit cycle.

The time required for AT depends greatly on the control target.

If AT is not terminated even if 24 hours have elapsed since AT started, AT is automatically canceled (terminated).

If the AT exceeds the maximum elapsed time, the control output will generate an emergency output, the '[T]' icon will keep blinking, and 'AT.E' will be displayed on the PV window.

The SV value used for AT is used as the SV value of the number set for SV.NO and when the remote input (REM) is used, the remote input value is used as SV.

#### ■ AT.MD (Auto-tuning mode)

There are two types of auto-tuning: standard type and low PV type.

- Standard type auto-tuning: auto-tuning based on set value (SV)
- Low PV type auto-tuning: auto-tuning based on a value 10% lower than set value (SV)

When low PV type auto-tuning is performed, the set SV is displayed on the device, and the actual operation executes the auto-tuning at SV-10%.

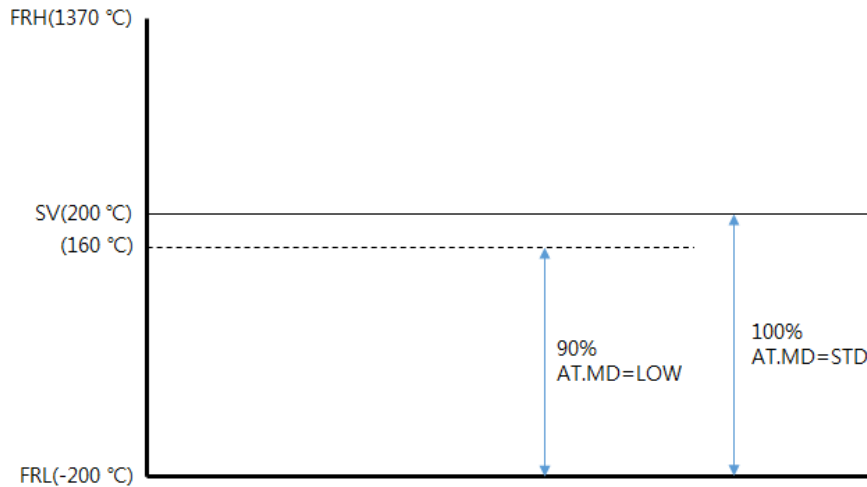

For example, if the SV is set to 200 ° C with TC K type sensor, and the low-PV type auto-tuning is performed, the SV displayed on the device is 200 ° C and the actual operation executes the auto-tuning at 160 ° C.

The calculation formula is as follows.

$$\text{SV of low PV type auto-tuning} = (\text{SV} - \text{FRL}) \times 0.9 - \text{FRL} = (200 - (-200)) \times 0.9 - \text{FRL} = 160$$

#### ■ AT (Auto-tuning)

If AT is set to ON, or if 'SET' key and 'UP' key are pressed and held for more than 3 seconds in the operating state, auto-tuning starts (however, the device must be in the RUN state).

The AT sequence is as follows:

- 가. Select the SV number to execute AT (SV.NO) (SV.NO)
- 나. Set the corresponding SV value to the corresponding SV.NO.
- 다. Select from standard or low PV type in AT.MD.
- 라. Check if VX is in the RUN state (if it is not in RUN state, put it in RUN state).
- 마. AT execution methods:
  - A. set AT parameter to ON in G.AT group
  - B. Press and hold 'SET' key and 'UP' key for more than 3 seconds in operating state.  
[When AT is executed, the AT display part in the front display window turns on]
  
- A. set AT parameter to OFF in G.AT group
- B. Press and hold 'MODE' key and 'UP' key for more than 3 seconds in operating state.

[When AT is terminated, the AT display part in the front display window turns off]

㉞. AT execution (completion, cancel or forced termination after maximum time has elapsed)

If AT is completed normally, 'P', 'I', 'D' values are reset to the same PID number as SV.NO. However, 'P', 'I', and 'D' values are reset to PID No.4 when set as remote input .

The 'P', 'I', 'D' values are not changed if AT is cancelled or forcibly terminated during AT.

#### ◆ PID (Proportional Band, Integral Time, Derivative Time)

##### ■ ARW (Anti reset wind-up)

When the control output value reaches the limit value (OLH, OLL), it executes the ARW operation to prevent overintegration.

##### ■ ALPA (Alpha)

The response in a typical closed loop control system can be broadly divided into response to set value change and response to disturbance, and the normal PID (one-degree-of-freedom) algorithm has the limitation, that it can only optimize one response for these two responses. To overcome this limitation, with the application of the two-degree-of-freedom PID algorithm, you can optimize the response to the set value change and obtain an appropriate response to disturbances.

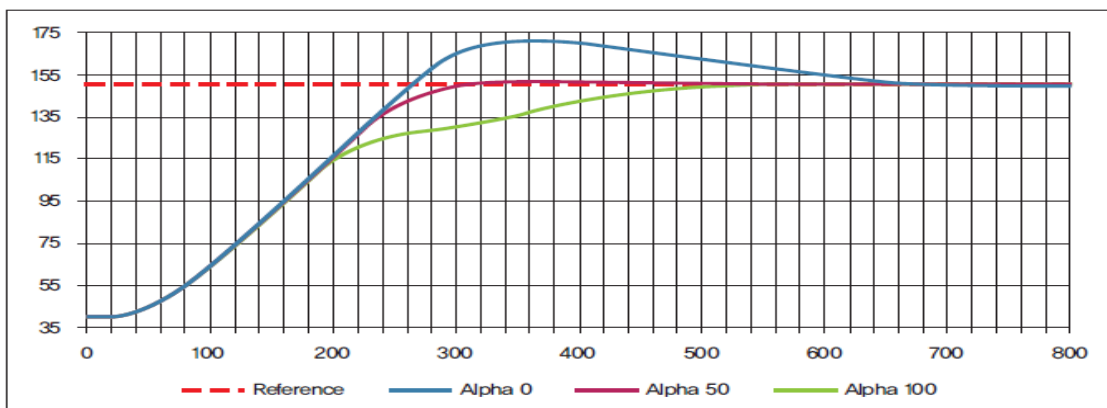

[Picture. Control function according to Alpha ]

The ALPHA parameter is used to adjust the response characteristics to the set value (SV) changes.

If ALPHA = 0%, it is the same as the normal PID control.

If ALPHA = 100%, it may take a long time to reach a normal state.

When the n.I parameter is set to 0 (OFF) in the G.CTL group, the ALPA value will be set to 0 internally in the program, the ALPA parameter will not be visible in G.GTL, and the MR parameter will be visible.

If the n.I parameter is not set to 0 (OFF) in the G.CTL group, the ALPA value will be reset internally to the previously set ALPA value, the MR parameter will not be visible in G.GTL, and the ALPA parameter will be visible.

#### ■ n.PID (PID No n)

If N.PID is selected, the PID parameter of the corresponding PID number is displayed.

n.P, n.I, n.D values are heating PID parameters, and n.Pc, n.Ic, n.Dc are cooling PID parameters.

The cooling parameters are displayed when G.OUT> CNT2 is not NONE in products with OUT2 option.

The PID coefficients are automatically set when the AT is completed, and can be set directly if the user already knows them. You can also modify the PID coefficients that are set automatically after AT.

#### ◆ RAMP

When the ramp function is used, the SV changes with a gradient to increase or decrease during the set time.

Therefore, in order to set the ramp, the unit time and SV change amount per unit time should be set.

The RAMP Up or RAMP Down functions are applied when the SV value is changed when changing from STOP to RUN or during RUN. . When changing from STOP to RUN, SV starts from PV, and when SV is changed, it starts from current SV.

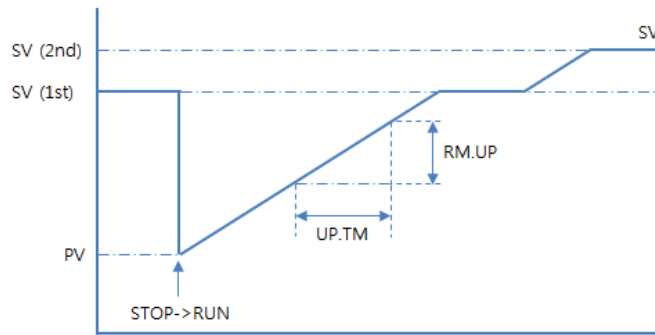

[Picture. RAMP UP example]

- RM.UP (Ramp Up)

Sets the SV variation amount per unit time (UP.TM).

- UP.TM (Ramp Up Time)

Sets unit time for SV variation amount (RM.UP).

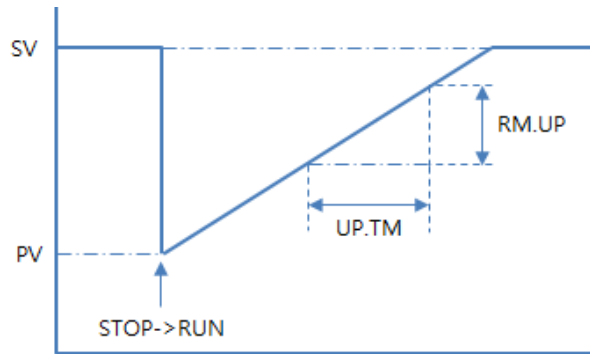

[Picture. Ramp Up ]

For example, if RM.UP is 60 ° C and UP.TM is 1 minute, the SV value has a Ramp Up of 1.0 ° C per second.

- RM.DW (Ramp Down)

Sets the SV variation amount per unit time (DW.TM).

- DW.TM (Ramp Down Time)

Sets the unit time for SV variation amount (RM.DW).



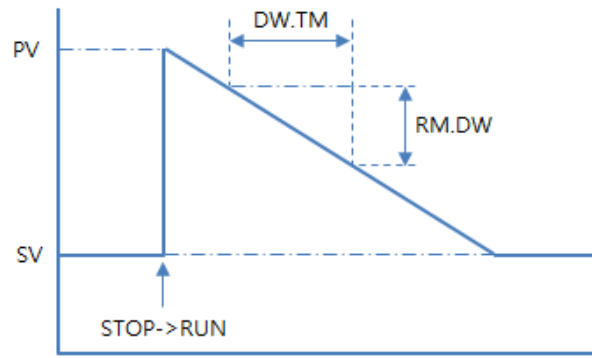

[Picture. RAMP Down]

For example, if RM.DW is 60 ° C and DW.TM is 1 minute, the SV value has a Ramp Down of 1.0 ° C per second.

◆ G.ALM (Alarm Group)

Parameter	Setting range	Unit	Initial value	Display condition
A1.TY	0 ~ 13	-	3	- . G.SUB> SUBx = ALM1
AL-1	Absolute : EU (0.0~100.0) % Deviation : EUS (0.0~100.0) %	*2)	EUS 100.0 %	- . G.SUB> SUBx = ALM1 - . G.ALM> A1.TY ≠ OFF (0)
	A1.DB			
A1.LS	RST, SET	-	RST	- . G.SUB> SUBx = ALM1 - . G.SUB> A1.LT = ON - . G.ALM> A1.TY ≠ OFF (0)
A2.TY	0 ~ 13	-	10	- . G.SUB> SUBx = ALM2
AL-2	Absolute : EU (0.0~100.0) % Deviation : EUS (0.0~100.0) %	*2)	EUS 100.0 %	- . G.SUB> SUBx = ALM2 - . G.ALM> A2.TY ≠ OFF (0)
	A2.DB			
A2.LS	RST, SET	-	RST	- . G.SUB> SUBx = ALM2 - . G.SUB> A2.LT = ON - . G.ALM> A2.TY ≠ OFF (0)
A3.TY	0 ~ 13	-	1	- . G.SUB> SUBx = ALM3
AL-3	Absolute : EU (0.0~100.0) % Deviation : EUS (0.0~100.0) %	*2)	EU 100.0 %	- . G.SUB> SUBx = ALM3 - . G.ALM> A3.TY ≠ OFF (0)
	A3.DB			
A3.LS	RST, SET	-	RST	- . G.SUB> SUBx = ALM3 - . G.SUB> A3.LT = ON - . G.ALM> A3.TY ≠ OFF (0)

A4.TY	0 ~ 13	-	2	- . G.SUB> SUBx = ALM4
AL-4	Absolute : EU (0.0~100.0) % Deviation : EUS (0.0~100.0) %	*2)	EU 0.0 %	- . G.SUB> SUBx = ALM4 - . G.ALM> A4.TY ≠ OFF (0)
A4.DB	EUS (0.0~100.0) %	*2)	1.0 °C	
A4.LS	RST, SET	-	RST	- . G.SUB> SUBx = ALM4 - . G.SUB> A4.LT = ON - . G.ALM> A4.TY ≠ OFF (0)
LB.TM	0 ~ 7200	Time (sec.)	480	
LB.SV	EUS (0.0~5.0) %	*2)	EUS 0.15 %	- . G.SUB> SUBx = LBA
LB.DB	EUS (0.0 % + 1 digit) ~ 5.0 %	*2)	EUS 0.15 %	
LB.LS	RST, SET	-	RST	- . G.SUB> SUBx = LBA - . G.SUB> LB.LT = ON
HB-1	OFF, (1.0 ~ 50.0) A	Current (A)	OFF	- . G.SUB> SUBx = HBA
H1.DB	(0.1 ~ 50.0) A		0.5	- . G.SUB> SUBx = HBA
CT1.M	(0.0 ~ 55.0) A		-	- . G.ALM> HB-1 ≠ OFF
HB-2	OFF, (1.0 ~ 50.0) A		OFF	- . G.SUB> SUBx = HBA - . G.SUB> HB2.E = ON
H2.DB	(0.1 ~ 50.0) A		0.5	- . G.SUB> SUBx = HBA
CT2.M	(0.0 ~ 55.0) A		-	- . G.SUB> HB2.E = ON - . G.ALM> HB-2 ≠ OFF
HB.LS	RST, SET	-	RST	- . G.SUB> SUBx = HBA - . G.SUB> HB.LT = ON - . G.ALM> HB-1 ≠ OFF

\* 2) According to G.IN> UNIT

Code	ALARM NAME	Absolute alarm	Deviation alarm
0	Alarm Off		
1	High Absolute	○	
2	Low Absolute	○	
3	High Deviation		○
4	Low Deviation		○
5	High-Low Deviation		○
6	High-Low Range		○
7	High absolute with standby sequence	○	
8	Low absolute with standby sequence	○	
9	High deviation with standby sequence		○
10	Low deviation with standby sequence		○
11	High-Low deviation with standby sequence		○
12	High-Low range with standby sequence		○
13	Sensor error	○	

[Alarm type and code]

Code	Alarm type	Alarm operation	Absolute alarm	Deviation alarm
0	Alarm off			
1 (7)	High absolute High absolute with standby sequence		O	
2 (8)	Low absolute Low absolute with standby sequence		O	
3 (9)	High Deviation High Deviation with standby sequence			O
4 (10)	Low deviation Low deviation with standby sequence			O
5 (11)	High-Low Deviation High-Low Deviation with standby sequence			O
6 (12)	High-Low range High-Low range with standby sequence			O
13	Sensor error	Burn-out	O	

※ Gray part: Ax.DB,

△: SV set value,

▲: AL-x set value. The number indicated in parenthesis () has standby sequence

※ x indicates alarm number 1 ~ 4

[Alarm operation]

■ An.TY (Alarm No.n Type)

With An.TY, you can choose between 'Alarm off' and 13 alarm types listed in the 'Alarm type and code' table.

Each type is divided into absolute alarm and deviation alarm, and the setting range is displayed differently when AL-n is set.

'n' indicates alarm numbers 1 ~ 4. For alarm operation, please refer to the 'alarm operation' part.

#### ■ AL-n (Alarm No.x Value)

AL-x is the alarm setting value. When it is set as absolute alarm, the setting range is EU (0.0 ~ 100.0)%.

When it is set as deviation alarm, the setting range is EUS (0.0 ~ 100.0)%.

For example, when TC K type sensor is set and the alarm type is set to high absolute (alarm code= 1), the setting range of AL-x is -200 °C ~ 1,370 °C. When the alarm type is set to high deviation (alarm code= 3), the setting range of AL-x is 0.0 °C ~ 1,570.0 °C.

#### ■ An.DB (Alarm No.x Dead Band)

Ax.DB is the dead band to disable the alarm. An.DB setting range is set to EUS (0.0 ~ 100.0)% regardless of absolute alarm and deviation alarm.

The picture below 'alarm operation example (1)' shows an example of high absolute alarm of alarm number '1'.

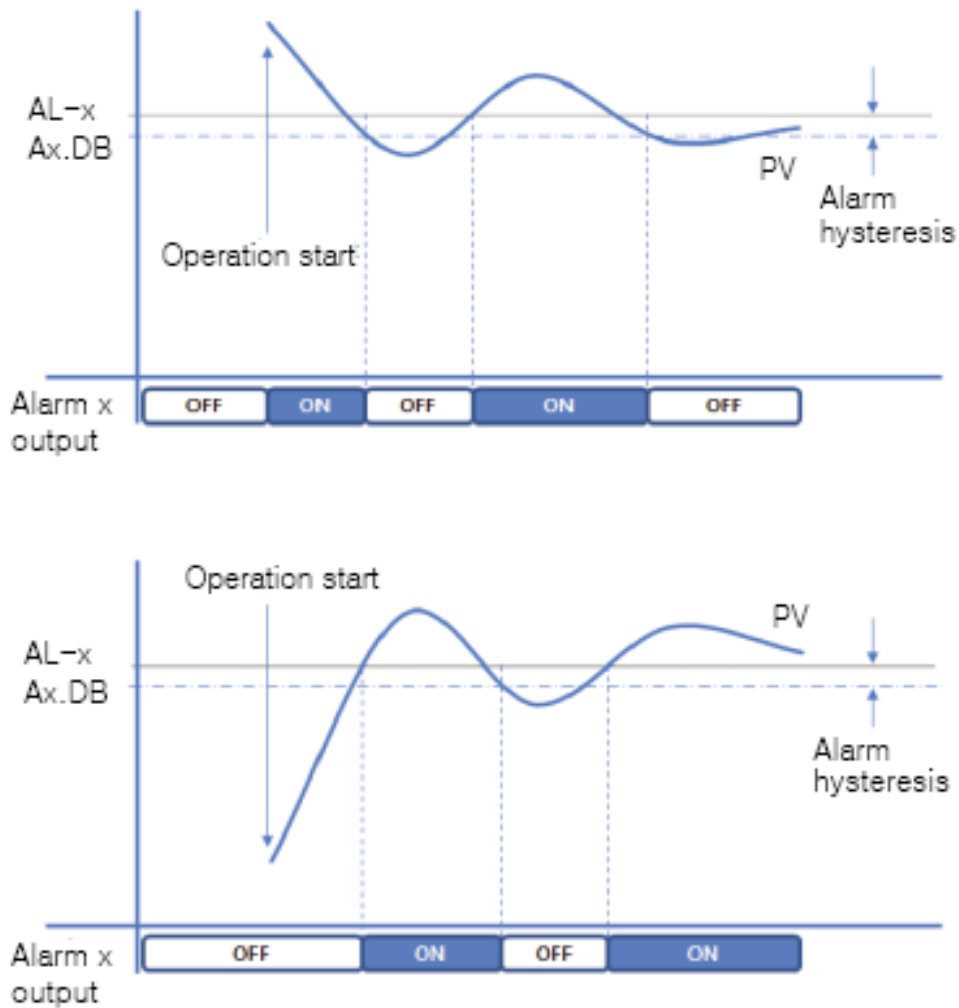

[Picture. [Alarm operation example (1)]

The picture below 'alarm operation example (2)' shows an example of high absolute alarm with standby sequence of alarm number '7'. In order not to generate the alarm at the start of operation, select the alarm setting number with the standby sequence.

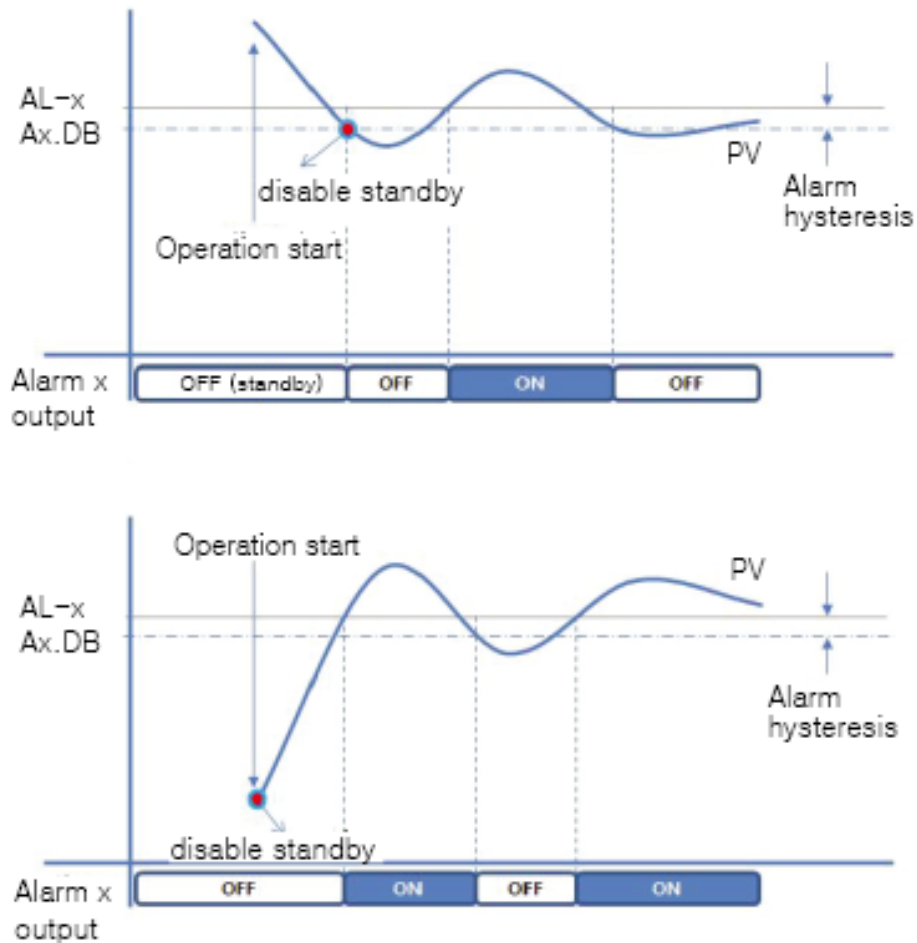

[Picture. Alarm operation example (2)]

The operation of alarms with standby sequence is as follows: the first alarm ON condition is ignored when the alarm ON condition is satisfied at the time of setting change (such as power ON, change from STOP to RUN, SV change, alarm setting change). An alarm is triggered for an alarm ON condition that occurs after the alarm release condition has been set.

- Power OFF -> Power ON
- STOP -> RUN
- SV value change
- Alarm setting change

■ An.LS (Alarm No.x Latch Status)

An.LS is the alarm output latch function and can be used when G.SUB> A1.LT is set to ON.



If G.SUB> A1.LT is OFF, the alarm is automatically set to 'SET' or 'RST' (Reset) as shown in 'alarm operation example (1) or example (2)' above. However, to release the alarm when G.SUB> A1.LT is set to ON, the user must change Ax.LS to 'RST' after the alarm release condition is reached.

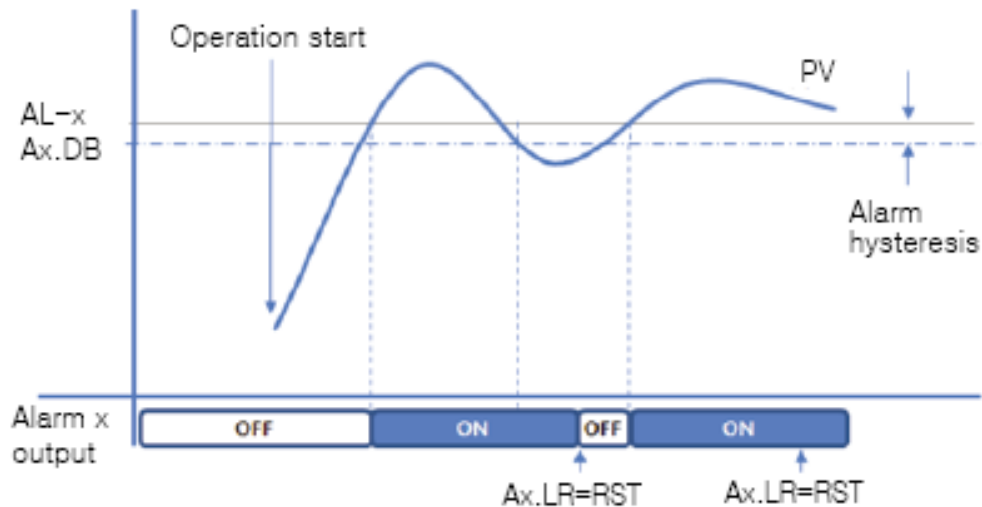

[Picture. Example of alarm operation when the latch function is activated]

If no alarm occurs, An.LS is in 'RST' state, and if alarm occurs, it is in 'SET' state. However, even if the alarm condition is released, the alarm condition is held and the alarm output is also generated. Therefore, to release the alarm, you must set An.LS to RST (while the alarm condition is released).

✓ How to release An.LS in latch state

When An.LS is set to 'SET', it can be released by selecting one of the following methods under the alarm release condition.

In G.ALM, change the An.LS parameter to 'RST'.

With DI4 option, An.LS is set to 'RST' when DI4 is turned ON.

Press Up or Down buttons on SV or MV display windows, in order to set An.LS to 'RST'. (cannot be used in SV setting window or MV setting window).

◆ LBA : Loop Break Alarm)

When the control output value by PID (or ON / OFF) operation reaches 0% or 100%, compares the variation amount of the deviation (SV-PV) with each set time of LB.TM, detects heater breaks, wiring errors, temperature sensor breaks and short circuit, output circuit abnormalities, etc. You can also set the LBA deadband (LB.DB) to avoid being affected by normal control loops.

When the control output value is 100% in the reverse action (heating control), the LBA output turns ON when the temperature does not rise above the LB.SV value within the LB.TM set time. Also, when the control output value is 0%, the LBA output turns ON when the temperature does not fall above the LB.SV value within the LB.TM setting time.

When the control output value is 100% in the direct action (cooling control), the LBA output turns ON when the temperature does not fall above the LB.SV value within the LB.TM set time. Also, when the control output value is 0 %, the LBA output turns ON when the temperature does not rise above the LB.SV value within the LB.TM set time.

In heating / cooling control, it operates only in reverse action.

- ✓ LBA is automatically released under the following conditions:
  - When control is in the STOP state
  - During Auto Tuning
  - When the deviation (SV-PV) is in the LB.DB range
  - When LBA is not set on sub output

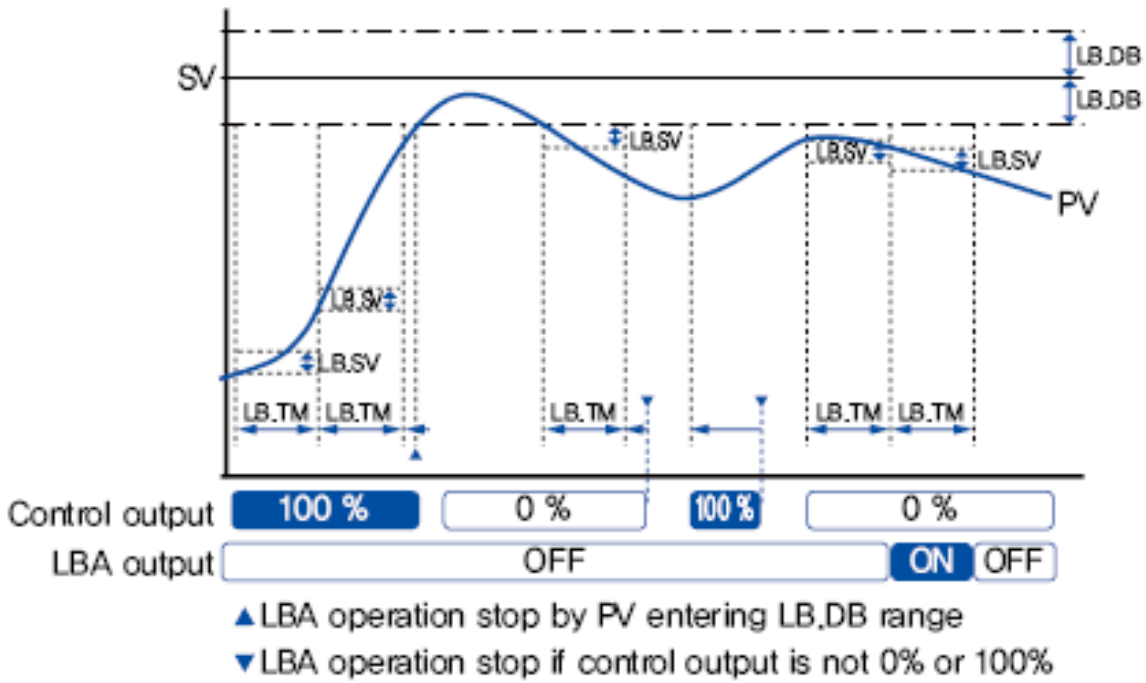

[Picture. LBA operation example]

■ LB.TM (Loop Break Alarm Time)

The loop break detection time is usually set to about twice the value of PID coefficient 1. When auto-tuning is executed, the LB.TM value is automatically set to twice the LB.TM 1 value.

However, when ON / OFF control is used, LB.TM is not set automatically, so it must be input manually by the user.

■ LB.SV (Loop Break Alarm SV)

When the control output reaches 100% or 0%, an alarm is generated if the change of the temperature deviation after LB.TM time does not change by more than the loop break alarm SV(LB.SV).

■ LB.DB (Loop Break Alarm Dead Band)

To prevent malfunctions of the loop break alarm during normal control, set the loop break alarm dead band. If PV enters the  $SV \pm LB.DB$  area, the loop break detection is not executed and the generated loop break alarm is also disabled.

That is, LBA will only work if PV is less than  $SV-LB.DB$  or if PV is greater than  $SV + LB.DB$ .

## ■ LB.LS (Loop Break Alarm Latch Status)

LB.LS is a Latch function of LBA output and can be used when G.SUB> LB.LT is set to ON. If there is no alarm, LB.LS is on RST state. If an alarm is generated, it is on SET state. However, even if the alarm condition is released, the alarm condition is maintained and the alarm output is also generated. Therefore, to release the alarm, you must set LB.LS to RST (while the alarm condition is released).

### ✓ How to release LB.LS in latch state

When LB.LS is set to 'SET', it can be released by selecting one of the following methods under the alarm release condition.

1. In G.ALM, change the LB.LS parameter to 'RST'.
2. With DI4 option, LB.LS is set to 'RST' when DI4 is turned ON.
3. Press Up or Down buttons on SV or MV display windows, in order to set LB.LS to 'RST'. (can not be used in SV setting window or MV setting window).

## ◆ HBA : Heater Break Alarm)

The HBA measures the current of the current detector (CT) connected to the heater (load) side, detects that the connected heater is not in a normal state, and generates an alarm.

The HBA can be used when at least one HBA is selected from the sub outputs.

- - Detects heater breaks and generates alarm immediately.
- - Please use the Hanyoung Nux specified current detector (CT)
- - It can not be used when controlling by phase angle control method using thyristors (SCR output)

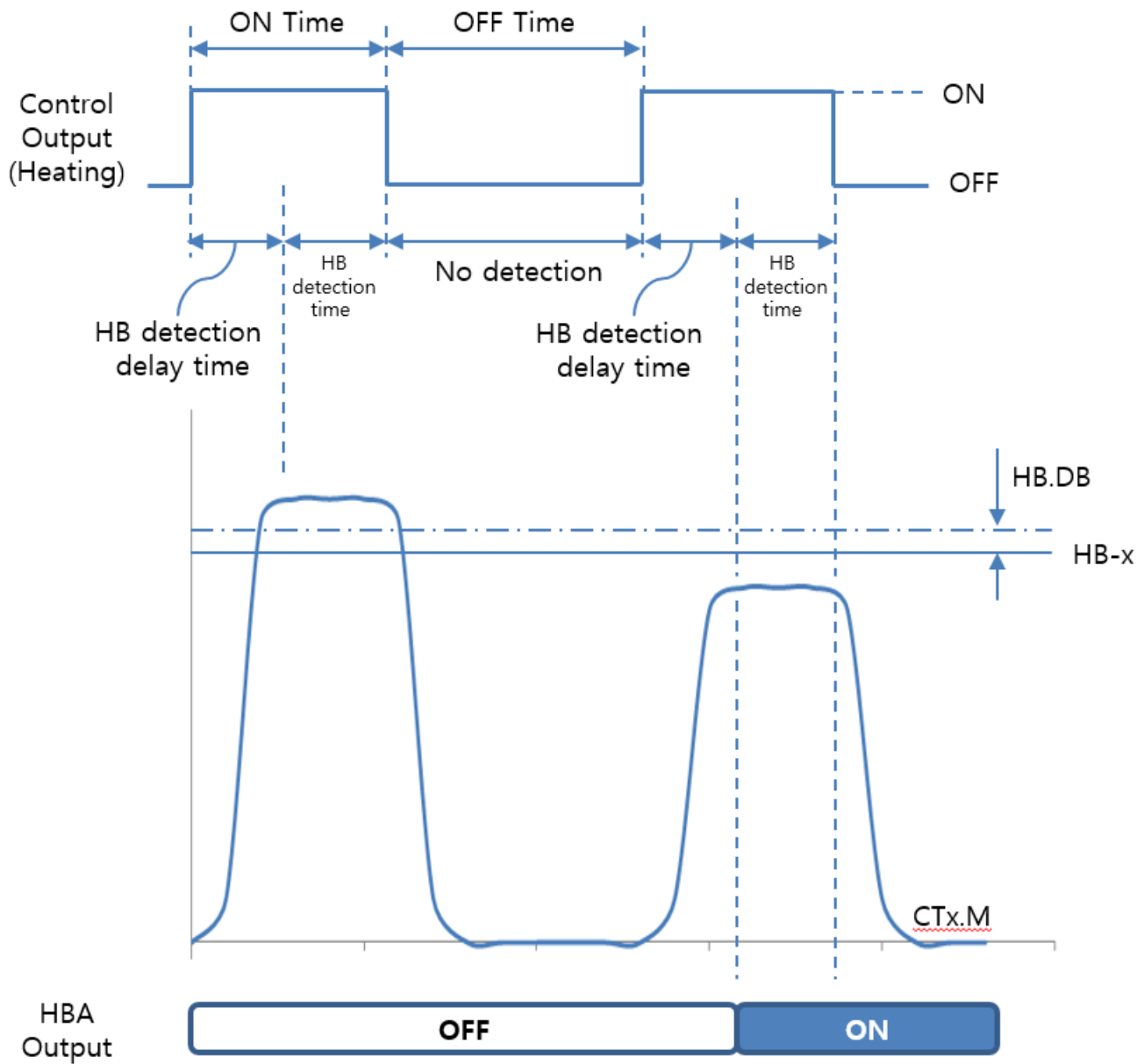

[Picture. HBA detection example]

As shown in the above picture, the current value is monitored until the control output turns off from after the HB detection delay time, after the heating control output turns ON. An alarm is generated when the heater is considered abnormal.

The generated alarm is held during the control output period time including the control output OFF time, and remains OFF until the control output turns ON and the HB detection time goes to normal range.

The HB detection delay time is about 500 ms to reach 95% or more of the actual input current.

Therefore, according to the control output period, the HB detection can be performed only when the minimum control output amount that can detect HB is exceeded.

Control output period (sec).	HB detection delay time (msec)	Minimum output amount (%) for HB detection
1	500 + 25 = 525	52.5
2		26.3
3		17.5
4		13.1
5		10.5
10		5.3
15		3.5
20		2.6
25		2.1
30		1.8

※ The control output period is the set value of the CP parameter in G.OUT.

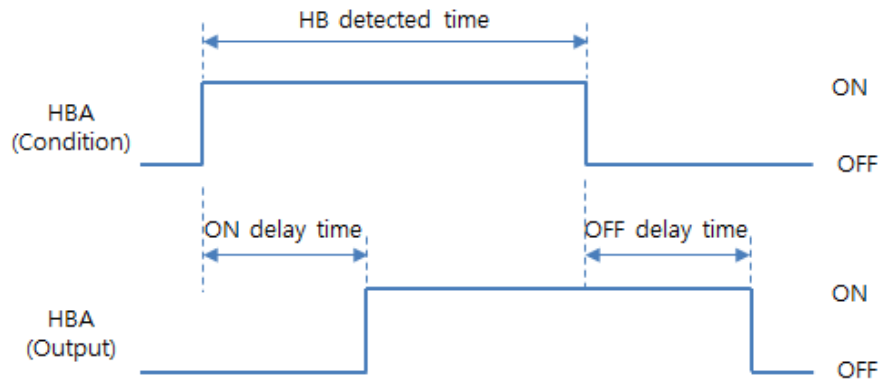

If HBA ON delay time is not set when an alarm condition occurs, the alarm output turns on immediately. If HBA ON delay time is set, alarm output turns on after delay time. Also, if the HBA OFF delay time is not set when the alarm condition is released, the alarm output turns off immediately. If HBA OFF delay time is set, the alarm output is OFF after the delay time.

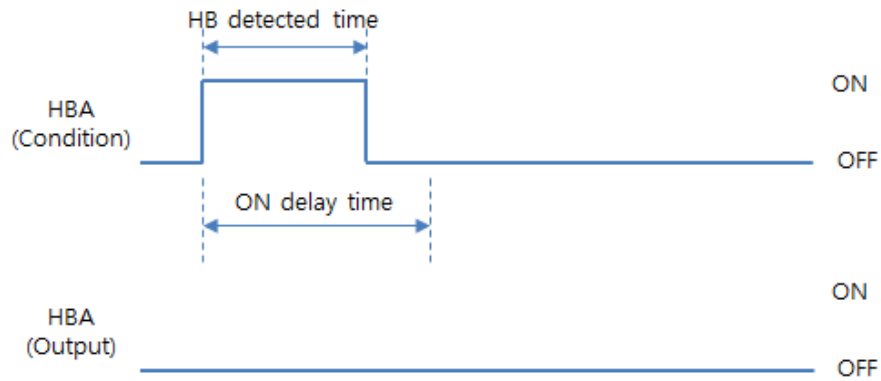

However, if HB detection time is shorter than HBA ON delay time, the alarm is not generated.

Normal or abnormal alarms may be generated depending on ON / OFF delay time during alarm generation and release.

When an alarm is generated, the alarm is normally output after ON delay time, when it is not during OFF delay.

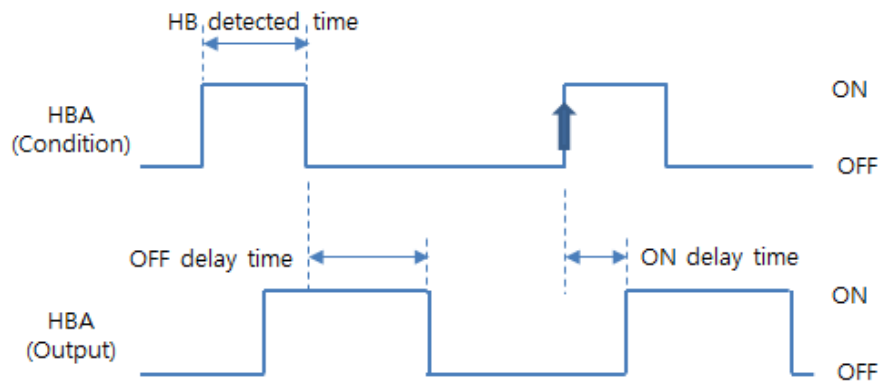

[Picture. When an alarm is generated, if it is not during OFF Delay (normal)]

When an alarm is released, the alarm is normally released after OFF delay time, when it is not during ON delay

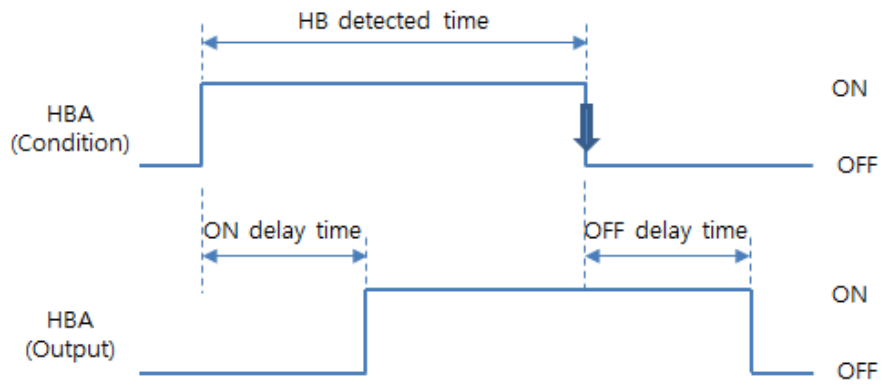

[Picture. When an alarm is released, if it is not during ON Delay (normal)]

When an alarm is generated, the alarm is output and not released, when it is during OFF delay.

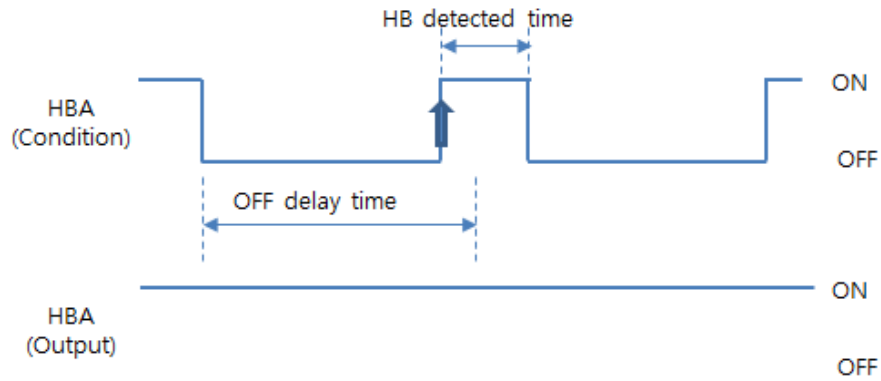

[Picture. When alarm is set, if it is during OFF Delay (abnormal output ON)]

When an alarm is released, the alarm is not output, when it is during ON delay.

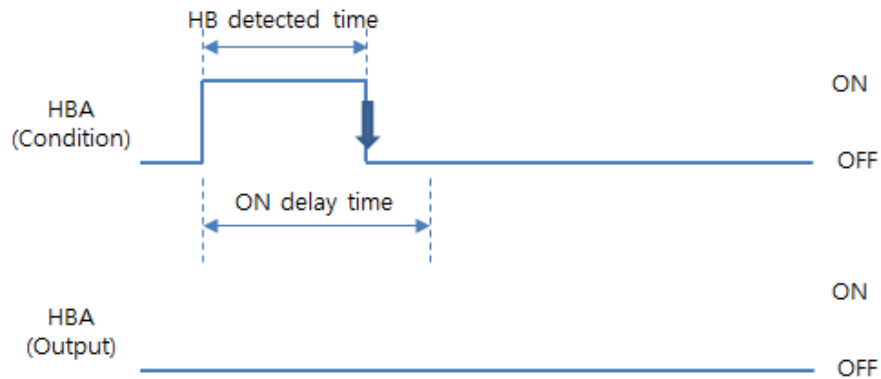

[Picture. When alarm is disabled, if it is during ON Delay (abnormal output OFF)]



When the latch function is not used, the generated alarm is OFF when the control output amount is 0% or less than the HB detection delay time.

An alarm is generated when the current measured during the HB detection time is less than the set current value ( $CT_n.M < HB-n$ ), and is disabled when it is more than the deadband area ( $CT_x.M > (HB-n + HB.DB)$ ).

■ HB-n (Heater Break No.n Current Value)

An alarm is generated when the current value, detected when the heating side control output is generated, is less than HB-n value.

■ HB.DB (Heater Break No.x Dead Band)

When HB-x or below current value is detected and an alarm is generated, the alarm will be released by detecting more than HB.DB value.

Single-Phase wiring example

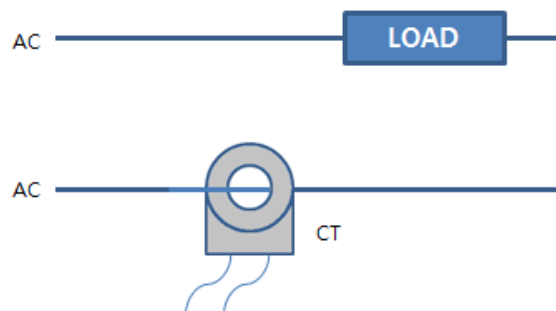

## Three-Phase wiring example

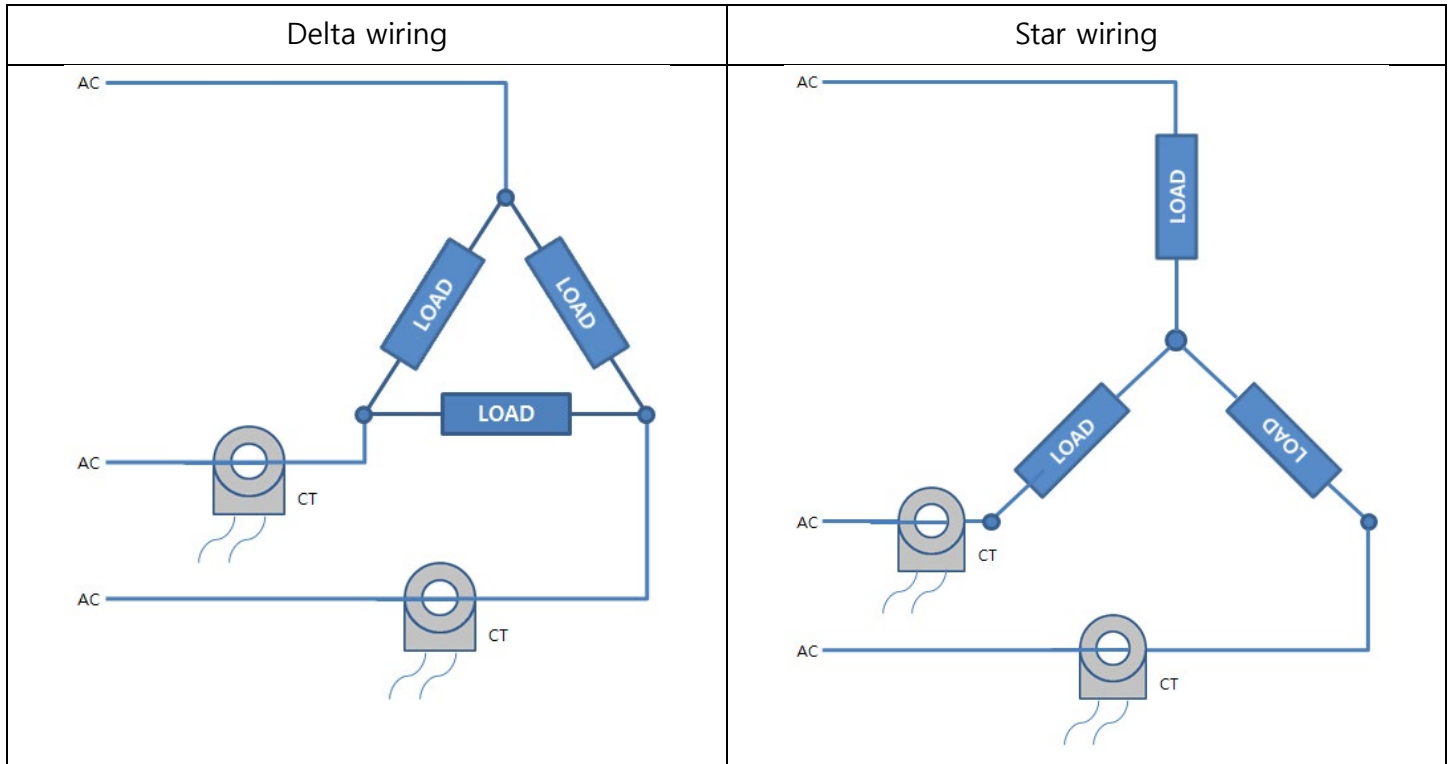

- CTn.M (CT No.n Monitoring)

The value of input CT current is monitored and displayed.

■ HB.LS (Heater Break Alarm Latch Status)

The HBA alarm also has a latch function that can be used when G.SUB> HB.LT is ON.

If an alarm set on HB1 or HB2 is generated, the settings of HB.LS will change from RST to SET.

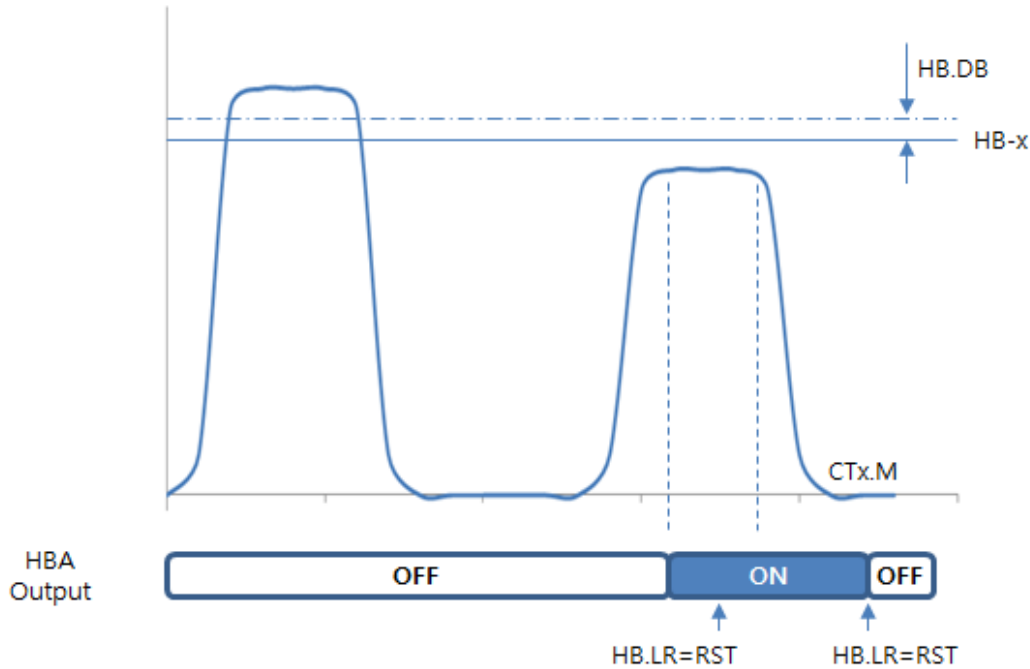

[Picture. HBA Latch Release]

At this time, the alarm is held until the user changes HB.LS to RST while the HBA alarm is released.

✓ How to release HB.LS latch state

When HB.LS is set to 'SET', it can be released by selecting one of the following methods under the alarm release condition.

1. In G.ALM, change the HB.LS parameter to 'RST'.
2. With DI4 option, HB.LS is set to 'RST' when DI4 is turned ON.
3. Press Up or Down buttons on SV or MV display windows, in order to set HB.LS to 'RST'. (can not be used in SV setting window or MV setting window).

◆ G.TRS (Transfer & Remote Group)

Parameter	Setting range	Unit	Initial value	Display condition
RET.T	PV, SV, MV	-	PV	-. For products with the RET option
T-SH	*3) FR.L ~ FR.H	*2)	EU 100 %	-. For products with the RET option - G.TRS>TR.MD = PV or SV
T-SL	*4) SL.L ~ SL.H (however, TR-L < TR-H)		EU 0 %	
T-AH	PV, SV : EUS (-5.0~5.0) % MV : EU (95.0~105.0) %	PV, SV : °C MV : %	PV, SV : EUS 0 % MV : EU 100 %	-. For products with the RET option
T-AL	PV, SV : EUS (-5.0~5.0) % MV : EU (-5.0~5.0) %		PV, SV : EUS 0 % MV : EU 0 %	
REM.E	OFF, ON	-	OFF	-. For products with the RET option
REM.H	$1V \leq R-VL < R-VH \leq 5V$	V	5.000	
REM.L			1.000	
R-SH	*3) FR.L ~ FR.H *4) SL.L ~ SL.H	*2)	*3) FR.H *4) SL.H	
R-SL	(however, R-SL < R-SH)	*2)	*3) FR.L *4) SL.H	
R-AH	EUS (-5.0 ~ 5.0) %	*2)	EUS 0.0 %	
R-AL	EUS (-5.0 ~ 5.0) %		EUS 0.0 %	

\*2) According to G.IN> UNIT

\*3) TC, RTD

\*4) DCA, DCV, DCmV

## ◆ Retransmission output (RET)

### ■ Retransmission Type (RET.T)

Three modes of PV, SV and MV are supported for retransmission output.

The set mode value is proportional to the current output value of 4 ~ 20 mA.

### ■ T-SH (Retransmission Scale High)

### ■ T-SL (Retransmission Scale Low)

T-SH and T-SL are output ranges from 4 to 20 mA, and the setting range varies according to the input type.

For TC and RTD, the setting range is  $FRL \leq T-SL < T-SH$ .

For DCA, DCV, DCmV, the setting range is  $SLL \leq T-SL < T-SH \leq SLH$ .

For example, to output PV (0 ~ 1000 °C) with 4 ~ 20 mA using TC-K type sensor, set T-SH = 1000 and T-SL to 0.

### ■ T-AH (Retransmission Adjustment High)

### ■ T-AL (Retransmission Adjustment Low)

Since there is an error of the retransmission output (4 ~ 20 mA) of this product and an error of the input (4 ~ 20 mA) of the product that receives the input, the error may be expressed as the sum of the errors of the two products. Therefore, the error can be eliminated by calibrating the high and low limits of the output volume within  $\pm 5.0\%$  range each.

## ◆ Remote input (REM)

Analog signals from 4 to 20 mA (or 1 to 5 V) can be input from the equipment connected to this product and used as SV. For 4 ~ 20 mA input, when you connect 250  $\Omega$  resistor in parallel (we recommend resistor with max. 0.1% high-precision resistor), the high and low voltage input ranges of the remote input should be set to 1.000 ~ 5.000 V unit.

### ■ REM.E (Remote Input Enable)

For remote input products, you can use the remote input function by turning REM.E ON.

When REM.E is turned on, the value remotely input to the REM terminal is used as SV regardless of SV.NO of G.SV. (however, remote input SV is a data that exists only in RAM, so previous data will not be displayed during reset)

### ■ REM.H (Remote Input Voltage High)

### ■ REM.L (Remote Input Voltage Low)

Set the voltage range to be input by remote input (for more information, refer to the scale settings)

### ■ R-SH (Remote Input Scale High)

### ■ R-SL (Remote Input Scale Low)

Set the SV range corresponding to R-VH and R-VL.

For TC and RTD, the setting range is  $FRL \leq R-SL < R-SH \leq FRH$ .

For DCA, DCV, DCmV, the setting range is  $SLL \leq R-SL < R-SH \leq SLH$ .

### ■ R.AH (Remote Input Adjustment High)

### ■ R.AL (Remote Input Adjustment Low)

Since there is an error of the remote input (4 ~ 20 mA) of this product and an error of the output (4 ~ 20 mA) of the product that transfers, the error may be expressed as the sum of the errors of the two products. Therefore, the error can be eliminated by calibrating the high and low limits of the input volume within  $\pm 5.0\%$  range each. The set value display unit is fixed at  $^{\circ}\text{C}$ .

◆ G.SUB (Sub Group)

Parameter	Setting range	Unit	Initial value	Display condition
SUB1	NONE ALM1, ALM2, ALM3,ALM4 HBA(Opt), LBA	-	ALM1	-. For sub output options 1 to 4
SUB2			ALM2	-. For sub output options 2 to 4
SUB3			ALM3	-. For sub output options 3 to 4 VX4 exceptions -. When the OUT2 option is RLY -. G.OUT>CNT2 = NONE
SUB4			ALM4	-. For sub output option 4
A1.ND	0 ~ 999	Time (seconds)	0	-. G.SUB>SUBx = ALM1
A1.FD	0 ~ 999	Time (seconds)	0	
A1.EC	NO, NC	-	NO	
A1.LT	OFF, ON	-	OFF	
A2.ND	0 ~ 999	Time (seconds)	0	-. G.SUB>SUBx = ALM2
A2.FD	0 ~ 999	Time (seconds)	0	
A2.EC	NO, NC	-	NO	
A2.LT	OFF, ON	-	OFF	
A3.ND	0 ~ 999	Time (seconds)	0	-. G.SUB>SUBx = ALM3
A3.FD	0 ~ 999	Time (seconds)	0	
A3.EC	NO, NC	-	NO	
A3.LT	OFF, ON	-	OFF	



A4.ND	0 ~ 999	Time (seconds)	0	-. G.SUB>SUBx = ALM4
A4.FD	0 ~ 999	Time (seconds)	0	
A4.EC	NO, NC	-	NO	
A4.LT	OFF, ON	-	OFF	
LB.ND	0 ~ 999	Time (seconds)	0	-. G.SUB>SUBx = LBA
LB.FD	0 ~ 999	Time (seconds)	0	
LB.EC	NO, NC	-	NO	
LB.LT	OFF, ON	-	OFF	
HB2.E	OFF, ON	-	OFF	-. For models with CT option = 2
HB.ND	0 ~ 999	Time (seconds)	0	-. G.SUB>SUBx = HBA
HB.FD	0 ~ 999	Time (seconds)	0	
HB.EC	NO, NC	-	NO	
HB.LT	OFF, ON	-	OFF	

■ SUBn (Sub Output No.n Type)

The sub output can be used by connecting general alarm, heater break alarm and loop break alarm.

The number of the sub output indicates the output number of the hardware, and the connected alarm indicates software alarm. Therefore, when you connected with SUB1 = ALM3, it means that, if ALM3 alarm is generated, it will output through SUB1 terminal.

In the VX4, up to two sub outputs can be selected by suffix code. Up to three sub outputs can be used for models with relay output (M) as OUT2 by parameter setting.

✓ The usage is as follows

1. Set the CNT2 parameter of the G.OUT group to NONE.
2. Set the SUBn of the G.SUB group to ALM3.
3. Set the parameters related to alarm 3 of G.ALM group.

■ An.ND (Alarm No.n Turn ON Delay Time)

When an alarm condition occurs, the alarm output is output after the delay time by the time set in Ax.ND (however, if Ax.ND is 0, it is output immediately).

■ An.FD (Alarm No.n Turn OFF Delay Time)

When the alarm condition is released after the alarm condition occurs, the alarm output is released after the delay time by the time set in An.FD. (however, if An.FD = 0 it is output immediately).

You can set the delay time for alarm output ON or OFF when alarm condition is generated or released. After the alarm is generated as shown in the below picture, after Alarm (Alarm n. Turn on delay time), the alarm output is generated. After the alarm is released, after An.FD (Alarm n. Turn off delay time) the alarm output is released.

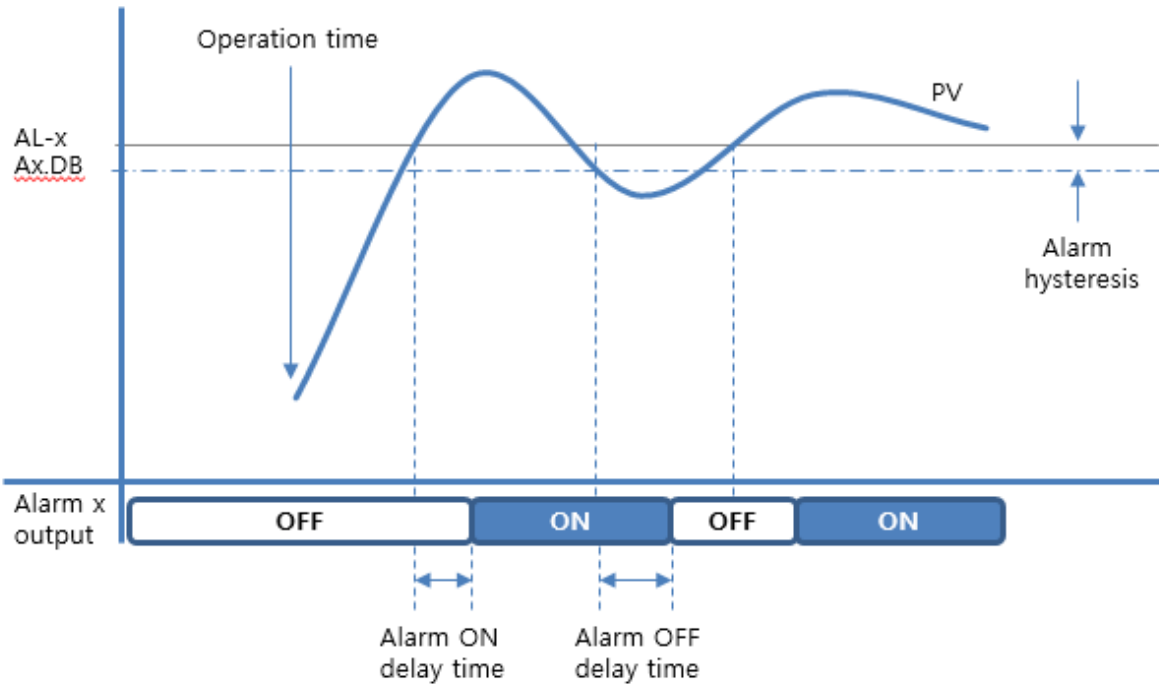

[Picture. Alarm operation example when ON/OFF Delay Time is set]

While the alarm OFF delay time is set, the Latch release function will not operate. Therefore, after the alarm releasing condition, the latch can be disabled after An.FD.

■ An.EC (Alarm No.n Electric Contact)

The sub output relay is A contact (NO: Normal Open) by hardware. However, you can use NO and NC by An.EC after power input.

If NO is selected, it is 'Open' in alarm releasing condition and 'Close' in alarm condition. Conversely, when NC is selected, it is 'Close' in alarm releasing condition and 'Open' in alarm condition.

■ An.LT (Alarm No.n Latch)

The latch function is used to hold the alarm output state.

When An.LT = ON, G.ALM>An.LR is automatically set to SET when Alarm No.n is an alarm condition.

At this time, G.ALM> Ax.LR holds SET and alarm output is not released even if Alarm No.n becomes an alarm releasing condition.

To release the alarm, the user must set forcibly G.ALM> Ax.LR to RST with the alarm releasing condition, and Alarm No.n alarm will be released.

■ LB.ND (Loop Break Alarm ON Delay Time)

When an alarm condition occurs, the alarm output is output after the delay time by the time set in LB.ND (however, if LB.ND is 0, it is output immediately).

■ LB.FD (Loop Break Alarm OFF Delay Time)

If an LBA alarm is generated and the control output is not 0% or 100%, or PV enters the LB.DB range, the LBA is released. At this time, if LB.FD is set to a value other than 00, it will be released after that time elapses.

■ LB.EC (Loop Break Alarm Electric Contact)

The sub output relay is A contact (NO: Normal Open) by hardware. However, you can use NO and NC by LB.EC after power input.

If NO is selected, it is 'Open' in alarm releasing condition and 'Close' in alarm condition. Conversely, when NC is selected, it is 'Close' in alarm releasing condition and 'Open' in alarm condition.

■ LB.LT (Loop Break Alarm Latch)

The latch function is used to hold the alarm output state. When LB.LT = ON, G.ALM>LB.LR is automatically set to SET when LBA is an alarm condition. At this time, G.ALM>LB.LR holds SET and alarm output is not released even if LBA becomes an alarm releasing condition. To release the alarm, the user must set forcibly G.ALM>LB.LR to RST with the alarm releasing condition, and LBA will be released.

■ HB2.E (Heater Break Alarm No.2 Enable)

For models with HBA CT2, you can select whether to use channel 2 or not. To use channel 2, set HB2.E to ON.

■ HB.ND (Heater Break Alarm Turn ON Delay Time)

When an HB alarm condition occurs, the alarm output is output after the delay time by the time set in HB.ND (however, if HB.ND is 0, it is output immediately).

■ HB.FD (Heater Break Alarm Turn OFF Delay Time)

When the HB alarm condition is released after the alarm condition occurs, the alarm output is released after the delay time by the time set in HB.FD. (however, if HB.FD 0 0 it is output immediately).

■ HB.EC (Heater Break Alarm Electric Contact)

The sub output relay is A contact (NO: Normal Open) by hardware. However, you can use NO and NC by HB.EC after power input.

If NO is selected, it is 'Open' in alarm releasing condition and 'Close' in alarm condition. Conversely, when NC is selected, it is 'Close' in alarm releasing condition and 'Open' in alarm condition.

■ HB.LT (Heater Break Alarm Latch)

The latch function is used to hold the alarm output state.

When HB.LT = ON, G.ALM>HB.LR is automatically set to SET when HBA is an alarm condition. At this time, G.ALM>HB.LR holds SET and alarm output is not released even if HBA becomes an alarm releasing condition. To release the alarm, the user must set forcibly G.ALM>HB.LR to RST with the alarm releasing condition, and HBA will be released.

## ◆ G.COM (Communication Group)

Parameter	Setting range	Unit	Initial value	Display condition
PRS	PCK, PCKS, ASCII, RTU	-	PCK	-. For models with RS-485 option
BPS	4.8K / 9.6K / 14.4K / 19.2K / 38.4K / 57.6K	BPS	9.6K	
PRI	NONE, EVEN, ODD	bit	NONE	
STOP	1 or 2	bit	1	
D.LEN	7 or 8	bit	8	
ADDR	1 ~ 99	-	1	
RP.TM	0 ~ 10	time	0	

### Communication

Supports PC Link and Modbus protocols in 2-wire half-duplex mode of EIA RS-485 standard.

#### ■ Protocol Select (PRS)

You can select from the following 4 protocols:

- PC Link without Checksum (PC Link STD)
- PC Link with Checksum (PC Link with SUM)
- Modbus ASCII
- Modbus RTU

Because PC Link without Checksum does not have Checksum, it cannot verify data integrity if data is distorted due to communication line noise, etc. However, PC Link with Checksum and Modbus ASCII / RTU can verify data integrity with Checksum, so it can be used more reliably. Therefore, we recommend not to use PC Link without Checksum except for testing.

#### ■ BPS (Bit Per Sec.)

You can select from the following 6 communication speeds: 4800, 9600, 14400, 19200, 38400,

57600 bps

- PRI (Parity bit)

You can select from the following 3 parity bits: NONE, EVEN, ODD

- STOP (Stop bit)

You can select from the following 2 stop bits: 1 or 2 bit

- D.LEN (Data Length)

You can select from the following 2 data lengths: 7 or 8 bit

- ADDR (Address)

Communication addresses can be used from 1 to 99, but up to 31 devices can be connected.

- RP.TM (Response Delay Time)

The response delay time is the delay time from the handling of the received data to the start of transmission and is calculated as follows.

Response Delay Time = received data handling time + (set response delay time X 50 msec)

◆ **G.SET (Setup Group)**

Parameter	Setting range	Unit	Initial value	Display condition
DI.MD	OFF/ ON	-	OFF	-. For DI optional models
PO.OM	STOP, RUN	-	STOP	-. Always displayed
P.INT	OFF, ON	-	OFF	-. Always displayed
Y/N	NO, YES	-	NO	-. G.SET>P.INT = ON
LOCK	0 ~ 2	-	0	-. Always displayed
E2P.L	OFF, ON	-	OFF	-. Always displayed

■ DI.MD (Digital Input Mode Select)

DI is displayed on the optional product, and DI can be used to turn on DI.MD.

The DI options are divided into two DI options and four DI options, and the functions vary accordingly.

Please refer to the table below for details

✓ If DI is 2 EA (DI 1 & 2)

Function		DI 1	DI 2
R/S	STOP	0	-
	RUN	1	-
SV	SV 1	-	0
	SV 4 or REM	-	1

✓ If DI is 4 EA (DI 1 ~ 4)

Function		DI 1	DI 2	DI 3	DI 4
R/S	STOP	0	-	-	-
	RUN	1	-	-	-
SV	SV 1	-	0	0	-
	SV 2	-	1	0	-
	SV 3	-	0	1	-
	SV 4 or REM	-	1	1	-



ALM LATCH	RESET	-	-	-	1
--------------	-------	---	---	---	---

- PO.OM (Power ON Operation Mode)

You can select the start mode after the power is supplied.

Set PO.OM to RUN to be in control state with power ON, and PO.OM to STOP to be in monitoring state.

- P.INT (Parameter Initialize)

It can be used when you want to change all the parameters set in the unit to the factory initial state.

Set P.INT to ON for factory initialization (however, a confirmation procedure is added to prevent initialization by user mistake.)

- Y/N (Confirm)

Confirms again whether parameter initialization is performed with parameters displayed only when G.SET> P.INT is set to ON. If Y/N is set to Yes, all parameters of the instrument will be changed to the factory initial state. However, if Y/N is set to No, parameter initialization will be canceled.

With this parameter, you can prevent the initialization by user mistake.

- LOCK (Lock)

Parameter group can be locked.

Locked groups are read-only and can only be read via communication.

If LOCK is 0, Lock is released. If LOCK is 1, all parameters except LOCK are locked.

If LOCK is 2, all parameters except LOCK and G.SV are locked

(when setting LOCK with SET and SHIFT buttons, LOCK is set to '2' and locked).

If you press the SET button to change the parameter set with the lock function, LOCK will blink. At this time, if you press the DOWN, UP or MD buttons, the LOCK indicator will disappear.

- E2P.L (EEPROM Lock)

In general, data used for communication is stored in RAM and in EEPROM according to the properties. However, if the user needs to continue writing due to a communication bug or unavoidable communication, the life of the EEPROM must be kept in mind (in general, the life of the EEPROM limits writing to 1 million times)

In this case, if E2P.L is ON, all data written by communication will be stored in RAM only and will not be stored in EEPROM (however, LOCK and E2P.L are stored in EEPROM, so do not exceed EEPROM write life).

This use can prevent the EEPROM from exceeding its life, but it cannot hold existing data during reset. Therefore, when a situation such as a power reset occurs, data received via communication disappear from RAM and data stored in EEPROM are displayed in RAM.

It is recommended that this function to be used as a method to prevent the EEPROM from exceeding its lifetime with excessive write commands.

## ◆ G.OUT (Output Group)

Parameter	Setting range	Unit	Initial value	Display condition
CNT1	ONOF, PID	-	PID	- . Always displayed
CNT2	NONE, ONOF, PID	-	PID	- . OUT2 option: RLY
O.ACT	REV, DIR	-	REV	- . G.OUT>CNT2 = NONE
CP	(1 ~ 1000) s	Time (seconds)	RLY : 20 SSR : 2	- . When the OUT1 option is RLY or SSR - . G.OUT>CNT1 = PID
CPC	(1 ~ 1000) s	Time (seconds)	RLY : 20 SSR : 2	- . When the OUT2 option is RLY - . G.OUT>CNT2 = PID
HYS	EUS (0.0~100.0) %	*2)	1	- . G.OUT>CNT1 = ONOF
HYSC	EUS (0.0~100.0) %	*2)	1	- . G.OUT>CNT2 = ONOF
EO	*5) (-5.0~105.0) % *6) (0.0~105.0) %	%	0.0	- . Always displayed
EOC	(0.0~105.0) %	%	0.0	- . G.OUT>CNT2 ≠ NONE
OL-H	*5) (-5.0~105.0) % *6) (0.0~105.0) % (however, OL-L < OL-H)	%	100.0	- . G.OUT>CNT1 = PID
OL-L	*5) (-5.0~105.0) % *6) (0.0~105.0) % (however, OL-L < OL-H)	%	0.0	- . G.OUT>CNT1 = PID or - . G.OUT>CNT2 = PID (at OUT2 = RLY)

\* 2) According to G.IN> UNIT

\*5) heating type

\*6) heating/cooling type

### ■ CNT1 (OUT1 Control mode)

The control output mode of OUT1 can be selected from ON / OFF or PID.

- CNT2 (OUT2 Control mode)

The control output mode of OUT2 can be selected from NONE, ON / OFF or PID.

- O.ACT (Output Action)

The operation in which the control amount increases when the deviation (PV - SV) is positive is referred to as a direct action, and the operation in which the control amount increases when the deviation is negative is referred to as a reverse action.

O.ACT = 1 (Direct)

O.ACT = 0 (Reverse)

You can select direct or reverse action only when OUT2 option is not available or G.OUT > CNT2 = NONE.

- CP (Control Period - Heating)

OUT1 is set when it is Relay or SSR by OUT1 (heating) control output period

- CPC (Control Period - Cooling)

OUT2 is set when it is Relay by OUT2 (cooling) control output period.

- HYS (Hysteresis - Heating)

- HYSC (Hysteresis - Cooling)

In the heating control or heating / cooling control, the output dead band of the heating side and cooling sides can be set individually.

The deadband during heating / cooling ON / OFF control is as follows:

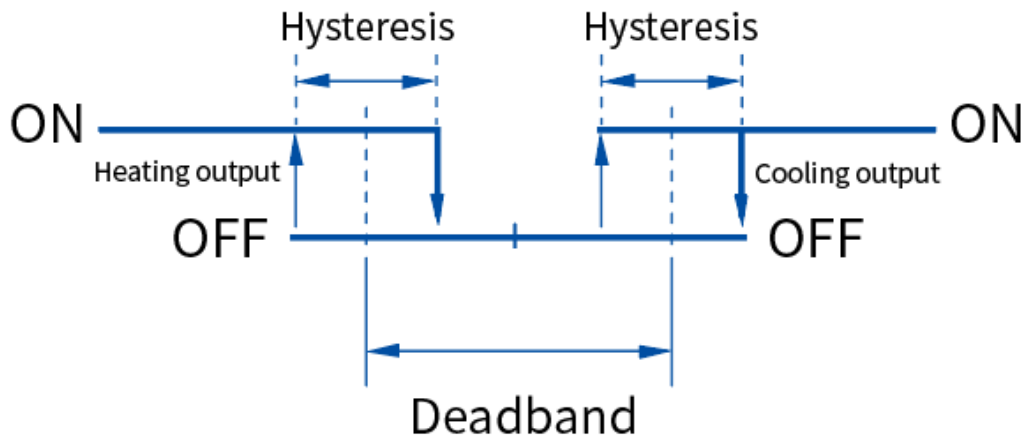

HYS and HYSC are displayed only when CNT1 and CNT2 are ON / OFF control respectively.

- EO (Emergency Output - Heating)
- EOC (Emergency Output - Cooling)

The output amount set during A / D error and BURN OUT (Preset Out) is output.

OUT1 outputs PRESET OUT by EO value (however, when OUT1 is ON / OFF control, EO = 0 or 100% is output). OUT2 outputs PRESET OUT by EOC value.

The output conditions of EO and EOC according to the conditions are as follows.

When using only CNT1 (CNT2 as NONE or models without OUT2 option), emergency output EO is generated as shown below according to ON / OFF and PID settings.

Item	CNT1	
	ON/OFF	PID
EO range	EO = 0.0 % or 100.0 %	$0.0 \leq EO \leq 100.0$

MV output	MV = EO	OLL > EO (MV = 0.0 %)
		OLH < EO (MV = OLH)
		OLL ≤ EO ≤ OLH (MV = EO)

When ON / OFF is set, OLL and OLH are not displayed, but OLL = 0.0 and OLH are set to 100.0.

EO can be set to 0.0 or 100.0.

At this time, if an emergency output condition occurs, MV (OUT1) is output with the value set in EO.

When PID is set, the setting range of OLL and OLH varies depending on the output type.

EO can be set from 0.0 or 100.0.

At this time, MV (OUT1) will be output as the above condition when the emergency output situation occurs.

When both CNT1 and CNT2 are used, EO and EOC are generated as follows.

When both CNT1 and CNT2 are ON / OFF, OLL and OLH are not displayed, but OLL is set to 0.0 and OLH is set to 100.0.

Item	CNT1	
	ON/OFF	PID
EO range	EO = 0.0 % or 100.0 %	0.0 ≤ EO ≤ 100.0
HOUT output	OLH < 100.0 (HOUT = 0.0)	OLH < EO (HOUT = OLH)
	HOUT = EO	0 ≤ EO ≤ OLH (HOUT = EO)

In ON / OFF, if OLH is set to a value less than 100, it will not operate even if EO value is set.

In ON / OFF, EO can be set to 0.0 or 100.0, and in PID, it can be set from 0.0 to 100.0.

At this time, if an emergency output condition occurs, HOUT(OUT1) is output with the value set in EO.

However, if OLH is set to a value less than 100, EO will not be output.

The output condition of PID is as shown in the above table.

Item	CNT2	
	ON/OFF	PID
EOC range	EOC = 0.0 % or 100.0 %	$0.0 \leq \text{EOC} \leq 100.0$
COUT output	$\text{OLL} < 100.0$ (COUT = 0.0)	$\text{OLH} < \text{EOC}$ (COUT = OLH)
	COUT = EOC	$0 \leq \text{EOC} \leq \text{OLH}$ (COUT = EOC)

In ON / OFF, if OLL is set to a value less than 100, it will not operate even if EOC value is set.

In ON / OFF, EOC can be set to 0.0 or 100.0, and in PID, it can be set from 0.0 to 100.0.

At this time, if an emergency output condition occurs, COUT(OUT2) is output with the value set in EOC. However, if OLL is set to a value less than 100, EOC will not be output.

The output condition of PID is as shown in the above table.

- OL-H (Output Limit High)
- OL-L (Output Limit Low)

For models with only OUT1 or where G.OUT > CNT2 is NONE, OL-H is the output high limit and OL-L is the output low limit. The control output (MVOUT) is output under the following conditions:

(In case of SSR or RLY:  $0.0 \% \leq \text{OL-L} \leq \text{MVOUT} \leq \text{OL-H} \leq 100.0 \%$ )

(In case of SCR:  $-5.0 \% \leq \text{OL-L} \leq \text{MVOUT} \leq \text{OL-H} \leq 105.0 \%$ )

If G.OUT > CNT2 is not NONE in models with OUT2 option, OL-H is the heating output high limit value and OL-L is the cooling output high limit value.

The heating output is output under the following conditions:  $(0.0 \% \leq \text{H.OUT} \leq \text{OL-H})$

The cooling output is output under the following conditions:  $(0.0 \% \leq \text{C.OUT} \leq \text{OL-L})$

◆ **G.IN (Input Group)**

Parameter	Setting range	Unit	Initial value	Display condition
INP	K0 ~ 0.1V	-	K0	-. Always displayed
UNIT	*3) °C, °F *4) °C, °F, %, no unit	-	°C	-. Always displayed
DP-P	0 ~ 3	-	1	-. When G.IN>INP = DCA, DCV, DCmV
SL-H	-1999 ~ 9999 (however, SL.L < SL.H)	*2)	100.0	
SL-L		*2)	0.0	
RJC	OFF, ON	-	ON	-. When G.IN>INP = TC -. TC : K0 ~ PLII
FILT	OFF, 1 ~ 120	Time (seconds)	OFF	-. Always displayed
BIAS	EUS (-100.0~100.0) %	*2)	EUS 0.0 %	-. Always displayed

\* 2) According to G.IN> UNIT

\*3) TC, RTD

\*4) DCA, DCV, DCmV

■ **INP (Input Type)**

INP is a parameter for selecting the input type. Please refer to the 'Input type and range setting' table.

■ **UNIT (Unit)**



INP can be set to °C and °F in TC (Thermocouple) and RTD, and the value between two units is automatically converted. In DCA, DCV and DCmV, it can be set in ° C, ° F, %, " (no unit). Only the units are displayed but not converted.

■ DP-P (Dot Point Position)

The parameters used in DCA, DCV and DCmV determine the dot points of the values set in the scales (SL-L, SL-H).

■ SL-H (Scale High Limit)

DCA, DCV and DCmV are used as the high input range (refer to the 'Input type and range setting' table).

■ SL-L (Scale Low Limit)

DCA, DCV and DCmV are used as the low input range. (refer to the 'Input type and range setting' table).

■ RJC (Reference Junction Compensation)

If the temperature sensor is used as a thermocouple (TC), it basically compensates the reference junction temperature and displays the present value (PV). If the thermocouple input is input as the junction compensation value, set RJC to OFF. The RJC is then displayed as a non-inclusive value.

■ FILT (Filter)

When noise is repeatedly applied to the present value (PV), this parameter is used to remove it.

Noise not only deteriorates the control characteristics, but also causes the output to increase suddenly.

However, when the input filter (FL) is set largely, the actual measured value is expressed with delay.

■ BIAS (Bias)

This parameter is set when the temperature calibration of the present value (PV) is required.

The present value is displayed as the sum of the present value before input calibration and the value set for input calibration.

## For your reference

### ◆ Term Descriptions

- ✓ FR.L: The temperature range is defined according to TC and RTD types in 'Input specifications', and the minimum value of this range is called FR.L (for example, for TC K type, FR.L is -200 degrees).
- ✓ FR.H: The temperature range is defined according to TC and RTD types in 'Input specifications', and the maximum value of this range is called FR.H. (for example, for TC K type, FR.H is 1370 degrees).
- ✓ S.L.L: The scale range is defined according to direct current and direct voltage types in 'Input specifications', and the minimum value of this range is called S.L.L (for example, for 1~ 5V type, S.L.L is -1999 degrees).
- ✓ S.L.H: The scale range is defined according to direct current and direct voltage types in 'Input specifications', and the maximum value of this range is called S.L.H. (for example, for 1~ 5V type, S.L.H is 9999 degrees).
- ✓ ※ FR.L and FR.H are unchangeable, S.L.L and S.L.H are changeable.

### ◆ Engineering Units

- ✓ EU: the value of the engineering unit according to the instrument range

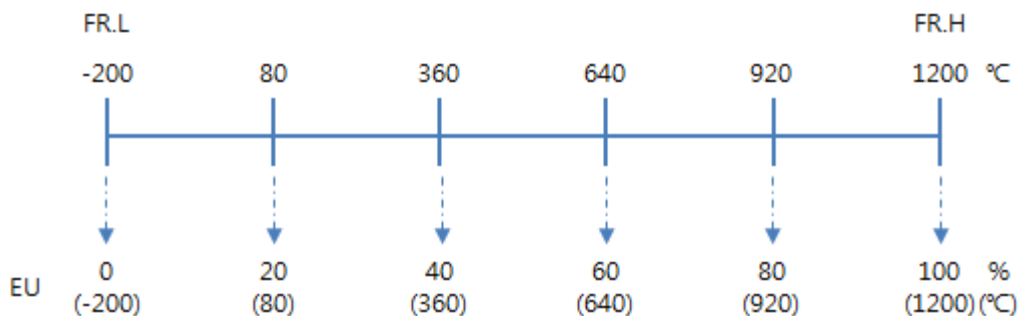

At the same conditions as in the above figure, the temperature corresponding to EU 40% can be calculated as follows.

$$\text{Value} = (\text{FRH} - \text{FRL}) \times \frac{\text{Rate}}{100} + \text{FRL} = (1200 - (-200)) \times \frac{40}{100} + (-200) = 360$$

That is, the temperature corresponding to EU 40% is 360 °C..

✓ EUS : the value of the engineering unit range according to the instrument span

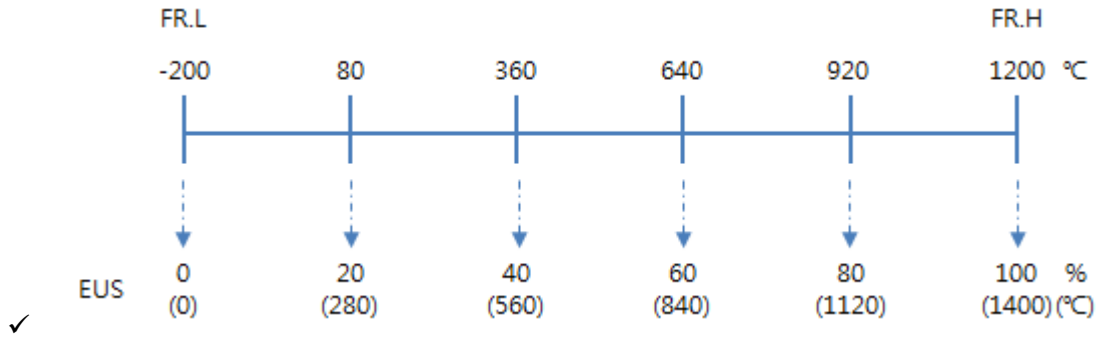

At the same conditions as in the above figure, the temperature corresponding to EUS 40% can be calculated as follows.

$$\text{Value} = (\text{FRH} - \text{FRL}) \times \frac{\text{Rate}}{100} = (1200 - (-200)) \times \frac{40}{100} = 560$$

That is, the temperature corresponding to EUS 40% is 560 °C.

### ◆ Scale change of DCA, DCV, DCmV

In case of analog input, it goes through scale which converts input voltage into display value.

In the example below, 1/5 V type is shown as an example. If there is no change in SL-L, SL-H values, it will be as shown in the picture below.

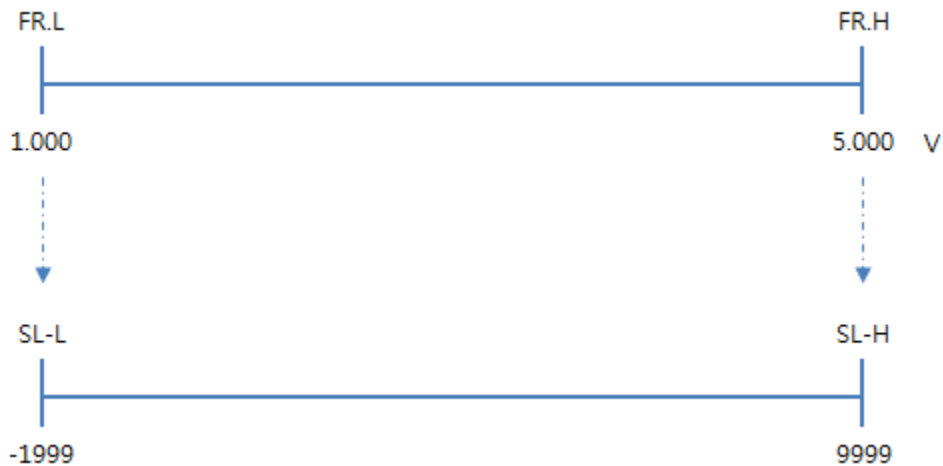

That is, -1999 is displayed during 1.000 V, and 9999 is displayed during 5.000 V.

If you change the values of SL-L, SL-H as shown below

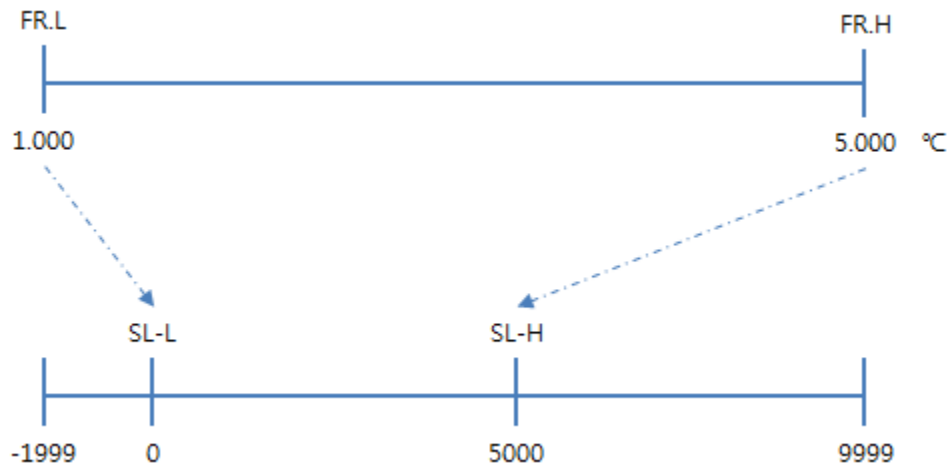

When it is 1.000 V, 0 is displayed. When it is 5.000 V, 5000 is displayed.

The remote input receives input in the same way.

#### ◆ Changing the retransmission output range

When TC or RTD is selected as the input sensor, FR.L, FR.H values are set to initial ranges according to input types. SL-L and SL-H values are set when selecting DCA, DCV and DCmV,. When FR.L and SL-L are called FSL (Full Scale Low), FR.H and SL-H are FSH (Full Scale High), the retransmission output range is as shown in the below picture. The following example shows TC K type.

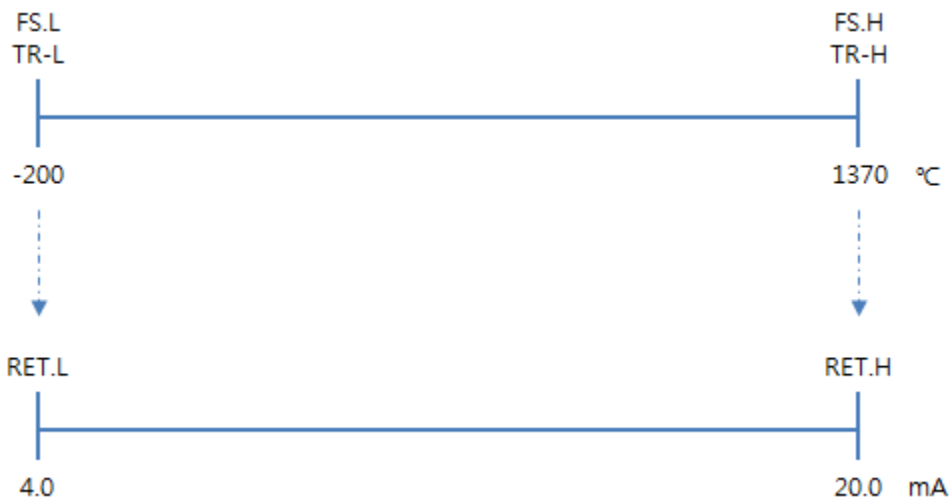

If the retransmission output low limit value (TR-L) and high limit value (TR-H) value are not changed as shown in the figure above, the output is as shown in the picture.

That is, 4.0 mA is output at -200 ° C, and 20.0 mA is output at 1370 ° C.

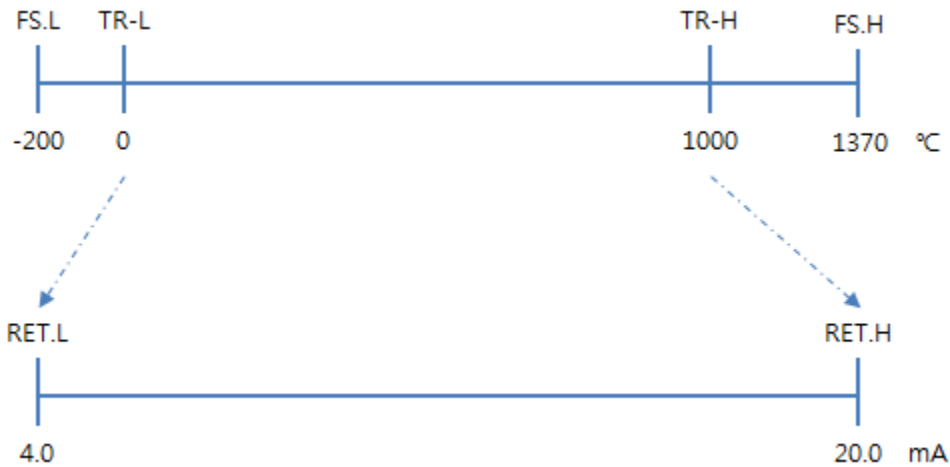

If the retransmission output low limit value (TR-L) and high limit value (TR-H) value are changed as shown in the figure above, the output is as shown in the picture.

4.0 mA is output at 0 ° C, and 20.0 mA is output at 1000 ° C.

The formula is as follows.

$$\text{Output current (mA)} = \frac{(\text{Temp} - \text{FRL}) \times (\text{RETH} - \text{RETL})}{(\text{FRH} - \text{FRL})} + \text{RETL}$$

Therefore, the output current is 6.038 mA at 0 ° C before the retransmission output low limit value (TR-L) and high limit value (TR-H) change.

The output current is 4.0 mA at 0 ° C after the retransmission output low limit value (TR-L) and high limit value (TR-H) change.

◆ Error Message

No	Display	Display name	Causes and measures
1	SYSE	System Data	✓ System data setting error (please contact us)
2	OPT.E	Option Data	✓ Option data setting error (please contact us)
3	E2PE	EEPROM	✓ EEPROM error (please contact us)
4	ADCE	AD Converter	✓ AD Converter error (please contact us)
5	CALE	Calibration	✓ Calibration value setting error (please contact us)
6	RJCE	RJC	✓ Reference junction compensation error (please contact us)
7	ATE	Auto Tuning	<ul style="list-style-type: none"> <li>✓ Auto-tuning maximum elapsed time (24h) exceeded</li> <li>- Check if the connected sensor and the set sensor are different.</li> <li>- When control output is 100%, output does not come out from output terminals (please contact us).</li> <li>- If the control output is generated from the instrument but the PV does not change (check the wiring state).</li> <li>- If the PV changes too slowly when the control output is 0% (check the wiring state or the system)</li> <li>- If there is no control output, enter the P, I, D values manually without running AT for systems where temperature is not likely to drop.</li> </ul>
8	BOUT	Burn out	<ul style="list-style-type: none"> <li>✓ Check sensor wiring state (check for disconnections)</li> <li>✓ Check the sensor setting state</li> <li>✓ Input exceeds <math>\pm</math> OVER</li> </ul>
9	OVR	+Over	<ul style="list-style-type: none"> <li>✓ Check the sensor setting state</li> <li>✓ When input is exceeded within +5% of sensor input</li> </ul>

			range.
10	-OVR	-Over	<ul style="list-style-type: none"> <li>✓ Check the sensor setting state</li> <li>✓ When input is exceeded within -5% of sensor input range.</li> </ul>

※ The error message is displayed on the PV display.

## Communication

### ◆ Communication map

- Process (address 0 ~ 99)

Address		D-register		Parameter		R/W	RAM (Only)
DEC	HEX	DEC	HEX				
40001	9C41	0	0000	CPV	Current temperature	RO	O
40002	9C42	1	0001	CSV	Current set temperature	RO	O
40003	9C43	2	0002	TSV	Final set temperature	RO	O
40004	9C44	3	0003	DP-P	Dot point	RO	O
40005	9C45	4	0004	UNIT	Unit	RO	O
40006	9C46	5	0005	MVOUT	Output amount	RO	O
40007	9C47	6	0006	OUT1 (Heat)	Heating output amount	RO	O
40008	9C48	7	0007	OUT2 (Cool)	Cooling output amount	RO	O
40009	9C49	8	0008	PID.NO	PID number	RO	O
40010	9C4A	9	0009	SV.NO	SV number	RO	O
40011	9C4B	10	000A	NOW_STS	Current state	RO	O
40012	9C4C	11	000B	ERR_STS	Error status	RO	O
40013	9C4D	12	000C	SUB_STS	Sub output status	RO	O
40014	9C4E	13	000D	ALM_STS	Alarm status	RO	O
40015	9C4F	14	000E	DI_STS	DI status	RO	O
40016	9C50	15	000F	CT1.M	CT1 current amount	RO	O
40017	9C51	16	0010	CT2.M	CT2 current amount	RO	O
40018	9C52	17	0011	R/S	Run/Stop	RO	O
40019	9C53	18	0012	AT	Auto-Tuning	RO	O
40020	9C54	19	0013	A/M	Auto/Manu	RO	O



40021	9C55	20	0014	AL1.M	ALM1 monitoring	RO	O
40022	9C56	21	0015	AL2.M	ALM2 monitoring	RO	O
40023	9C57	22	0016	AL3.M	ALM3 monitoring	RO	O
40024	9C58	23	0017	AL4.M	ALM4 monitoring	RO	O
40025	9C59	24	0018	LBA.M	LBA monitoring	RO	O
40026	9C5A	25	0019	HBA.M	HBA monitoring	RO	O
40032	9C60	31	001F	A/M	Auto/Manu	RW	O
40033	9C61	32	0020	MV IN	Manual output amount input	RW	O
40034	9C62	33	0021	R/S	Run/Stop	RW	O

Address		D-register		Parameter		R/W	RAM (Only)
DEC	HEX	DEC	HEX				
40042	9C6A	41	0029	SYS	System Data	RO	
40043	9C6B	42	002A	OPT	Option Data	RO	
40044	9C6C	43	002B	SP1	Special Data (1)	RO	
40045	9C6D	44	002C	SP2	Special Data (2)	RO	
40046	9C6E	45	002D	FWV	Firmware Version	RO	

● G.SV (address 100 ~ 199)

Address		D-register		Parameter		R/W	RAM (Only)
DEC	HEX	DEC	HEX				
40101	9CA5	100	0064	SV.NO	Set value number selection	R/W	
40102	9CA6	101	0065	SV-H	SV setting high limit value	R/W	
40103	9CA7	102	0066	SV-L	SV setting low limit value	R/W	
40104	9CA8	103	0067	SV-1	Set value 1	R/W	
40105	9CA9	104	0068	SV-2	Set value 2	R/W	
40106	9CAA	105	0069	SV-3	Set value 3	R/W	

40107	9CAB	106	006A	SV-4	Set value 4	R/W	
-------	------	-----	------	------	-------------	-----	--

● G.CTL (address 200 ~ 299)

Address		D-register		Parameter		R/W	RAM (Only)
DEC	HEX	DEC	HEX				
40201	9D09	200	00C8	AT.MD	Auto-tuning mode	R/W	
40202	9D0A	207	00C9	AT	Auto-tuning	R/W	O
40205	9D0D	208	00CC	ARW	Anti-reset Windup	R/W	
40206	9D0E	209	00CD	ALPA	Alpha	R/W	
-	-	-	-	PID.N	PID Number	R/W	O
40211	9D13	210	00D2	1.P	Heating proportional band	R/W	
40212	9D14	211	00D3	1.I	Heating integral time	R/W	
40213	9D15	212	00D4	1.D	Heating derivative time	R/W	
40214	9D16	213	00D5	1.MR	Manual reset	R/W	
40215	9D17	214	00D6	1.Pc	Cooling proportional band	R/W	
40216	9D18	215	00D7	1.Ic	Cooling integral time	R/W	
40217	9D19	216	00D8	1.Dc	Cooling derivative time	R/W	
40218	9D1A	217	00D9	-	-	-	
40219	9D1B	218	00DA	1.DB	Heating / cooling deadband	R/W	
40220	9D1C	219	00DB	2.P	Heating proportional band	R/W	
40221	9D1D	220	00DC	2.I	Heating integral time	R/W	
40222	9D1E	221	00DD	2.D	Heating derivative time	R/W	
40223	9D1F	222	00DE	2.MR	Manual reset	R/W	
40224	9D20	223	00DF	2.Pc	Cooling proportional band	R/W	
40225	9D21	224	00E0	2.Ic	Cooling integral time	R/W	
40226	9D22	225	00E1	2.Dc	Cooling derivative time	R/W	
40227	9D23	226	00E2	-	-	-	
40228	9D24	227	00E3	2.DB	Heating / cooling deadband	R/W	

40229	9D25	228	00E4	3.P	Heating proportional band	R/W	
40230	9D26	229	00E5	3.I	Heating integral time	R/W	
40231	9D27	230	00E6	3.D	Heating derivative time	R/W	
40232	9D28	231	00E7	3.MR	Manual reset	R/W	
40233	9D29	232	00E8	3.Pc	Cooling proportional band	R/W	
40234	9D2A	233	00E9	3.Ic	Cooling integral time	R/W	
40235	9D2B	234	00EA	3.Dc	Cooling derivative time	R/W	
40236	9D2C	235	00EB	-	-	-	
40237	9D2D	236	00EC	3.DB	Heating / cooling deadband	R/W	
40238	9D2E	237	00ED	4.P	Heating proportional band	R/W	
40239	9D2F	238	00EE	4.I	Heating integral time	R/W	
40240	9D30	239	00EF	4.D	Heating derivative time	R/W	
40241	9D31	240	00F0	4.MR	Manual reset	R/W	
40242	9D32	241	00F1	4.Pc	Cooling proportional band	R/W	
40243	9D33	242	00F2	4.Ic	Cooling integral time	R/W	
40244	9D34	243	00F3	4.Dc	Cooling derivative time	R/W	
40245	9D35	244	00F4	-	-	-	
40246	9D36	245	00F5	4.DB	Heating / cooling deadband	R/W	
40247	9D37	246	00F6	RM.UP	Ramp-up temperature	R/W	
40248	9D38	247	00F7	UP.TM	Ramp-up time	R/W	
40249	9D39	248	00F8	RM.DW	Ramp-down temperature	R/W	
40250	9D3A	249	00F9	DW.TM	Ramp-down time	R/W	

● G.ALM (address 300 ~ 399)

Address		D-register		Parameter	R/W	RAM (Only)
DEC	HEX	DEC	HEX			
40301	9D6D	300	012C	A1.TY	Alarm 1 type	R/W
40302	9D6E	301	012D	AL-1	Alarm 1 set value	R/W

40303	9D6F	302	012E	A1.DB	Alarm 1 deadband	R/W	
40304	9D70	303	012F	A1.LS	Alarm 1 output hold status	R/W	○
40305	9D71	304	0130	A2.TY	Alarm 2 type	R/W	
40306	9D72	305	0131	AL-2	Alarm 2 set value	R/W	
40307	9D73	306	0132	A2.DB	Alarm 2 deadband	R/W	
40308	9D74	307	0133	A2.LS	Alarm 2 output hold status	R/W	○
40309	9D75	308	0134	A3.TY	Alarm 3 type	R/W	
40310	9D76	309	0135	AL-3	Alarm 3 set value	R/W	
40311	9D77	310	0136	A3.DB	Alarm 3 deadband	R/W	
40312	9D78	311	0137	A3.LS	Alarm 3 output hold status	R/W	○
40313	9D79	312	0138	A4.TY	Alarm 4 type	R/W	
40314	9D7A	313	0139	AL-4	Alarm 4 set value	R/W	
40315	9D7B	314	013A	A4.DB	Alarm 4 deadband	R/W	
40316	9D7C	315	013B	A4.LS	Alarm 4 output hold status	R/W	○
40317	9D7D	316	013C	LB.TM	Loop Break Alarm Time	R/W	
40318	9D7E	317	013D	LB.SV	Loop Break Alarm Temperature	R/W	
40319	9D7F	318	013E	LB.DB	Loop Break Alarm Deadband	R/W	
40320	9D80	319	013F	LB.LS	Loop Break Alarm Latch Status	R/W	○
40321	9D81	320	0140	HB-1	Heater Break Alarm 1 current	R/W	
40322	9D82	321	0141	H1.DB	Heater Break Alarm 1 current deadband	R/W	
40323	9D83	322	0142	HB-2	Heater Break Alarm 2 type	R/W	
40324	9D84	323	0143	H2.DB	Heater Break Alarm 2 current deadband	R/W	
40325	9D85	324	0144	HB.LS	Heater Break Alarm Latch Status	R/W	○

● G.TRS (address 400 ~ 499)

Address	D-register	Parameter	R/W	
---------	------------	-----------	-----	--

DEC	HEX	DEC	HEX				RAM (Only)
40401	9DD1	400	0190	RET.T	Retransmission output type	R/W	
40402	9DD2	401	0191	RET.H	Retransmission output high scale value	R/W	
40403	9DD3	402	0192	RET.L	Retransmission output low scale value	R/W	
40404	9DD4	403	0193	T-AH	Retransmission output high adjust value	R/W	
40405	9DD5	404	0194	T-AL	Retransmission output low adjust value	R/W	
40406	9DD6	405	0195	REM.E	Remote input selection	R/W	
40407	9DD7	406	0196	REM.H	Remote input high voltage setting	R/W	
40408	9DD8	407	0197	REM.L	Remote input low voltage setting	R/W	
40409	9DD9	408	0198	R-SH	Remote input high scale value	R/W	
40410	9DDA	409	0199	R-SL	Remote input low scale value	R/W	
40411	9DDB	410	019A	R-AH	Remote input adjust high value	R/W	
40412	9DDC	411	019B	R-AL	Remote input adjust low value	R/W	

● G.SUB (address 500 ~ 599)

Address		D-register		Parameter		R/W	RAM (Only)
DEC	HEX	DEC	HEX				
40501	9E35	500	01F4	SUB1	SUB1 output type	R/W	
40502	9E36	501	01F5	SUB2	SUB2 output type	R/W	
40503	9E37	502	01F6	SUB3	SUB3 output type	R/W	
40504	9E38	503	01F7	SUB4	SUB4 output type	R/W	

40505	9E39	504	01F8	A1.ND	Alarm 1 On Delay Time	R/W	
40506	9E3A	505	01F9	A1.FD	Alarm 1 Off Delay Time	R/W	
40507	9E3B	506	01FA	A1.EC	Alarm 1 contact type	R/W	
40508	9E3C	507	01FB	A1.LT	Alarm 1 output lock	R/W	
40509	9E3D	508	01FC	A2.ND	Alarm 2 On Delay Time	R/W	
40510	9E3E	509	01FD	A2.FD	Alarm 2 Off Delay Time	R/W	
40511	9E3F	510	01FE	A2.EC	Alarm 2 contact type	R/W	
40512	9E40	511	01FF	A2.LT	Alarm 2 output lock	R/W	
40513	9E41	512	0200	A3.ND	Alarm 3 On Delay Time	R/W	
40514	9E42	513	0201	A3.FD	Alarm 3 Off Delay Time	R/W	
40515	9E43	514	0202	A3.EC	Alarm 3 contact type	R/W	
40516	9E44	515	0203	A3.LT	Alarm 3 output lock	R/W	
40517	9E45	516	0204	A4.ND	Alarm 4 On Delay Time	R/W	
40518	9E46	517	0205	A4.FD	Alarm 4 Off Delay Time	R/W	
40519	9E47	518	0206	A4.EC	Alarm 4 contact type	R/W	
40520	9E48	519	0207	A4.LT	Alarm 4 output lock	R/W	
40521	9E49	520	0208	LB.ND	Loop Break Alarm On Delay	R/W	
40522	9E4A	521	0209	LB.FD	Loop Break Alarm Off Delay	R/W	
40523	9E4B	522	020A	LB.EC	Loop Break Alarm Electric Contact	R/W	
40524	9E4C	523	020B	LB.LT	Loop Break Alarm Latch	R/W	
40525	9E4D	524	020C	HB2.E	Heater Break Alarm Enable	R/W	
40526	9E4E	525	020D	HB.ND	Heater Break Alarm On Delay	R/W	
40527	9E4F	526	020E	HB.FD	Heater Break Alarm Off Delay	R/W	
40528	9E50	527	020F	HB.EC	Heater Break Alarm Electric Contact	R/W	
40529	9E51	528	0210	HB.LT	Heater Break Alarm Latch	R/W	

● G.COM (address 600 ~ 699)

Address		D-register		Parameter		R/W	RAM (Only)
DEC	HEX	DEC	HEX				
40601	9E99	600	0258	PRS	Protocol	R/W	
40602	9E9A	601	0259	BPS	Baud Rate	R/W	
40603	9E9B	602	025A	PRI	Parity bit	R/W	
40604	9E9C	603	025B	STOP	Stop bit	R/W	
40605	9E9D	604	025C	D.LEN	Data length	R/W	
40606	9E9E	605	025D	ADDR	Address	R/W	
40607	9E9F	606	025E	RP.TM	Response delay time	R/W	

● G.SET (address 700 ~ 799)

Address		D-register		Parameter		R/W	RAM (Only)
DEC	HEX	DEC	HEX				
40701	9EFD	700	02BC	DI.MD	DI mode	R/W	
40702	9EFE	701	02BD	PO.OM	Operation Mode after Power On	R/W	
40703	9EFF	702	02BE	P.INT	Parameter Initialization	R/W	O
40704	9F00	703	02BF	LOCK	Setting Lock	R/W	
40705	9F01	704	02C0	E2P.L	EEPROM Lock	R/W	

● G.OUT (address 800 ~ 899)

Address		D-register		Parameter		R/W	RAM (Only)
DEC	HEX	DEC	HEX				
40801	9F61	800	0320	CNT1	OUT1 Output Control Selection	R/W	
40802	9F62	801	0321	CNT2	OUT2 Output Control Selection	R/W	
40803	9F63	802	0322	O.ACT	Direct/Reverse Output Action	R/W	
40804	9F64	803	0323	CP	Heating Control Period	R/W	

40805	9F65	804	0324	CPC	Cooling Control Period	R/W	
40806	9F66	805	0325	HYS	Hysteresis	R/W	
40807	9F67	806	0326	HYSC	Hysteresis (Cooling)	R/W	
40808	9F68	807	0327	EO	Heating emergency output	R/W	
40809	9F69	808	0328	EOC	Cooling emergency output	R/W	
40810	9F6A	809	0329	OL-H	Output High Limit	R/W	
40811	9F6B	810	0330	OL-L	Output Low Limit	R/W	

● G.IN (address 900 ~ 999)

Address		D-register		Parameter	R/W	RAM (Only)
DEC	HEX	DEC	HEX			
40901	9FC5	900	0384	INP	Input Type selection	R/W
40902	9FC6	901	0385	UNIT	Unit selection	R/W
40905	9FC9	904	0388	DP-P	Dot Point Position Selection	R/W
40906	9FCA	905	0389	SL-H	Scale High Limit	R/W
40907	9FCB	906	038A	SL-L	Scale Low Limit	R/W
40908	9FCC	907	038B	RJC	Reference Junction Compensation	R/W
40909	9FCD	908	038C	FILT	Input Display Value Filter	R/W
40910	9FCE	909	038D	BIAS	PV Bias	R/W

● USER MAP SETTING (address 721 ~ 740)

Address		D-register		Parameter	R/W	Default	
DEC	HEX	DEC	HEX				
40722	9F12	721	02D1	UMS 01	1st User map	R/W	0
40723	9F13	722	02D2	UMS 02	2nd User map	R/W	1
40724	9F14	723	02D3	UMS 03	3rd User map	R/W	2



40725	9F15	724	02D4	UMS 04	4th User map	R/W	3
40726	9F16	725	02D5	UMS 05	5th User map	R/W	4
40727	9F17	726	02D6	UMS 06	6th User map	R/W	5
40728	9F18	727	02D7	UMS 07	7th User map	R/W	6
40729	9F19	728	02D8	UMS 08	8th User map	R/W	7
40730	9F1A	729	02D9	UMS 09	9th User map	R/W	8
40731	9F1B	730	02DA	UMS 10	10th User map	R/W	9
40732	9F1C	731	02DB	UMS 11	11th User map	R/W	10
40733	9F1D	732	02DC	UMS 12	12th User map	R/W	11
40734	9F1E	733	02DD	UMS 13	13th User map	R/W	12
40735	9F1F	734	02DE	UMS 14	14th User map	R/W	13
40736	9F20	735	02DF	UMS 15	15th User map	R/W	14
40737	9F21	736	02E0	UMS 16	16th User map	R/W	15
40738	9F22	737	02E1	UMS 17	17th User map	R/W	16
40739	9F23	738	02E2	UMS 18	18th User map	R/W	17
40740	9F24	739	02E3	UMS 19	19th User map	R/W	18
40741	9F25	740	02E4	UMS 20	20th User map	R/W	19

● USER DATA (address 1200 ~ 1219)

Address		D-register		Parameter		R/W	RAM (Only)
DEC	HEX	DEC	HEX				
41201	A0F1	1200	04B0	USER_DATA 01	1st User Data	R/W	Depends on setting data
41202	A0F2	1201	04B1	USER_DATA 02	2nd User Data	R/W	
41203	A0F3	1202	04B2	USER_DATA 03	3rd User Data	R/W	
41204	A0F4	1203	04B3	USER_DATA 04	4th User Data	R/W	
41205	A0F5	1204	04B4	USER_DATA 05	5th User Data	R/W	
41206	A0F6	1205	04B5	USER_DATA 06	6th User Data	R/W	
41207	A0F7	1206	04B6	USER_DATA 07	7th User Data	R/W	
41208	A0F8	1207	04B7	USER_DATA 08	8th User Data	R/W	

41209	A0F9	1208	04B8	USER_DATA 09	9th User Data	R/W
41210	A0FA	1209	04B9	USER_DATA 10	10th User Data	R/W
41211	A0FB	1210	04BA	USER_DATA 11	11th User Data	R/W
41212	A0FC	1211	04BB	USER_DATA 12	12th User Data	R/W
41213	A0FD	1212	04BC	USER_DATA 13	13th User Data	R/W
41214	A0FE	1213	04BD	USER_DATA 14	14th User Data	R/W
41215	A0FF	1214	04BE	USER_DATA 15	15th User Data	R/W
41216	A100	1215	04BF	USER_DATA 16	16th User Data	R/W
41217	A101	1216	04C0	USER_DATA 17	17th User Data	R/W
41218	A102	1217	04C1	USER_DATA 18	18th User Data	R/W
41219	A103	1218	04C2	USER_DATA 19	19th User Data	R/W
41220	A104	1219	04C3	USER_DATA 20	20th User Data	R/W

The user map can be read and written at the addresses 1200 ~ 1219 by mapping the desired data to addresses 721 ~ 740. The data to be connected to addresses 721 ~ 740 are the values of data D-register at the addresses 0 ~ 999. For example, when you want to connect addresses 1200 (0=NPV), 1201 address (1=NSV), 1202 (5=MVOUT), 1203 (207=AT), 1204 (210=1.P), 1205 (211=1.C), 1206 (212=1.D), set the user map as follows.

Address		D-register		Parameter		Address		D-register	
DEC	HEX	DEC	HEX			DEC	HEX	DEC	HEX
40722	9F12	<b>721</b>	02D1	<b>0</b>	NPV	41201	A0F1	<b>1200</b>	04B0
40723	9F13	<b>722</b>	02D2	<b>1</b>	NSV	41202	A0F2	<b>1201</b>	04B1
40724	9F14	<b>723</b>	02D3	<b>5</b>	MVOUT	41203	A0F3	<b>1202</b>	04B2
40725	9F15	<b>724</b>	02D4	<b>207</b>	AT	41204	A0F4	<b>1203</b>	04B3
40726	9F16	<b>725</b>	02D5	<b>210</b>	1.P	41205	A0F5	<b>1204</b>	04B4
40727	9F17	<b>726</b>	02D6	<b>211</b>	1.I	41206	A0F6	<b>1205</b>	04B5
40728	9F18	<b>727</b>	02D7	<b>212</b>	1.D	41207	A0F7	<b>1206</b>	04B6

The user map set in this way can be read / written using the addresses 1200 ~ 1206.

◆ BIT Information

Bit	NOW_STS	ERR_STS	SUB_STS	ALM_STS	DI_STS
15		SYS.Err			
14		OPT.Err			
13		E2P.Err			
12		ADC.Err			
11		CAL.Err			
10		RJC.Err		HBA.M	
9		AT.Err		LBA.M	
8		COMM.Err			
7	LOCK	B.OUT			
6		+OVER			
5	STD/HC	-OVER			
4	RAMP				
3	REM		SUB4 OUT	AL4.M	DI4 IN
2	Auto/Manu		SUB3 OUT	AL3.M	DI3 IN
1	AT		SUB2 OUT	AL2.M	DI2 IN
0	RUN/STOP		SUB1 OUT	AL1.M	DI1 IN

- Now STS (Now Status) description

Bit	Description (0)	Description (1)
15		
14		
13		
12		
11		
10		
9		
8		
7	No lock	Lock set
6		
5	STD (heating control)	HC (heating / cooling control)
4	RAMP non-use	RAMP use
3	SV.NO use	REM use
2	AUTO OUTPUT	MANUAL OUTPUT
1	Normal	Running AT
0	STOP (monitoring)	RUN

- ERR\_STS (Error Status) description

Bit	Description (0)	Description (1)
15	Normal	System Code Error
14		Option Code Error
13		EEPROM Error
12		ADC Error
11		Calibration Error
10		RJC Error

9		Auto Tuning Error
8		Comunication Error
7		Burn Out
6		PV value +OVER
5		PV value -OVER
4		
3		
2		
1		
0		

- SUB\_STS (Sub Output Status) description

Bit	Description (0)	Description (1)	
15	Normal		
14			
13			
12			
11			
10			
9			
8			
7			
6			
5			
4			
3			SUB4 OUTPUT generation
2			SUB3 OUTPUT generation

1		SUB2 OUTPUT generation
0		SUB1 OUTPUT generation

- ALM\_STS (Alarm Status) description

Bit	Description (0)	Description (1)
15	Normal	
14		
13		
12		
11		
10		
9		
8		
7		
6		
5		
4		
3		
2		
1		
0		
		HBA generation
		LBA generation
		HBA generation
		LBA generation
		HBA generation
		LBA generation

- DI\_STS (Digital Input Status) description

Bit	Description (0)	Description (1)
15	Normal	
14		

13		
12		
11		
10		
9		
8		
7		
6		
5		
4		
3		DI4 IN
2		DI3 IN
1		DI2 IN
0		DI1 IN

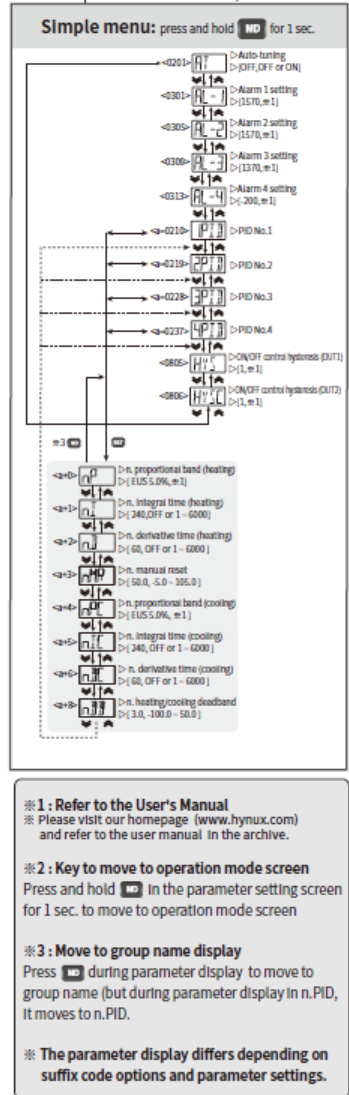
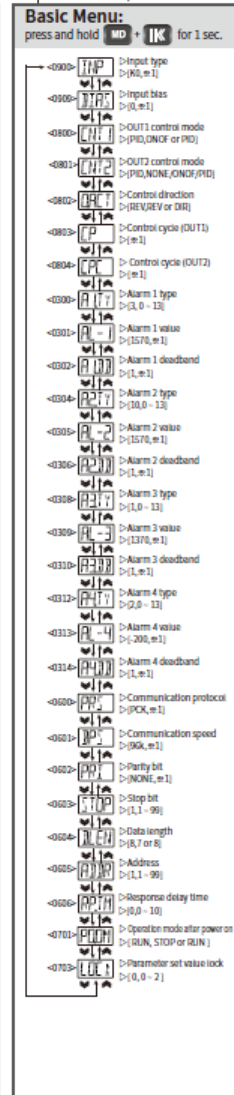
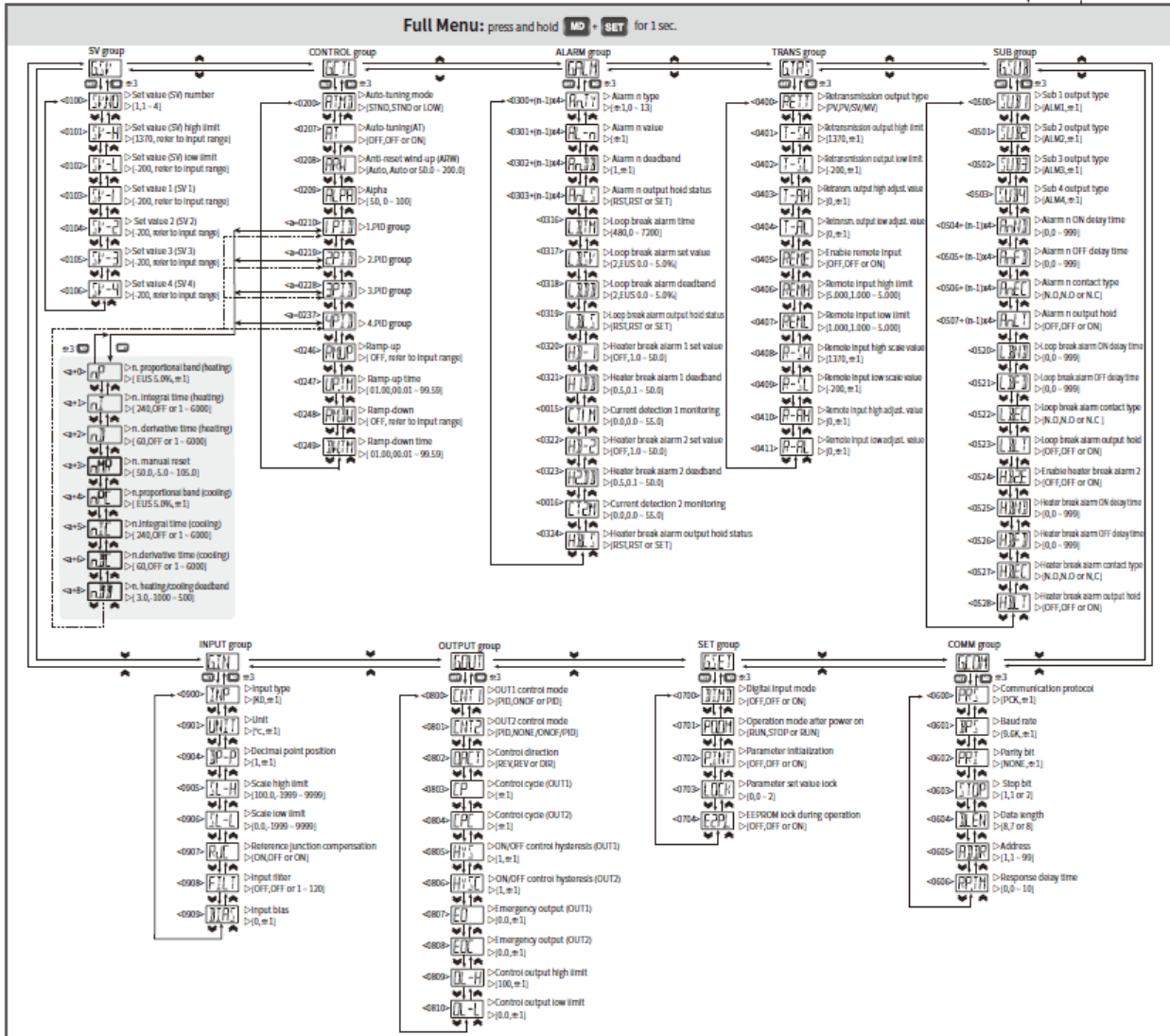
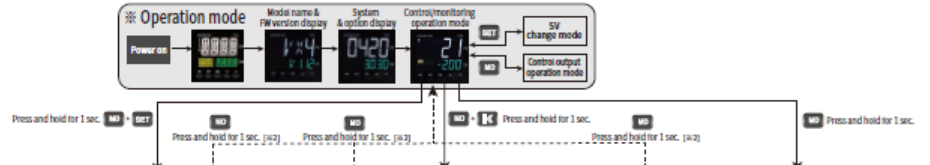
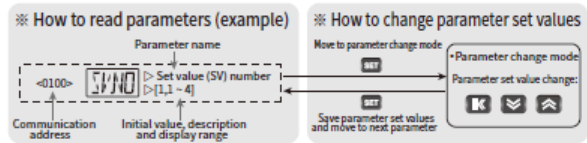

- ※ 1 : Refer to the User's Manual**  
Please visit our homepage ([www.hynux.com](http://www.hynux.com)) and refer to the user manual in the archive.
- ※ 2 : Key to move to operation mode screen**  
Press and hold [F1] + [F2] in the parameter setting screen for 1 sec. to move to operation mode screen
- ※ 3 : Move to group name display**  
Press [F1] during parameter display to move to group name (but during parameter display in n.PID, it moves to n.PID).
- ※ The parameter display differs depending on suffix code options and parameter settings.**



HANYOUNGNUX CO.,LTD

[www.hynux.com](http://www.hynux.com)