

ML-D SERIES

Module Type Temperature Control System

INSTRUCTION MANUAL



ABOUT THIS MANUAL

Thank you very much for purchasing HANYOUN NUX product. This instruction manual includes details of product functionality, installation method, cautions, usage, and others. Read and be fully aware of contents before use of product. Also, provide this manual in order for end user use, and at easily accessible place anytime.

- * Contents of this manual are subject to change without prior notice.
- * For questions, and errors regarding contents of this manual, contact our company or business offices.
- * Unpermitted reprinting and duplication of all or part of contents of this manual are strictly prohibited.

■ Services (A/S)

- * For A/S request of this company's product, please contact outlets, sales office nearby or head office of our company.
- * If you like onsite visit service, please send the request after speaking with A/S Center personnel on the phone.
- * Prior to sending request, please check if questions and answers for the same problems are posted in the FAQ section of homepage.

HANYOUNG NUX

28, Gilpa-ro 71 beon-gil, Nam-gu, Incheon, Korea

TEL : +82-32-876-4697 (main phone line)

FAX : +82-32-876-4696

URL : <http://www.hynux.com>

E-mail : overseas@hynux.com

TABLE OF CONTENTS

1. Before starting	1.1. Overview	2
	1.2. Product verification	3
	1.3. Safety cautions	4
2. Installation	2.1. Installation place and cautions	5
	2.2 Connection diagram	6
	2.3 Exterior dimension	8
	2.4 Power supply and communications interface(RS485/RS232C)	9
	2.5 Event output unit connections	11
3. Run	3.1 Protocol composition	12
	3.2 Register composition	18
	3.2.1 ML-D2H register composition	18
	3.2.2 ML-D2H register description	20
	3.2.3 ML-D4 register composition	25
	3.2.4 ML-D4 register description	27
	3.3 Manipulation and run	32
	3.3.1 Input section	32
	3.3.2 Control section	34
	3.3.3 Event section	40
	3.3.4 Status indication and set up	44
3.3.5 Warning occurrence and handling	47	
4. Specifications		48

Before starting

Installation

Operation

Specifications

1. BEFORE STARTING

1.1 Overview

■ ML Series product family

Multi-channel temperature control system (ML-D4, ML-D2H), event output (ML-E)

■ Module composition method (Individual product is called "Unit")

ML Series products can be made up as one module by connecting maximum of 31 units without wiring work, and only one Unit is connected to power cable and communications line (RS485). Event output (ML-E) is not included in maximum connection quantity, and only one Unit is connected during module composition and used.

■ Product run through communications connection

For RS232C and RS485 communications method, this product supports PC-Link, PC-Link with SUM, Modbus, ASCII/RTU protocols. Through individual communication with product, it is operated with reading/writing of Register address defined based on function. Basic functions such as control and monitoring can be tested or operated using operating program provided in the computer.

RS485 communications : For use, connect to communications terminal at low part, and this standard is used when operating multiple units since communications are achieved only through address set as switch in front side.

RS232C communications : For use, connect to Loader Jack at front part, and only connected unit is communicated regardless of front side switch setup. It is for unit's initial setting.

■ Input type

Thermocouple (12 types) : K, J, E, T, R, B, S, L, N, U, W, PL2

RTD (2 types) : Pt100, KPt100

DC voltage (3 types) : 0 - 10 V, 1 -5 V, 0 - 100 mV

Direct current (4 - 20 mA) : Set input type as direct current (1 -5 V), attach 250 Ω of electric resistance at both ends of input terminal.

Current Transformer (CT) : 2 channel, AC 1 - 50A (primary current measuring range), apply only to ML-D2H

■ Control output type

Depending on output type of model composition, fixed in one among REALY, voltage pulse (SSR), and current output (SCR).

■ Control method

2DOF (Degree of Freedom) PID control with auto tuning support, ON/OFF control

ML-D2H : 2 Channel, Standard control (Selectable Heating or cooling control) or Heating/Cooling simultaneous controlling



ML-D4 : 4 Channel, Standard control (Selectable Heating or cooling control)

■ Installation

Can attach onto panel by fixing in DIN 35 mm standard rail or using screw

1.2 Product verification

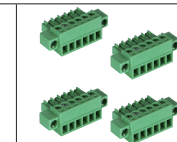
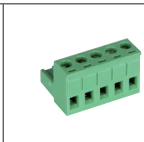
For product purchase, please first verify desired specifications, and then damages in exterior and parts insufficiency. And contact sales department of this company if found different specifications, exterior damage, or parts insufficiency.

				
Body	6-pin terminal 4 EA	5-pin terminal 1 EA	RS232C communications cable (optional)	Instruction manual

1.2.1 Model composition

■ Module type temperature controller (ML-D2H)

Model	Code		Details	
ML-D	2	H <input type="checkbox"/>	Module type temperature controller	
Number of channels	2		2 channel	
Function		H	Heating/cooling control (simultaneous), heater break alarm (HBA)	
Output type	MM	OUT1 (heating)	Relay output	
		OUT2 (cooling)		
	SM	OUT1 (heating)	SSR / SCR (4 -20 mA d.c.) parameter optional output	
		OUT2 (cooling)	Relay output	
	SS	OUT1 (heating)	SSR / SCR (4 -20 mA d.c.) parameter optional output	
		OUT2 (cooling)		

■ Module type temperature controller (ML-D4)

Model	Code		Details	
ML-D	<input type="checkbox"/>	<input type="checkbox"/>	Module type temperature control system	
Number of channels	4		4 channel	
Output type		M	Relay output	
		S	SSR output (12 V d.c.)	
		C	SCR output (4 -20 mA d.c.)	

Ex: Temperature control system 4 channel relay output : ML-D4M

■ Module type event output (ML-E)

Model	Code	Details	
ML-	E	Module type event output unit	

1.3. Safety Cautions

1.3.1 Cautions for safety

- For protection and safety of product and system connected to product, please use product according to safety instructions of this manual.
- The company will not be held responsible for all safety related issues and loss caused by carelessness and others, for use or treatment not following directions of instruction manual.
- For protection and safety of product and system connected to product, if required to install additional safety circuit and others, please make sure to install on external side of this product.
- Do not disassemble, repair, and renovate at self discretion, as it may cause product damage and malfunctions.
- Do not give shock to product, this can cause product damage or malfunction

1.3.2 Quality assurance

- Unless specified in terms of quality assurance of this company, no guarantee or compensation will be provided for this product.
- If damage is caused to user or third party due to defects and inevitable accidents that are impossible to predict by this company, the company, on any occasion, will not be responsible for loss, indirect damages, and others

1.3.3 About quality assurance terms of this product

- Product warranty period is one year from purchase date of this product, and for breakdowns occurred during normal usage according to this instruction manual, free repair service will be provided for such product only.
- For repair to breakdowns occurred after warranty expiration of this product, it will be repaired at cost (actual expense), based on company specified guidelines.
- For problems below, repairs will be provided at cost even for breakdown during warranty repair period.
 - Breakdown due to user's fault
 - Breakdown due to natural disasters
 - Breakdown due to transfer and others after product installation
 - Breakdown due to improper product modifications or losses
 - Breakdown due to power supply problem such as power supply instability
- If A/S is required due to breakdown and others, please contact purchase outlet and our company sales department.

2. Installation

2.1 Installation place and cautions

2.1.1 Installation place

- To avoid risk of electric shock, use after panel penel is installed to this product.
- Do not install product at following places.
 - Place that people can come into contact with terminal without awareness.
 - Place directly exposed to mechanical vibrations or shocks
 - Place exposed to corrosive gas or combustible gas
 - Place with large change of temperatures
 - Place with overly high temperature or low temperature
 - Place exposed with direct sun light
 - Place greatly influenced by electronic wave
 - Place high in humidity
 - Place with combustible items in surroundings in the event of fire
 - Place with a lot of dust or salinity

2.1.2 Caution

- In case of wiring, cut off power sources of all instruments before start of wiring work
- This product operates at DC24 V. There is danger of electric shocks and fire if other than rated power supply is used.
- To use ML Series as one module by connecting several units, connect power to only one unit.
- When connecting DC 24 V power source, use rated power supply by calculating total power consumption of module to use. Using power supply less than total power consumption of module can cause abnormal run and malfunction.
- Do not operate with wet hands as there is risk of electric shocks.
- For installation and usage, follow directions specified in instruction manual.
- Do not supply power before connection for devices of this product is completed.
- Do not block heat opening of this product as it can cause breakdown.
- Make sure not to touch terminal when current is flowing as there is risk of electric shock.

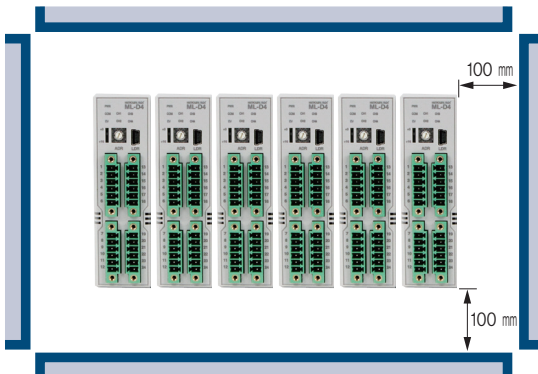

- For module body installation or separation, please secure proper interval of over 100 mm considering communications terminal connector and others.

2.2 Connection diagram

2.2.1 Name of each part

■ ML-D2H

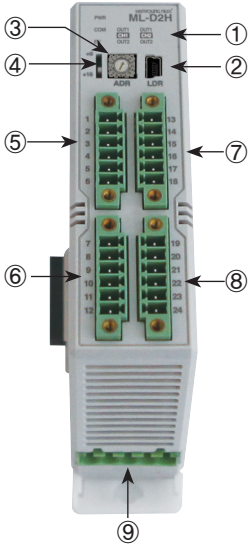

No.	Name	Function
①	Status indication LED	Power supply, communication, event, control output, heater break event indication
②	Loader Jack	RS232C communication input terminal
③	Unit address switch	RS485 communication address setting switch (0~15)
④	Unit extension address switch	RS485 communication extension address setting switch (0 /+16)
⑤	CH 1 terminal	Temperature input and current transformer (CT) input terminal
⑥		OUT 1: heating control output terminal OUT 2: cooling control output terminal
⑦	CH 2 terminal	Temperature input and current transformer (CT) input terminal
⑧		OUT 1: heating control output terminal OUT 2: cooling control output terminal
⑨	Power source and communications terminal	RS485 communications and 24 V d.c. input terminal

※ If unit extension address switch is positioned at "+16" and unit address switch is positioned at "1," RS485 communications address is set to "1+16=17."

■ ML-D4

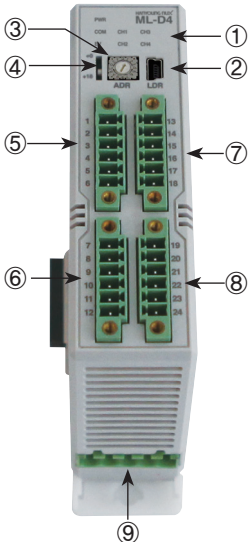

No.	Name	Function
①	Status indication LED	Power supply, communication, event, control output indication
②	Loader Jack	RS232C communication input terminal
③	Unit address switch	RS485 communication address setting switch (0~15)
④	Unit extension address switch	RS485 communication extension address setting switch (0 /+16)
⑤	CH 1 terminal	Input signal (sensor) Temperature input and control output terminal
⑥	CH 2 terminal	
⑦	CH 3 terminal	
⑧	CH 4 terminal	
⑨	Power supply and communications terminal	RS485 communications and 24 V d.c. input terminal

※ If unit extension address switch is positioned at "+16" and unit address switch is positioned at "1," RS485 communications address is set to "1+16=17."

2.2.2 Connection method



Caution

- Before connecting devices, make sure that current is not flowing through connection cable by cutting off voltage to all instruments to be supplied with power
- As there is danger of electric shock while current is flowing, make sure not to touch terminal.
- Make sure to connect after disconnecting power source voltage.
- For users, do not touch other than above mentioned terminals here.

● ML-D2H

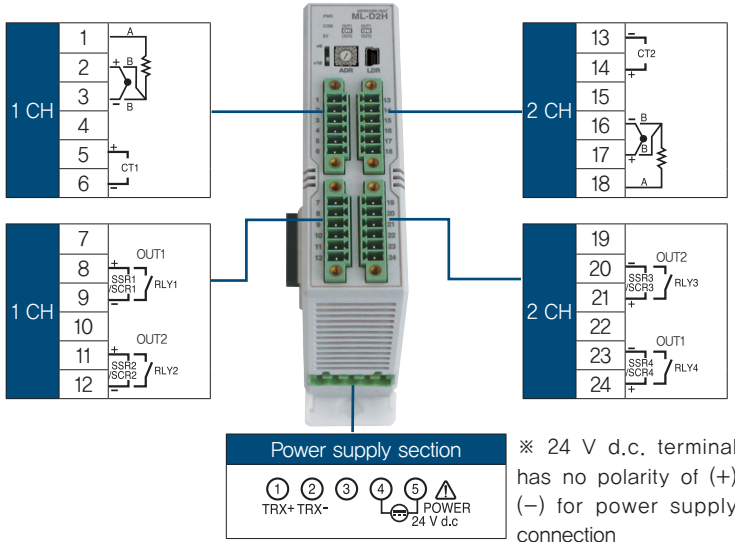

● ML-D4

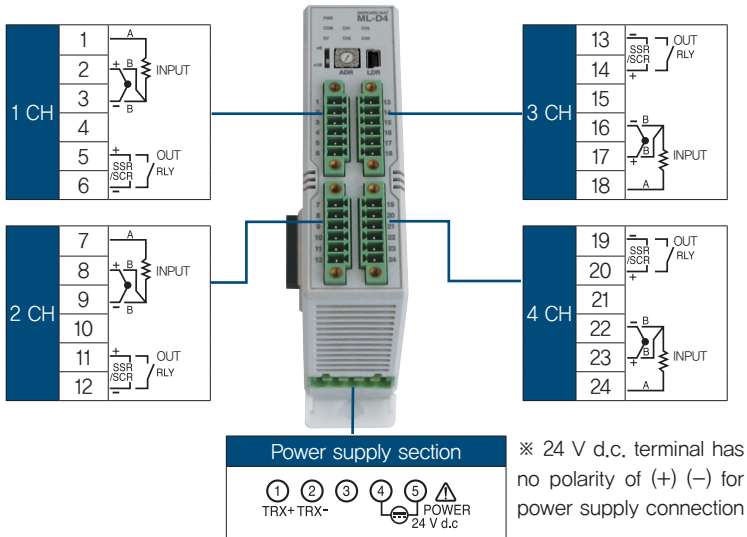

● ML-E

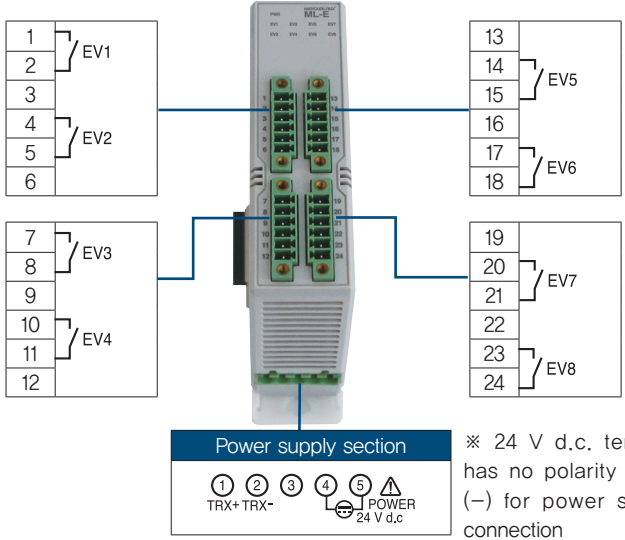

2.3 Exterior dimension

Unit : mm

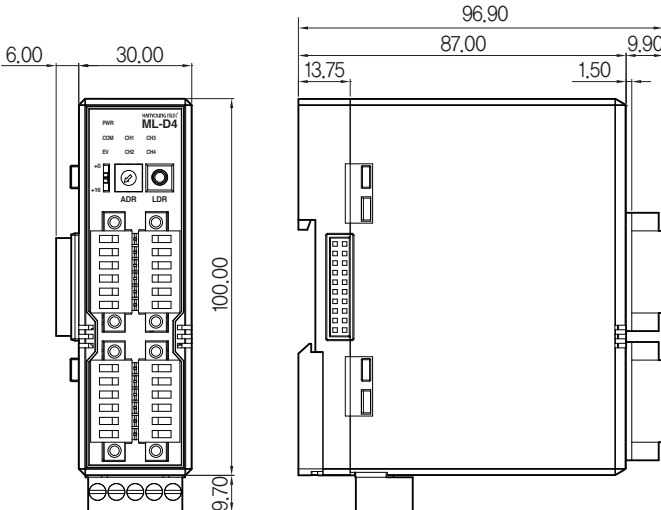

※ The dimensions of ML-D2H and ML-D4 are same

2.4 Power supply and communications interface (RS485/RS232C)

2.4.1 Power supply and communications interface

- When using ML Series as one module by connecting several units, supply power cable and communications line to only one unit. Required maximum power capacity is 32 units X 7 W= 224 W when making up 32 unit module. (Refer to power supply specification)

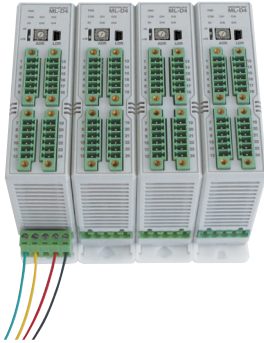

(Example of proper use)

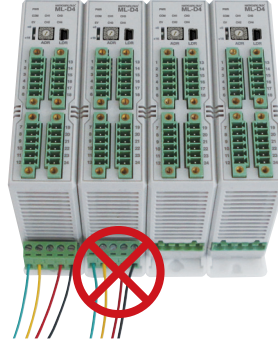

(Example of incorrect use)

- 2 wire type communication and power source connection

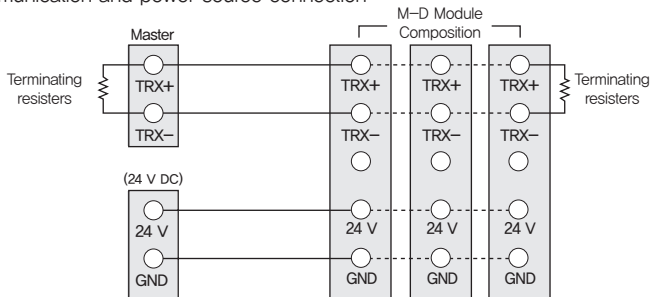

※ Dotted line is connected automatically during module composition.

- 4 wire type communication and power source connection

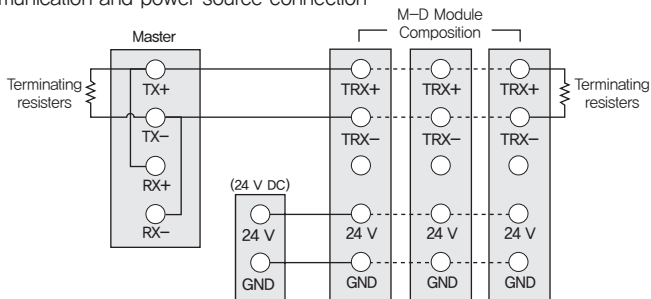

※ Dotted line is connected automatically during module composition.

2.4.2 RS232C communication

RS232C communication is used to control one Unit, and communicates only with Loader Jack. For RS232C communication, despite Address setting switch, automatic setup is provided such as communications Address "1", protocol "PC-LINK", communication speed "9,600bps", start bit "1 bit", data length "8 bit", parity bit "even number", stop bit "1 bit." Even with RS232C communication, remote control and monitoring of connected unit is possible.



2.4.3 RS485 communication

Individual control is also possible using RS485 communication with unit address set as Unit Address switch. Unit address setting is possible from No. 1 to No. 31. For setting below address No. 15, unit address switch is set from No. 1 to No. 15 with unit address extension switch "+0" and for setting address over No. 15, unit address switch No. 0 to No. 15 is set with unit extension switch positioned at "+16". If unit extension switch is positioned at "+16" and unit address switch at "1", RS485 communication address is set as "1+16=17".

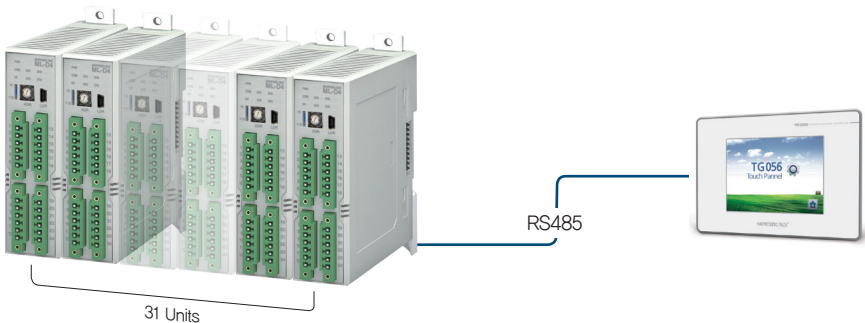

2.5 Event output unit (ML-E) connections

- ML-E has no communications address, and sends output by receiving signal with side connector during module composition.

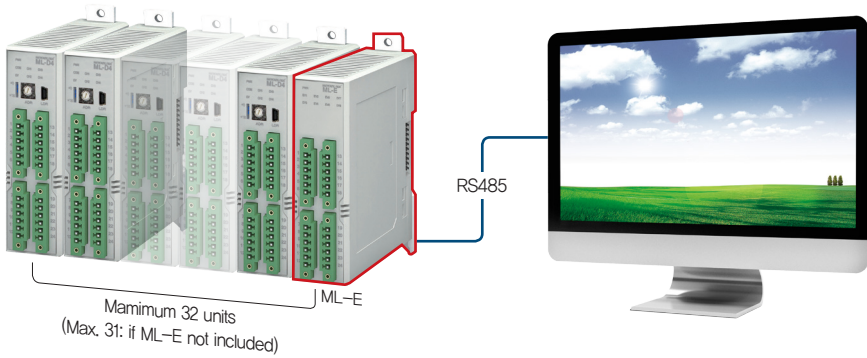

- ML-E can be located and connected anywhere during module composition.

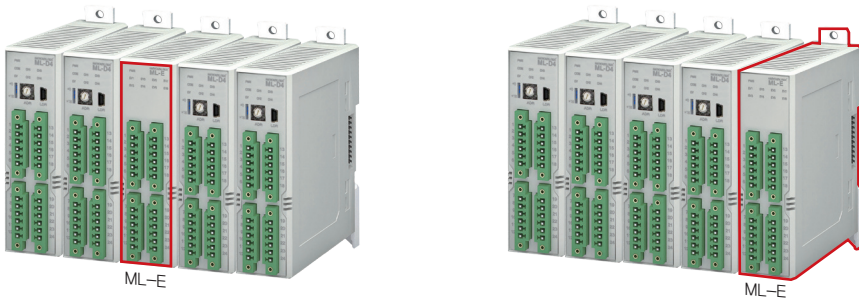

- When making up as one module, only 1 unit should be connected.
If several units of ML-E need to be used, it can be achieved by connecting power supply cable and communication line with wiring method, instead of side connector.

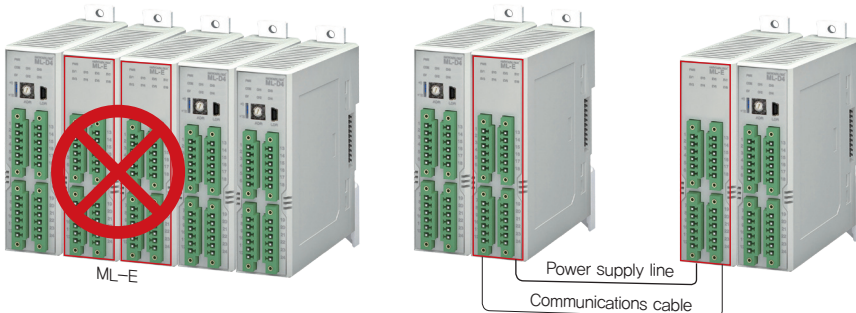

3. Run

3.1 Protocol composition

- Overview

- This product supports RS232C/485 communications, basic functions can be tested or operated such as control, monitoring, and others using operating program provided in the computer.
- Protocols supported include PC–Link, PC–Link with SUM, Modbus, ASCII, Modbus RTU.

3.1.1 PC–LINK protocol

- Communication of product is performed with ASC II character string, defined Register can be read and written.
(Frame structure)

STX	Address	Command	Data	CR	LF
STX	01 ~ 99	Refer to each Command		0x0D	0x0A

- Communications command

- This product uses following communication Command.

Command	Detail
D R S	D Register consecutive reading
D R R	D Register random reading
D W S	D Register consecutive writing
D W R	D Register random writing
W H O	Indication of own information

- Use of communication Command

(1) DRS Command

- Use when reading value of consecutive D Register
- On frame, enter number of data to be read and D Register number

(Transmission frame)

Byte size	1	2	3	1	2	1	4	1	1
Description	STX	Address	DRS	,	EA	,	D Register	CR	LF

* EA : 01~32

* D Register : start D Register

(Reception frame)

Byte size	1	2	3	1	2	1	4	1	...	1	4	1	1
Description	STX	Address	DRS	,	OK	,	Data(1)	,	...	,	Data(n)	CR	LF

* Data: Hexadecimal number Word data string

(2) DRR Command

- Use when reading random D Register value
- On frame, enter number of data to be read and D Register number on frame

(Transmission frame)

Byte size	1	2	3	1	2	1	4	1	...	1	4	1	1
Description	STX	Address	DRR	,	EA	,	D Register(1)	,	...	,	D Register(n)	CR	LF

* EA : 01~32

(Reception frame)

Byte size	1	2	3	1	2	1	4	1	...	1	4	1	1
Description	STX	Address	DRR	,	EA	,	D Register(1)	,	...	,	D Register(n)	CR	LF

* Data: Hexadecimal number Word data string

(3) DWS Command

- Use when writing series of D Register values
- On frame, enter number of data to write, D Register number and each data

(Transmission frame)

Byte size	1	2	3	1	2	1	4	1	4	1	...	1	4	1	1
Description	STX	Address	DWS	,	EA	,	D Register	,	Data(1)	,	...	,	Data(n)	CR	LF

* EA: 01~15

* D Register: start D Register

* Data: Hexadecimal number data string

(Reception frame)

Byte size	1	2	3	1	2	1	1	1
Description	STX	Address	DWS	,	OK	CR	LF	

(4) DWR Command

- Use when writing random D Register value
- On frame, enter number of data to write and D Register number and each data

(Transmission frame)

Byte size	1	2	3	1	2	1	4	1	4	1	...	1	4	1	4	1	1
Description	STX	Address	DWR	,	EA	,	D Register(1)	,	Data(1)	,	...	,	D Register(n)	,	Data(n)	CR	LF

* EA: 01~15

* Data: Hexadecimal number word data string

(Reception frame)

Byte size	1	2	3	1	2	1	1	1
Description	STX	Address	DWR	,	OK	CR	LF	

(5) WHO Command

– Can see product info, with WHO Command

〈Transmission frame〉

Byte size	1	2	3	1	1
Description	STX	Address	WHO	CR	LFA

Reception frame

Byte size	1	2	3	1	2	1	–	1	1
Description	STX	Address	WHO	,	OK	,	Name & Version	CR	LF

* – : Byte size changes depending on model name and version

(6) Reply at error

– When receiving Command, this product transmits reception frame proper to corresponding frame
However, if there is an error in reception Command, following NG Frame is transmitted.

〈Transmission frame〉

Byte size	1	2	3	1	2	2	1	1
Description	STX	Address	Command	,	NG	NG Code	CR	LF

– Details of NG Code are as follows

NG Code	Name	Details
0x01	Command	Not used Command
0x02	Register	Not used Register
0x03	Number	Number of communications and number of Data do not match
0x04	Data	Data is out of Hex (0x0 ~ 0xF)
0x08	Delim	Terminating string (CR, LF) error
0x10	SUM	Inconsistent SUM value
0x18	Over range	Value exceeding provided address scope
0x00	Misc	Others

3.1.2 PC-LINK with SUM protocol

– Protocol that CHECK SUM is added to PC-LINK Protocol

〈Frame structure〉

STX	Address	Command	Data	SUM	CR	LF
STX	01 ~ 99	Refer to each Command		Check SUM	0x0D	0x0A

- Check Sum is value generated by adding every 1 Byte of string ASCII code until SUM
- Convert generated value into 2 characters of Hexadecimal number

ex) STX 0 1 WH 0 4 F CR LF

$$\text{Check Sum} = 4F, \text{ Check Sum} = "0"(0x30) + "1"(0x31) + "W"(0x57) + "H"(0x48) + "O"(0x4F) \\ = 0x30 + 0x31 + 0x57 + 0x48 + 0x4F = 0x14F$$

As Check Sum is 1byte character, it becomes 0x4F, and then this changes to ASCII Code "4F."

3.1.3 MODBUS–RTU Protocol

- Frame structure

Frame heading character	Instrument no.	Function code	Data	Frame confirmation CRC	Frame terminating character
none	8 bit	8 bit	n x 8 bit	16 bit	None

CRC : Cyclic Redundancy Check

- Function code

Function code	Code detail
03	Register multiple reading (n EA)
06	Register single writing (1 EA)
08	Diagnosis function (LOOP–BACK TEST)
16	Register multiple writing (n EA)

- Function code 03 (READ MULTIPLE REGISTERS)

With function code 03, consecutive register details can be read at once. Number of data to be read at once varies depending on line condition and transmission speed within the frame. One transmission frame should be less than 255 bytes.

(Transmission frame)

Serial number	Details	Size	Ex.
0	Frame head character	None	–
1	Device number	8 bit	01 h
2	Function code (03)	8 bit	03 h
3	Reading start register (high)	8 bit	75 h
4	Reading start register (low)	8 bit	36 h
5	Number of data to be read (high)	8 bit	00 h
6	Number of data to be read (low)	8 bit	05 h
7	Frame confirmation CRC (low)	8 bit	XX h
8	Frame confirmation CRC (high)	8 bit	XX h
9	Frame terminating character	None	–

(Reception frame)

Serial number	Details	Size	Ex.
0	Frame head character	None	–
1	Device number	8 bit	01 h
2	Function code (03)	8 bit	06 h
3	Number of data read and transmitted	8 bit	dd h
4	Read data 1 (high)	8 bit	dd h
5	Read data 1 (low)	8 bit	dd h
...
n – 4	Read data n (high)	8 bit	dd h
n – 3	Read data n (low)	8 bit	dd h
n – 2	Frame confirmation CRC (low)	8 bit	XX h
n – 1	Frame confirmation CRC (high)	8 bit	XX h
n	Frame terminating character	None	...

● Function code 06 (WRITE SINGLE REGISTER)

With function code 06, details of one certain register can be recorded.

〈Transmission frame〉

Serial number	Details	Size	Ex.
0	Frame head character	None	–
1	Device number	8 bit	01 h
2	Function code (06)	8 bit	06 h
3	Record start register (high)	8 bit	75 h
4	Record start register (low)	8 bit	36 h
5	Recorded data (high)	8 bit	00 h
6	Recorded data (low)	8 bit	05 h
7	Frame confirmation CRC (low)	8 bit	XX h
8	Frame confirmation CRC (high)	8 bit	XX h
9	Frame terminating character	None	–

〈Reception frame〉

Serial number	Details	Size	Ex.
0	Frame head character	None	–
1	Device number	8 bit	01 h
2	Function code (06)	8 bit	06 h
3	Record start register (high)	8 bit	dd h
4	Record start register (low)	8 bit	dd h
5	Recorded data (high)	8 bit	dd h
6	Recorded data (low)	8 bit	dd h
7	Frame confirmation CRC (low)	8 bit	xx h
8	Frame confirmation CRC (high)	8 bit	xx h
9	Frame terminating character	None	–

● Function code 08 (LOOP-BACK TEST)

With function code 08, self diagnosis test can be performed.

〈Transmission frame〉

Serial number	Details	Size	Ex.
0	Frame head character	None	–
1	Device number	8 bit	01 h
2	Function code (08)	8 bit	08 h
3	Diagnosis code (high)	8 bit	00 h
4	Diagnosis code (low)	8 bit	01 h
5	Transmission data (high)	8 bit	12 h
6	Transmission data (high)	8 bit	34 h
7	Frame confirmation CRC (low)	8 bit	XX h
8	Frame confirmation CRC (high)	8 bit	XX h
9	Frame terminating character	None	...

(Reception frame)

Serial number	Details	Size	Ex.
0	Frame head character	None	...
1	Device number	8 bit	01 h
2	Function code (08)	8 bit	08 h
3	Diagnosis code (high)	8 bit	00 h
4	Diagnosis code (low)	8 bit	01 h
5	Transmission data (high)	8 bit	12 h
6	Transmission data (high)	8 bit	34 h
7	Frame confirmation CRC (low)	8 bit	XX h
8	Frame confirmation CRC (high)	8 bit	XX h
9	Frame terminating character	None	...

● Function code 16 (WRITE MULTIPLE REGISTER)

With function code 16, consecutive register details can be written. Number of data to be written at a time is depending on line condition and transmission speed within the frame. One transmission frame should be less than 255 bytes.

(Transmission frame)

Serial number	Details	Size	Ex.
0	Frame head character	None	...
1	Device number	8 bit	01 h
2	Function code (16)	8 bit	10 h
3	Record start register (high)	8 bit	75 h
4	Record start register (low)	8 bit	36 h
5	Number of data to record (high)	8 bit	00 h
6	Number of data to record (high)	8 bit	05 h
7	Number of data to transmit (WORD)	8 bit	05 h
8	Data to record 1 (high)	8 bit	dd h
9	Data to record 1 (low)	8 bit	dd h
...
n - 4	Data to record n (high)	8 bit	dd h
n - 3	Data to record n (low)	8 bit	dd h
n - 2	Frame confirmation CRC (low)	8 bit	XX h
n - 1	Frame confirmation CRC (high)	8 bit	XX h
n	Frame terminating character	None	...

(Reception frame)

Serial number	Details	Size	Ex.
0	Frame head character	None	...
1	Device number	8 bit	01 h
2	Function code (16)	8 bit	10 h
3	Record start register (high)	8 bit	75 h
4	Record start register (low)	8 bit	36 h
5	Number of data recorded (high)	8 bit	00 h
6	Number of data recorded (high)	8 bit	05 h
7	Frame confirmation CRC (low)	8 bit	XX h
8	Frame confirmation CRC (high)	8 bit	XX h
9	Frame terminating character	None	...

3.2. Register composition

3.2.1 ML–D2H Register composition

No.	0	Description	+100	+200	Description by channel
0	–	–	–	–	–
1	PV.1	Process value	PV.1	PV.2	Process value
2	PV.2		SV.1	SV.2	Set value
3	–	–	MV.1	MV.2	Manipulated value
4	–	–	CHSTS.1	CHSTS.2	Channel status
5	–	–	EVSTS.1	EVSTS.2	Event status
6	SV.1	Set value	OUTSTS.1	OUTSTS.2	Heating control output status
7	SV.2		RJC.1	RJC.2	Reference junction compensation
8	–	–	TC.1	TC.2	sensor value
9	–	–	INP.1	INP.2	Input type
10	–	–	CHMD.1	CHMD.2	Channel mode
11	MV.1	Manipulated value	AT.1	AT.2	Auto tuning
12	MV.2		OUT.1	OUT.2	Output type
13	–	–	OUTS.1	OUTS.2	SSR/SCR output setting
14	–	–	OUT_C_STS.1	OUT_C_STS.2	Cooling control output status
15	–	–	–	–	–
16	CHSTS.1	Channel status	–	–	–
17	CHSTS.2		–	–	–
18	–	–	–	–	–
19	–	–	–	–	–
20	–	–	–	–	–
21	TSV.1	Current target set value	EV.1TY.1	EV.1TY.2	Event channel 1 setting
22	TSV.2		EV.1VL.1	EV.1VL.2	
23	–	–	EV.1HY.1	EV.1HY.2	Event channel 2 setting
24	–	–	EV.2TY.1	EV.2TY.2	
25	–	–	EV.2VL.1	EV.2VL.2	Event channel 3 setting
26	EVT_STS	Event status	EV.2HY.1	EV.2HY.2	
27	EVBUS_STS	Event output status	EV.3TY.1	EV.3TY.2	Event channel 4 setting
28	–	–	EV.3VL.1	EV.3VL.2	
29	–	–	EV.3HY.1	EV.3HY.2	Event channel 5 setting
30	–	–	EV.4TY.1	EV.4TY.2	
31	LOCK	Parameter setting lock	EV.4VL.1	EV.4VL.2	Event channel 6 setting
32	COMCHK	Time setting for RS485 communication disconnection detection time	EV.4HY.1	EV.4HY.2	
33	PARA_SAVE	Save parameter when communicating	EV.5TY.1	EV.5TY.2	Event channel 7 setting
34	PARA_COPY	Run parameter save	EV.5VL.1	EV.5VL.2	
35	–	–	EV.5HY.1	EV.5HY.2	Event channel 8 setting
36	CHMD.1	Channel mode	EV.6TY.1	EV.6TY.2	
37	CHMD.2		EV.6VL.1	EV.6VL.2	
38	–	–	EV.6HY.1	EV.6HY.2	Event channel 9 setting
39	–	–	EV.7TY.1	EV.7TY.2	
40	–	–	EV.7VL.1	EV.7VL.2	Event channel 10 setting
41	AT.1	Auto tuning	EV.7HY.1	EV.7HY.2	
42	AT.2		EV.8TY.1	EV.8TY.2	
43	–	–	EV.8VL.1	EV.8VL.2	Event channel 11 setting
44	–	–	EV.8HY.1	EV.8HY.2	
45	–	–	LBA.1	LBA.2	Loop break time setting
46	R/S	RUN/STOP	LBD.1	LBD.2	Loop break dead band setting

No.	0	Description	+100	+200	Description by channel
47	R/S_SAVE	Power outage recovery setting	EVSTOP.1	EVSTOP.2	Stop Running at event occurrence
48	PARA_INIT	Parameter initialization	HBC.1	HBC.2	Heater break current value
49	-	-	HBA.1	HBA.2	Heater break event current value
50	-	-	HB_HYS.1	HB_HYS.2	Heater break hysteresis
51	-	-	PB.1	PB.2	Heating control Proportional band value
52	-	-	TI.1	TI.2	Heating control Integral time value
53	-	-	TD.1	TD.2	Heating control Derivative time value
54	-	-	AP.1	AP.2	ALPH value
55	-	-	MR.1	MR.2	Manual reset
56	-	-	CT.1	CT.2	Heating control cycle time
57	-	-	PO.1	PO.2	Heating control emergency output
58	-	-	HYS.1	HYS.2	ON/OFF heating control hysteresis
59	-	-	RO.1	RO.2	Heating control stop / output when monitor
60	-	-	RUP.1	RUP.2	SV increase temperature
61	EVSTS.1	Event status by channel	RDN.1	RDN.2	SV decrease temperature
62	EVSTS.2		RMIN.1	RMIN.2	SV change time (minute)
63	-		RHRS.1	RHRS.2	SV change time (hour)
64	-	-	DR.1	DR.2	Control output
65	-	-	OHL.1	OHL.2	Output high limit
66	EV.1STS	Channel status by event	OLL.1	OLL.2	Auto tuning hysteresis
67	EV.2STS		AT_HYS.1	AT_HYS.2	Auto tuning hysteresis
68	EV.3STS		-	-	-
69	EV.4STS		-	-	-
70	EV.5STS		-	-	-
71	EV.6STS		BS.1	BS.2	Input compensation
72	EV.7STS		FL.1	FL.2	Input filter
73	EV.8STS		SVH.1	SVH.2	SV High setting
74	-	-	SVL.1	SVL.2	SV low setting
75	-	-	FRH.1	FRH.2	Input high limit
76	EVBUS.1	Event bus output setting	FRL.1	FRL.2	Input low limit
77	EVBUS.2		SLH.1	SLH.2	High scale limit
78	EVBUS.3		SLL.1	SLL.2	Low scale limit
79	EVBUS.4		DOT.1	DOT.2	Set decimal point
80	EVBUS.5		-	-	-
81	EVBUS.6		PBC.1	PBC.2	Cooling control Proportional band value
82	EVBUS.7		TIC.1	TIC.2	Integral time value
83	EVBUS.8		TDC.1	TDC.2	Cooling control Derivative time value
84	-	-	CTC.1	CTC.2	Cooling control cycle time
85	-	-	POC.1	POC.2	Cooling control output at emergency situation
86	PRS	Communication protocol	HYSC.1	HYSC.2	ON/OFF cooling control hysteresis
87	BPS	Transmission speed	ROC.1	ROC.2	Cooling control stop. Output at monitoring situation
88	PRI	Parity bit	-	-	-
89	STP	Stop bit	-	-	-
90	DLN	Data length	-	-	-
91	RPT	Delay time	HC.1	HC.2	Standard, heating/cooling control setting
92	-	-	HC_DB.1	HC_DB.2	Heating/cooling control deadband
93	-	-	-	-	-
94	-	-	-	-	-
95	ADDR	Switch address	-	-	-
96	MAX_CH	Number of channels	-	-	-
97	R_SYS	System data	-	-	-
98	R_OPT	Option date	-	-	-
99	ROMVER	Version	-	-	-

3.2.2 ML–D2H register description

Register range	Details
40001(0) ~ 40099(63)	CH1~2 PV, SV, MV, TSV, CHSTS, EVSTS and common channel setting
40101(65) ~ 40199(C7)	CH1 related setting
40201(C9) ~ 40299(12B)	CH2 related setting

※ Please use address 40000 for Modbus communication

Register address (HEX)		Symbol	Description	Property (R/W)	Setting range	Unit	Initial value
CH1	CH2	n : Number of channel					
1(1)	2(2)	PV	Process value	R	EU(0 ~ 100%)	℃	–
6(6)	7(7)	SV	Set value	R/W	EU (0 ~ 100%)	℃	EU (0%)
11(B)	12(C)	MV	Manipulated Value	R	0.0 ~ 100.0	%	–
16(10)	17(11)	CHSTS	Channel status	R	OR run for situation occurrence 15 Bit: Set "1" at System Data error 14 Bit: Set "1" at Calibration Data error 13 Bit: Set "1" at input circuit error 12 Bit: Set "1" at EEPROM error 11 Bit: Set "1" after 24 hours of Auto Tuning (AT) 10 Bit: Set "1" at standard contact point correction (RCJ) error 9 Bit: Set "1" when exceeding ±5% input range 8 Bit: Set "1" at input sensor error (B. OUT) 2 Bit: Set "1" at Auto Tuning (AT) running 1 Bit: Set "1" at monitor mode 0 Bit: Set "1" at run start	ABS	–
21(15)	22(16)	TSV	Target set value	R	EU (0 ~ 100%)	℃	EU (0%)
	26(1A)	EVT_STS	Event status	R	Indication of occurrence to all events previously set 0: no event occurred 1: event occurred	ABS	–
	27(1B)	EBUS_STS	Event Bus output status	R	Event bus output OR run 7 Bit(128): Set "1" at event bus8 output occurrence 6 Bit(64): Set "1" at event bus 7 output occurrence 5 Bit(32): Set "1" at event bus 6 output occurrence 4 Bit(16): Set "1" at event bus 5 output occurrence 3 Bit(8): Set "1" at event bus 4 output occurrence 2 Bit(4): Set "1" at event bus 3 output occurrence 1 Bit(2): Set "1" at event bus 2 output occurrence 0 Bit(1): Set "1" at event bus 1 output occurrence	ABS	–
	31(1F)	LOCK	Parameter change lock	R/W	0: possible to edit all parameters 1: possible to edit only SV, R/S, AT, CHEN parameters 2: impossible to edit all parameters	ABS	0
	32(20)	COMCHK	Time setting for RS485 communication disconnection detection time	R/W	0 : OFF 1 ~ 3,600	sec.	0 (OFF)
	33(21)	PARA_SAVE	Setting of communication used parameter save	R/W	0: Automatic parameter save 1: save manually using PARA_COPY parameter	ABS	0
	34(22)	PARA_COPY	Run parameter save	R/W	1: When PARA_SAVE "1" is set, save parameters manually	ABS	0
36(24)	37(25)	CHMD.n	Set channel mode	R/W	0: Stop mode 1: Monitor mode 2: Run mode	ABS	0
41(29)	42(2A)	AT.n	Run PID Auto Tuning (AT)	R/W	0: PID Auto Tuning (AT) stop 1: PID Auto Tuning (AT) start	ABS	0
	46(2E)	R/S	Run setting	R/W	0: run stop (STOP) 1: run start (RUN)	ABS	0

Register address (HEX)		Symbol	Description	Property (R/W)	Setting range	Unit	Initial value
CH1	CH2	n : Number of channel					
47(2F)		R/S_SAVE	Power outage recovery setting	R/W	0: NO run return 1: run return	ABS	1
48(30)		PARA_INIT	Run parameter initialization	R/W	1: Parameter initialization	ABS	0
61(3D)	62(3E)	EVSTS	Event channel by channel, 1~8 status	R	All events OR running 7 Bit(128): Set "1" at event channel 8 occurrence 6 Bit(64): Set "1" at event channel 7 occurrence 5 Bit(32): Set "1" at event channel 6 occurrence 4 Bit(16): Set "1" at event channel 5 occurrence 3 Bit(8): Set "1" at event channel 4 occurrence 2 Bit(4): Set "1" at event channel 3 occurrence 1 Bit(2): Set "1" at event channel 2 occurrence 0 Bit(1): Set "1" at event channel 1 occurrence	ABS	-
66(42)		EV.1STS	Event channel 1, channel 1~4 status	R	All events OR run 1 Bit(2): Set "1" at CH2 event occurrence 0 Bit(1): Set "1" at CH1 event occurrence	ABS	-
67(43)		EV.2STS	Event channel 2, channel 1~4 status	R			
68(44)		EV.3STS	Event channel 3, channel 1~4 status	R			
69(45)		EV.4STS	Event channel 4, channel 1~4 status	R			
70(46)		EV.5STS	Event channel 5, channel 1~4 status	R			
71(47)		EV.6STS	Event channel 6, channel 1~4 status	R			
72(48)		EV.7STS	Event channel 7, channel 1~4 status	R			
73(49)		EV.8STS	Event channel 8, channel 1~4 status	R			
76(4C)		EVBUS,1	Event bus 1 output setting	R/W	Set corresponding event bus output option at event occurrence 0: output (OFF) 1: output (ON)	ABS	0
77(4D)		EVBUS,2	Event bus 2 output setting	R/W			
78(4E)		EVBUS,3	Event bus 3 output setting	R/W			
79(4F)		EVBUS,4	Event bus 4 output setting	R/W			
80(50)		EVBUS,5	Event bus 5 output setting	R/W			
81(51)		EVBUS,6	Event bus 6 output setting	R/W			
82(52)		EVBUS,7	Event bus 7 output setting	R/W			
83(53)		EVBUS,8	Event bus 8 output setting	R/W			
86(56)		PRS	Communication protocol	R/W	0 : PC-LINK 1 : PC-LINK with SUM 2 : Modbus ASCII 3 : Modbus RTU	ABS	0 (PC-LINK)
87(57)		BPS	Transmission speed	R/W	0 : 9600 bps 1 : 19200 bps 2 : 38400 bps 3 : 57600 bps 4 : 76800 bps	ABS	0 (9600 bps)
88(58)		PRI	Parity bit	R/W	0 : NONE 1 : ODD 2 : EVEN	ABS	2 (EVEN)
89(59)		STP	Stop bit	R/W	1 : 1 Bit 2 : 2 Bit	ABS	1 (1 Bit)
90(5A)		DLN	Data length	R/W	7 : 7 Bit 8 : 8 Bit	ABS	8 (8 Bit)
91(5B)		RPT	Communication response delay	R/W	0~10 delay time= process time (maximum 25ms) +RTP X 10ms	ABS	0
95(5F)		ADDR	Communication setup Address	R	1 ~ 32	ABS	-
96(60)		MAX_CH	Number of channels	R	2 : 2 Channel	ABS	-

Register address (HEX)		Symbol	Description	Property (R/W)	Setting range	Unit	Initial value
CH1	CH2	n : Number of channel					
97(61)		R_SYS	System data	R	–	ABS	–
98(62)		R_OPT	Option data	R	–	ABS	–
99(63)		ROMVER	Firmware version	R	–	ABS	–
101(65)	201(C9)	PV	Process value	R	EU (0 ~ 100%)	℃	–
102(66)	202(CA)	SV	Set value	R/W	EU (0 ~ 100%)	℃	EU (0%)
103(67)	203(CB)	MV	Manipulated Value	R	0.0 ~ 100.0	%	–
104 (68)	204 (CC)	CHSTS	Channel	R	All error status OR run 15 Bit: Set "1" at System Data error 14 Bit: Set "1" at Calibration Data error 13 Bit: Set "1" at input circuit error 12 Bit: Set "1" at EEPROM error 11 Bit: Set "1" after 24 hours of Auto Tuning (AT) 10 Bit: Set "1" at RJC 9 Bit: Set "1" when exceeding ±5% input range 8 Bit: Set "1" at input sensor error (B. OUT) 2 Bit: Set "1" at Auto Tuning (AT) run 1 Bit: Set "1" at monitor mode 0 Bit: Set "1" at run start	ABS	–
105 (69)	205 (CD)	EVSTS	Event channel by channel 1~8 status	R	All events OR run 7 Bit(128): Set "1" at event channel 8 occurrence 6 Bit(64): Set "1" at event channel 7 occurrence 5 Bit(32): Set "1" at event channel 6 occurrence 4 Bit(16): Set "1" at event channel 5 occurrence 3 Bit(8): Set "1" at event channel 4 occurrence 2 Bit(4): Set "1" at event channel 3 occurrence 1 Bit(2): Set "1" at event channel 2 occurrence 0 Bit(1): Set "1" at event channel 1 occurrence	ABS	–
106 (6A)	206 (CE)	OUTSTS	Output status	R	0: output (OFF) 1: output (ON)	ABS	–
107 (6B)	207 (CF)	RJC	RJC temperature value	R	EU (0 ~ 100%)	℃	–
108 (6C)	208 (D0)	TC	Thermo couple (TC) value	R	EU (0 ~ 100%)	℃	–
109 (6D)	209 (D1)	INP	Set input type	R/W	0~18: Thermo Couple (TC) 20~23: Resistance Temperature Detector (RTD) 30~32: Direct Current Voltage (DCV) * Refer to input type	ABS	1 (Thermo couple K Type)
110 (6E)	210 (D2)	CHMD	Set channel mode	R/W	0: Stop mode 1: Monitor mode 2: Run mode	ABS	0
111 (6F)	211 (D3)	AT	Run PID Auto Tuning(AT)	R/W	0: PID Auto Tuning (AT) stop 1: PID Auto Tuning (AT) start	ABS	0
112 (70)	212 (D4)	OUT	Output type	R	0 : OUT1 – RELAY, OUT2 – RELAY 1 : OUT1 – SSR/SCR, OUT2 – RELAY 2 : OUT1 – SSR/SCR, OUT2 – SSR/SCR	ABS	Follow product specs
113 (71)	213 (D5)	OUTS	SSR/SCR output setting	R/W	'0' setting for SSR, '1' setting for SCR 1 Bit(2): SSR/SCR output setting for OUT2 0 Bit(1): SSR/SCR output setting for OUT1	ABS	0
114 (72)	214 (D6)	OUT_C_STS	Cooling control output status	R	Output OFF Output ON	ABS	–

Register address (HEX)		Symbol	Description	Property (R/W)	Setting range	Unit	Initial value	
CH1	CH2	n : Number of channel						
121 (79)	221 (DD)	EV.1TY	Set event channel 1 type	R/W	None(OFF) 1: Deviation high limit 2: Deviation low limit 3: Deviation high/low limit 4: Within deviation scope 5: Deviation high limit (stand by) 6: Deviation low limit (stand by) 7: Deviation low/high limit (stand by) 8: Within deviation (stand by) 9: PV high limit 10: PV low limit 11: PV high limit (stand by) 12: PV low limit (stand by) 13: SV high limit 14: SV low limit 15: Loop break (LBA) 16: – 17: Run start (RUN) 18: Run/monitor mode (READY) 19: FAIL	ABS	0(OFF)	
122 (7A)	222 (DE)	EV.1VL	Event set value of event channel 1	R/W	EUS (0 ~ 100%)	EU (0 ~ 100%)	°C	–
123(7B)	223(DF)	EV.1HY	Event channel 1, event hysteresis	R/W	EUS (0 ~ 10%)		°C	–
124(7C) ~ 144(90)	224(E0) ~ 244(F4)	EV.2 ~ EV.8	Set event channel 2~8 event type, set value and hysteresis	R/W	Same as event channel 1			
145 (91)	245 (F5)	LBA	Set loop break event time	R/W	0(OFF), 1~7200		Sec.	0(OFF)
146 (92)	246 (F6)	LBD	Set loop break event dead band	R/W	EUS (0 ~ 100%)		°C	EUS (100%)
147 (93)	247 (F7)	EVSTOP	Set stop run at event occurrence	R/W	0: continuous run 1: stop run		ABS	0 (continuous run)
148 (94)	248 (F8)	HBC	Heater break current value	R	1~50A		A	–
149 (95)	249 (F9)	HBA	Heater break current value setting	R/W	0(OFF), 1.0~50.0A		A	0(OFF)
150 (96)	250 (FA)	HB_HYS	Heater break hysteresis setting	R/W	0.0~50.0		A	0.3
151 (97)	251 (FB)	PB	Set proportional band	R/W	EUS (0 ~ 100%)		°C	EUS (1%)
152 (98)	252 (FC)	TI	Set integral time	R/W	1 ~ 3600		Sec.	240
153 (99)	253 (FD)	TD	Set differentiation time	R/W	1 ~ 3600		Sec.	60
154 (9A)	254 (FE)	AR/AP	Heating control : Set 2DOF PID ALPHA Heating/Cooling control: Anti reset windup (ARW) setting	R/W	Heating control: 1~100 Heating/Cooling control: 0(AUTO), 50.0~200.0		ABS	0
155 (9B)	255 (FF)	MR	Set Manual Reset	R/W	0.0 ~ 100.0		%	0.0
156 (9C)	256 (100)	CT	Set control cycle time	R/W	1 ~ 100		Sec.	RELAY : 30 sec. SSR : 2 sec.
157 (9D)	257 (101)	PO	Set emergency output	R/W	0.0 ~ 100.0		%	0
158 (9E)	258 (102)	HYS	Set hysteresis at ON/OFF control	R/W	EUS (0 ~ 10%)		°C	EUS (0.2%)
159 (9F)	259 (103)	RO	Set output at stop, monitor status	R/W	0.0 ~ 100.0		%	0
160 (A0)	260 (104)	RUP	Set SV increase temperature at RAMP control	R/W	EUS (0 ~ 100%)		°C	EUS (0%)
161 (A1)	261 (105)	RDN	Set SV decrease temperature at RAMP control	R/W	EUS (0 ~ 100%)		°C	EUS (0%)
162 (A2)	262 (106)	RMIN	Set SV change time (min.) at RAMP control	R/W	0 ~ 1000		Min.	0

Register address (HEX)		Symbol	Description	Property (R/W)	Setting range	Unit	Initial value
CH1	CH2	n : Number of channel					
163 (A3)	263 (107)	RHRS	Set SV change time (hr.) at RAMP control	R/W	0 ~ 100	hour	0
164 (A4)	264 (108)	DR	Set control run	R/W	0: Reverse run (heating) control 1: Direct run (cooling) control	ABS	0
165 (A5)	265 (109)	OHL	Set high limit to Manipulated Value	R/W	0.0 ~ 100.0	%	100.0
166 (A6)	266 (10A)	OLL	Set low limit to Manipulated Value	R/W	0.0 ~ 100.0	%	0.0
171 (AB)	271 (10F)	BS	Set input correction	R/W	EUS (-100 ~ 100%)	℃	EUS (0%)
172 (AC)	272 (110)	FL	Set input filter	R/W	0 ~ 100	ABS	0
173 (AD)	273 (111)	SVH	Set SV high limit	R/W	EU (0 ~ 100%)	℃	EU (100%)
174 (AE)	274 (112)	SVL	Set SV low limit	R/W	EU (0 ~ 100%)	℃	EU (0%)
175 (AF)	275 (113)	FRH	Set PV high limit	R/W	EU (0 ~ 100%)	℃	EU (100%)
176 (B0)	276 (114)	FRL	Set PV low limit	R/W	EU (0 ~ 100%)	℃	EU (0%)
177 (B1)	277 (115)	SLH	Set scale high limit at DCV input setting	R/W	EU (0 ~ 100%)	mV	EU (100%)
178 (B2)	278 (116)	SLL	Set scale low limit at DCV input setting	R/W	EU (0 ~ 100%)	mV	EU (0%)
179 (B3)	279 (117)	DOT	Set decimal point	R/W	0 ~ 3 : decimal point digit	ABS	0
181 (B5)	281 (119)	PBC	Cooling control Proportional band setting	R/W	EUS (0 ~ 100%)	℃	EUS (2%)
182 (B6)	282 (1A0)	TIC	Cooling control integral time setting	R/W	1 ~ 3600	Second	240
183 (B7)	283 (1A1)	TDC	Cooling control derivative time setting	R/W	1 ~ 3600	Second	60
184 (B8)	284 (1A2)	CTC	Cooling control control period setting	R/W	1 ~ 100	Second	RELAY : 30 Sec. SSR : 2 Sec.
185 (B9)	285 (1A3)	POC	Cooling control Emergency output setting	R/W	0.0 ~ 100.0	%	0
186 (BA)	286 (1A4)	HYSC	Cooling control ON / OFF control Hysteresis setting	R/W	EUS (0 ~ 10%)	℃	EUS (0.2%)
187 (BB)	287 (1A5)	ROC	Stop cooling control. Output setting at monitor status	R/W	0.0 ~ 100.0	%	0
191 (BF)	291 (1A9)	HC	Standard , heating / cooling control settings	R/W	0 : heating control 1 : heating/cooling control	ABS	0 (heating control)
192 (C0)	292 (1AA)	HC_DB	Heating / cooling control dead band setting	R/W	-100 ~ 50	%	0

3.2.3 ML–D4 Register composition

No.	0	Description	+100	+200	+300	+400	Description by channel
0	–	–	–	–	–	–	–
1	PV.1	Process value	PV.1	PV.2	PV.3	PV.4	Process value
2	PV.2		SV.1	SV.2	SV.3	SV.4	Set value
3	PV.3		MV.1	MV.2	MV.3	MV.4	Manipulated Value
4	PV.4		CHSTS.1	CHSTS.2	CHSTS.3	CHSTS.4	Channel status
5	–	–	EVSTS.1	EVSTS.2	EVSTS.3	EVSTS.4	Event status
6	SV.1	Set value	OUTSTS.1	OUTSTS.2	OUTSTS.3	OUTSTS.4	control output status
7	SV.2		RJC.1	RJC.2	RJC.3	RJC.4	Temperature
8	SV.3		TC.1	TC.2	TC.3	TC.4	Sensor value
9	SV.4		INP.1	INP.2	INP.3	INP.4	Input type
10	–	–	CHMD.1	CHMD.2	CHMD.3	CHMD.4	Channel mode
11	MV.1	Manipulated Value	AT.1	AT.2	AT.3	AT.4	Auto tuning
12	MV.2		OUT.1	OUT.2	OUT.3	OUT.4	Output type
13	MV.3		EV.1DLY.1	EV.1DLY.2	EV.1DLY.3	EV.1DLY.4	Event 1 delay setting
14	MV.4		EV.2DLY.1	EV.2DLY.2	EV.2DLY.3	EV.2DLY.4	Event 2 delay setting
15	–	–	EV.3DLY.1	EV.3DLY.2	EV.3DLY.3	EV.3DLY.4	Event 3 delay setting
16	CHSTS.1	Channel status	EV.4DLY.1	EV.4DLY.2	EV.4DLY.3	EV.4DLY.4	Event 4 delay setting
17	CHSTS.2		EV.5DLY.1	EV.5DLY.2	EV.5DLY.3	EV.5DLY.4	Event 5 delay setting
18	CHSTS.3		EV.6DLY.1	EV.6DLY.2	EV.6DLY.3	EV.6DLY.4	Event 6 delay setting
19	CHSTS.4		EV.7DLY.1	EV.7DLY.2	EV.7DLY.3	EV.7DLY.4	Event 7 delay setting
20	–	–	EV.8DLY.1	EV.8DLY.2	EV.8DLY.3	EV.8DLY.4	Event 8 delay setting
21	TSV.1	Current target set value	EV.1TY.1	EV.1TY.2	EV.1TY.3	EV.1TY.4	Event 1 setting
22	TSV.2		EV.1VL.1	EV.1VL.2	EV.1VL.3	EV.1VL.4	
23	TSV.3		EV.1HY.1	EV.1HY.2	EV.1HY.3	EV.1HY.4	
24	TSV.4		EV.2TY.1	EV.2TY.2	EV.2TY.3	EV.2TY.4	
25	–	–	EV.2VL.1	EV.2VL.2	EV.2VL.3	EV.2VL.4	Event 2 setting
26	EVT_STS	Event status	EV.2HY.1	EV.2HY.2	EV.2HY.3	EV.2HY.4	Event 3 setting
27	EVBUS_STS	Event output status	EV.3TY1	EV.3TY2	EV.3TY3	EV.3TY4	
28	–	–	EV.3VL.1	EV.3VL.2	EV.3VL.3	EV.3VL.4	
29	–	–	EV.3HY.1	EV.3HY.2	EV.3HY.3	EV.3HY.4	Event 4 setting
30	–	–	EV.4TY.1	EV.4TY.2	EV.4TY.3	EV.4TY.4	
31	LOCK	Parameter setting lock	EV.4VL.1	EV.4VL.2	EV.4VL.3	EV.4VL.4	
32	COMCHK	Time setting for RS485 communication disconnection detection time	EV.4HY.1	EV.4HY.2	EV.4HY.3	EV.4HY.4	Event 5 setting
33	PARA_SAVE	Save parameter when communicating	EV.5TY.1	EV.5TY.2	EV.5TY.3	EV.5TY.4	
34	PARA_COPY	Run parameter save	EV.5VL.1	EV.5VL.2	EV.5VL.3	EV.5VL.4	Event 6 setting
35	–	–	EV.5HY.1	EV.5HY.2	EV.5HY.3	EV.5HY.4	
36	CHMD.1	Channel mode	EV.6TY.1	EV.6TY.2	EV.6TY.3	EV.6TY.4	
37	CHMD.2		EV.6VL.1	EV.6VL.2	EV.6VL.3	EV.6VL.4	
38	CHMD.3		EV.6HY.1	EV.6HY.2	EV.6HY.3	EV.6HY.4	
39	CHMD.4		EV.7TY.1	EV.7TY.2	EV.7TY.3	EV.7TY.4	
40	–	–	EV.7VL.1	EV.7VL.2	EV.7VL.3	EV.7VL.4	Event 7 setting
41	AT.1	Auto tuning	EV.7HY.1	EV.7HY.2	EV.7HY.3	EV.7HY.4	Event 8 setting
42	AT.2	Auto tuning	EV.8TY.1	EV.8TY.2	EV.8TY.3	EV.8TY.4	
43	AT.3		EV.8VL.1	EV.8VL.2	EV.8VL.3	EV.8VL.4	
44	AT.4		EV.8HY.1	EV.8HY.2	EV.8HY.3	EV.8HY.4	

Before starting

Installation

Operation

Specifications

No.	0	Description	+100	+200	+300	+400	Description by channel
45	–	–	LBA,1	LBA,2	LBA,3	LBA,4	Loop break event time
46	R/S	RUN/STOP	LBD,1	LBD,2	LBD,3	LBD,4	Loop break event dead band
47	R/S_SAVE	Power outage recovery setting	EVSTOP,1	EVSTOP,2	EVSTOP,3	EVSTOP,4	Stop running at event occurrence
48	PARA_INIT	Parameter initialization	–	–	–	–	–
49	–	–	–	–	–	–	–
50	–	–	–	–	–	–	–
51	–	–	PB,1	PB,2	PB,3	PB,4	Proportional band value
52	–	–	TI,1	TI,2	TI,3	TI,4	Integral time value
53	–	–	TD,1	TD,2	TD,3	TD,4	Derivative time value
54	–	–	AP,1	AP,2	AP,3	AP,4	ALPHA value
55	–	–	MR,1	MR,2	MR,3	MR,4	Manual reset
56	–	–	CT,1	CT,2	CT,3	CT,4	control cycle time
57	–	–	PO,1	PO,2	PO,3	PO,4	emergency output
58	–	–	HYS,1	HYS,2	HYS,3	HYS,4	hysteresis
59	–	–	RO,1	RO,2	RO,3	RO,4	Output at stop/monitor mode
60	–	–	RUP,1	RUP,2	RUP,3	RUP,4	SV increasing temperature
61	EVSTS,1	Event status by channel	RDN,1	RDN,2	RDN,3	RDN,4	SV decreasing temperature
62	EVSTS,2		RMIN,1	RMIN,2	RMIN,3	RMIN,4	SV increase and decrease time (minute)
63	EVSTS,3		RHRS,1	RHRS,2	RHRS,3	RHRS,4	SV increase and decrease time (hour)
64	EVSTS,4		DR,1	DR,2	DR,3	DR,4	Control run
65	–	–	OHL,1	OHL,2	OHL,3	OHL,4	Manipulated Value high limit
66	EV.1STS	Channel status by event	OLL,1	OLL,2	OLL,3	OLL,4	Manipulated Value low limit
67	EV.2STS		–	–	–	–	–
68	EV.3STS		–	–	–	–	–
69	EV.4STS		–	–	–	–	–
70	EV.5STS		–	–	–	–	–
71	EV.6STS		BS,1	BS,2	BS,3	BS,4	Input compensation
72	EV.7STS		FL,1	FL,2	FL,3	FL,4	Input filter
73	EV.8STS		SVH,1	SVH,2	SVH,3	SVH,4	High limit to setting
74	–	–	SVL,1	SVL,2	SVL,3	SVL,4	Low limit to setting
75	–	–	FRH,1	FRH,2	FRH,3	FRH,4	High limit to input
76	EVBUS,1	Event bus output	FRL,1	FRL,2	FRL,3	FRL,4	Low limit to input
77	EVBUS,2		SLH,1	SLH,2	SLH,3	SLH,4	High limit to scale
78	EVBUS,3		SLL,1	SLL,2	SLL,3	SLL,4	Low limit to scale
79	EVBUS,4		DOT,1	DOT,2	DOT,3	DOT,4	Decimal point
80	EVBUS,5		–	–	–	–	–
81	EVBUS,6		–	–	–	–	–
82	EVBUS,7		–	–	–	–	–
83	EVBUS,8		–	–	–	–	–
84	–	–	–	–	–	–	–
85	–	–	–	–	–	–	–
86	PRS	Communication protocol	–	–	–	–	–
87	BPS	Transmission speed	–	–	–	–	–
88	PRI	Parity bit	–	–	–	–	–
89	STP	Stop bit	–	–	–	–	–
90	DLN	Data length	–	–	–	–	–
91	RPT	Delay time	–	–	–	–	–
92	–	–	–	–	–	–	–
93	–	–	–	–	–	–	–
93	–	–	–	–	–	–	–
94	–	–	–	–	–	–	–

No.	0	Description	+100	+200	+300	+400	Description by channel
93	—	—	—	—	—	—	—
94	—	—	—	—	—	—	—
95	ADDR	Switch address	—	—	—	—	—
96	MAX_CH	Number of channels	—	—	—	—	—
97	R_SYS	System data	—	—	—	—	—
98	R_OPT	Option data	—	—	—	—	—
99	ROMVER	Version	—	—	—	—	—

3.2.4 ML–D4register description

Register address (HEX)	Description
40001(0) ~ 40099(63)	CH1~4 PV, SV, MV, TSV, CHSTS, EVSTS and common channel setting
40101(65) ~ 40199(C7)	CH1 related setting
40201(C9) ~ 40299(12B)	CH2 related setting
40301(12D) ~ 40399(18F)	CH3 related setting
40401(191) ~ 40499(1F3)	CH4 related setting

※ Please use address 40000 for Modbus communication

Register address (HEX)				Symbol	Description	Property (R/W)	Setting range	Unit	Initial value
CH1	CH2	CH3	CH4	n : Number of channel					
1(1)	2(2)	3(3)	4(4)	PV	Process value	R	EU(0 ~ 100%)	°C	—
6(6)	7(7)	8(8)	9(9)	SV	Set value	R/W	EU (0 ~ 100%)	°C	EU (0%)
11(B)	12(C)	13(D)	14(E)	MV	Manipulated Value	R	0.0 ~ 100.0	%	—
16(10)	17(11)	18(12)	19(13)	CHSTS	Channel status	R	OR run for situation occurrence 15 Bit: Set "1" at System Data error 14 Bit: Set "1" at Calibration Data error 13 Bit: Set "1" at input circuit error 12 Bit: Set "1" at EEPROM error 11 Bit: Set "1" after 24 hours of Auto Tuning (AT) 10 Bit: Set "1" at standard contact point correction (RCJ) error 9 Bit: Set "1" when exceeding ±5% input range 8 Bit: Set "1" at input sensor error (B. OUT) 2 Bit: Set "1" at Auto Tuning (AT) run 1 Bit: Set "1" at monitor mode 0 Bit: Set "1" at run start	ABS	—
21(15)	22(16)	23(17)	24(18)	TSV	Current target set value	R	EU (0 ~ 100%)	°C	EU (0%)
26(1A)				EVT_STS	Event status	R	Indication of occurrence to all events previously set 0: no event occurred 1: event occurred	ABS	—
27(1B)				EVBUS_STS	Event bus output status	R	Event bus output OR run 7 Bit(128): Set "1" at event bus8 output occurrence 6 Bit(64): Set "1" at event bus7 output occurrence 5 Bit(32): Set "1" at event bus6 output occurrence 4 Bit(16): Set "1" at event bus5 output occurrence 3 Bit(8): Set "1" at event bus4 output occurrence 2 Bit(4): Set "1" at event bus3 output occurrence 1 Bit(2): Set "1" at event bus2 output occurrence 0 Bit(1): Set "1" at event bus1 output occurrence	ABS	—
31(1F)				LOCK	Parameter setting lock	R/W	0: possible to edit all parameters 1: possible to edit only SV, R/S, AT, CHEN parameters 2: impossible to edit all parameters	ABS	0
32(20)				COMCHK	Time setting for RS485 communication disconnection detection time	R/W	0: OFF 1 ~ 3,600	second	0 (OFF)
33(21)				PARA_SAVE	Save parameter when communication	R/W	0: Automatic parameter save 1: save manually using PARA_COPY parameter	ABS	0

Register address (HEX)				Symbol	Description	Property (R/W)	Setting range	Unit	Initial value
CH1	CH2	CH3	CH4	n : Number of channel					
34(22)				PARA_COPY	Run parameter save	R/W	1: When PARA_SAVE "1" is set, save parameters manually	ABS	0
36(24)	37(25)	38(26)	39(27)	CHMD.n	Set channel mode	R/W	0: Stop mode 1: Monitor mode 2: Run mode	ABS	0
41(29)	42(2A)	43(2B)	44(2C)	AT.n	Run PID Auto Tuning (AT)	R/W	0: PID Auto Tuning (AT) stop 1: PID Auto Tuning (AT) start 2: PID Auto Tuning (AT) start. After AT is done, control is not start.	ABS	0
46(2E)				R/S	Run setting	R/W	0: run stop (STOP) 1: run start (RUN)	ABS	0
47(2F)				R/S_SAVE	Set power outage return	R/W	0: NO run return 1: run return	ABS	1 (Return to run)
48(30)				PARA_INIT	Run parameter initialization	R/W	1: Parameter initialization	ABS	0
61 (3D)	62 (3E)	63 (3F)	64 (40)	EVSTS	Event channel by channel, 1~8 status	R	All events OR run 7 Bit(128): Set "1" at event channel 8 occurrence 6 Bit(64): Set "1" at event channel 7 occurrence 5 Bit(32): Set "1" at event channel 6 occurrence 4 Bit(16): Set "1" at event channel 5 occurrence 3 Bit(8): Set "1" at event channel 4 occurrence 2 Bit(4): Set "1" at event channel 3 occurrence 1 Bit(2): Set "1" at event channel 2 occurrence 0 Bit(1): Set "1" at event channel 1 occurrence	ABS	—
66(42)				EV.1STS	Event channel 1, channel 1~4 status	R	All events OR run 3 Bit(8): Set "1" at CH4 event occurrence 2 Bit(4): Set "1" at CH3 event occurrence 1 Bit(2): Set "1" at CH2 event occurrence 0 Bit(1): Set "1" at CH1 event occurrence	ABS	—
67(43)				EV.2STS	Event channel 2, channel 1~4 status	R			
68(44)				EV.3STS	Event channel 3, channel 1~4 status	R			
69(45)				EV.4STS	Event channel 4, channel 1~4 status	R			
70(46)				EV.5STS	Event channel 5, channel 1~4 status	R			
71(47)				EV.6STS	Event channel 6, channel 1~4 status	R			
72(48)				EV.7STS	Event channel 7, channel 1~4 status	R			
73(49)				EV.8STS	Event channel 8, channel 1~4 status	R			
76(4C)				EVBUS.1	Event bus 1 output setting	R/W	Set corresponding event bus output option at event occurrence 0: output (OFF) 1: output (ON)	ABS	0
77(4D)				EVBUS.2	Event bus 2 output setting	R/W			
78(4E)				EVBUS.3	Event bus 3 output setting	R/W			
79(4F)				EVBUS.4	Event bus 4 output setting	R/W			
80(50)				EVBUS.5	Event bus 5 output setting	R/W			
81(51)				EVBUS.6	Event bus 6 output setting	R/W			
82(52)				EVBUS.7	Event bus 7 output setting	R/W			
83(53)				EVBUS.8	Event bus 8 output setting	R/W			

Register address (HEX)				Symbol	Description	Property (R/W)	Setting range	Unit	Initial value
CH1	CH2	CH3	CH4	n : Number of channel					
86(56)				PRS	Communication protocol	R/W	0 : PC-LINK 1 : PC-LINK with SUM 2 : Modbus ASCII 3 : Modbus RTU	ABS	0 (PC-LINK)
87(57)				BPS	Transmission speed (Bit per second)	R/W	0 : 9600 bps 1 : 19200 bps 2 : 38400 bps 3 : 57600 bps 4 : 76800 bps	ABS	0 (9600 bps)
88(58)				PRI	Parity bit	R/W	0 : NONE 1 : ODD 2 : EVEN	ABS	2 (EVEN)
89(59)				STP	Stop bit	R/W	1 : 1 Bit 2 : 2 Bit	ABS	1 (1 Bit)
90(5A)				DLN	Data length	R/W	7 : 7 Bit 8 : 8 Bit	ABS	8 (8 Bit)
91(5B)				RPT	Communication response delay	R/W	0~10 delay time= process time (maximum 25ms) +RTP X 10ms	ABS	0
95(5F)				ADDR	Communication setup Address	R	1 ~ 32	ABS	-
96(60)				MAX_CH	Number of channels	R	4 : 4 Channel	ABS	-
97(61)				R_SYS	System data	R	-	ABS	-
98(62)				R_OPT	Option data	R	-	ABS	-
99(63)				ROMVER	Firmware version	R	-	ABS	-
101 (65)	201 (C9)	301 (12D)	401 (191)	PV	Process value	R	EU (0 ~ 100%)	°C	-
102 (66)	202 (CA)	302 (12E)	402 (192)	SV	Set value	R/W	EU (0 ~ 100%)	°C	EU (0%)
103 (67)	203 (CB)	303 (12F)	403 (193)	MV	Manipulated Value	R	0.0 ~ 100.0	%	0
104 (68)	204 (CC)	304 (130)	404 (194)	CHSTS	Channel status	R	All error status OR run 15 Bit: Set "1" at System Data error 14 Bit: Set "1" at Calibration Data error 13 Bit: Set "1" at input circuit error 12 Bit: Set "1" at EEPROM error 11 Bit: Set "1" after 24 hours of Auto Tuning(AT) 10 Bit: Set "1" at standard contact point correction (RCU) error 9 Bit: Set "1" when exceeding ±5% input range 8 Bit: Set "1" at input sensor error (B. OUT) 2 Bit: Set "1" at Auto Tuning (AT) run 1 Bit: Set "1" at monitor mode 0 Bit: Set "1" at run start	ABS	-
105 (69)	205 (CD)	305 (131)	405 (195)	EVSTS	Event channel by channel 1~8 status	R	All events OR run 7 Bit(128): Set "1" at event channel 8 occurrence 6 Bit(64): Set "1" at event channel 7 occurrence 5 Bit(32): Set "1" at event channel 6 occurrence 4 Bit(16): Set "1" at event channel 5 occurrence 3 Bit(8): Set "1" at event channel 4 occurrence 2 Bit(4): Set "1" at event channel 3 occurrence 1 Bit(2): Set "1" at event channel 2 occurrence 0 Bit(1): Set "1" at event channel 1 occurrence	ABS	-
106 (6A)	206 (CE)	306 (132)	406 (196)	OUTSTS	Output status	R	0: output (OFF) 1: output (ON)	ABS	-

Register address (HEX)				Parameter	Description	Property (R/W)	Setting range	Unit	Initial value
CH1	CH2	CH3	CH4	n : Number of channel					
107 (6B)	207 (CF)	307 (133)	407 (197)	RJC	Reference junction compensation temperature value	R	EU (0 ~ 100%)	°C	-
108 (6C)	208 (D0)	308 (134)	408 (198)	TC	Thermo couple (TC) value	R	EU (0 ~ 100%)	°C	-
109 (6D)	209 (D1)	309 (135)	40 (199)	INP	Set input type	R/W	0~18: thermo couple (TC) 20~23: Resistance Temperature Detector (RTD) 30~ 32:direct current voltage (DCV) * Refer to input type	ABS	1 (TC K Type)
110 (6E)	210 (D2)	310 (136)	410 (19A)	CHMD	Set channel mode	R/W	0: Stop mode 1: Monitor mode 2: Run mode	ABS	0 (stop mode)
111 (6F)	211 (D3)	311 (137)	411 (19B)	AT	Run PID Auto Tuning(AT)	R/W	0: PID Auto Tuning (AT) stop 1: PID Auto Tuning (AT) start	ABS	0
112 (70)	212 (D4)	312 (138)	412 (19C)	OUT	Input type	R	0: RELAY 1: SSR 2: SCR	ABS	Follow product specs
113(71) ~ 120(78)	213(D5) ~ 220(78)	313(139) ~ 320(78)	413(19D) ~ 420(78)	EV.1DLY ~ EV.8DLY	Set event delay	R/W	0 ~ 9999	Sec.	0
121 (79)	221 (DD)	321 (141)	421 (1A5)	EV.1TY	Set event channel 1 type	R/W	None(OFF) 1:Deviation high limit 2: Deviation low limit 3: Deviation high/low limit 4: Within deviation scope 5: Deviation high limit (stand by) 6: Deviation low limit (stand by) 7: Deviation low/high limit (stand by) 8: Within deviation (stand by) 9:P.V high limit 10: P.V low limit 11: P.V high limit (stand by) 12:P.V low limit (stand by) 13: S.V high limit 14: S.V low limit 15: Loop break (LBA) 16: - 17: Run start (RUN) 18: Run/monitor mode (READY) 19: FAIL	ABS	0 (OFF)
122(7A)	222(DE)	322(142)	422(1A6)	EV.1VL	Event set value of event channel 1	R/W	EU S (0 ~ 100%)	°C	EU S (0%)
123(7B)	223(DF)	323(143)	423(1A7)	EV.1HY	Event channel 1, event hysteresis	R/W	EU S (0 ~ 10%)	°C	EU S (0,2%)
124(7C) ~ 144(90)	224(E0) ~ 244(F4)	324(144) ~ 344(158)	424(1A8) ~ 444(1BC)	EV.2~ ~ EV.8~	Set event channel 2~8 event type, set value and hysteresis	R/W	Same as event channel 1		
145 (91)	245 (F5)	345 (159)	445 (1BD)	LBA	Set loop break event time	R/W	0(OFF), 1~7200	Sec.	0 (OFF)
146 (92)	246 (F6)	346 (15A)	446 (1BE)	LBD	Set loop break event dead band	R/W	EU S (0 ~ 100%)	°C	EU S (100%)
147 (93)	247 (F7)	347 (15B)	447 (1BF)	EVSTOP	Set stop running at event occurrence	R/W	0: continuous run 1: stop run	ABS	0 (continuous run)
151 (97)	251 (FB)	351 (15F)	451(1C3)	PB	Set proportional band	R/W	EU S (0 ~ 100%)	°C	EU S (2%)
152(98)	252(FC)	352(160)	452(1C4)	TI	Set integral time	R/W	1 ~ 3600	Sec.	240
153(99)	253(FD)	353(161)	453(1C5)	TD	Set differentiation time	R/W	1 ~ 3600	Sec.	60
154(9A)	254(FE)	354(162)	454(1C6)	AP	Set 2DOF PID ALPHA	R/W	1 ~ 100	ABS	50
155(9B)	255(FF)	355(163)	455(1C7)	MR	Set Manual Reset	R/W	0.0 ~ 100.0	%	0.0

Register address (HEX)				Parameter	Description	Property (R/W)	Setting range	Unit	Initial value
CH1	CH2	CH3	CH4	n : Number of channel					
154(9A)	254(FE)	354(162)	454(1C6)	AP	Set 2DOF PID ALPHA	R/W	1 ~ 100	ABS	50
155(9B)	255(FF)	355(163)	455(1C7)	MR	Set Manual Reset	R/W	0.0 ~ 100.0	%	0.0
156(9C)	256(100)	356(164)	456(1C8)	CT	Set control cycle time	R/W	1 ~ 100	Sec.	RELAY : 30 Sec. SSR : 2 Sec.
157(9D)	257(101)	357(165)	457(1C9)	PO	Set emergency output	R/W	0.0 ~ 100.0	%	0
158(9E)	258(102)	358(166)	458(1CA)	HYS	Set hysteresis at ON/OFF control	R/W	EUS (0 ~ 10%)	℃	EUS (0.2%)
159(9F)	259(103)	359(167)	459(1CB)	RO	Set output at stop, monitor status	R/W	0.0 ~ 100.0	%	0
160(A0)	260(104)	360(168)	460(1CC)	RUP	Set SV increase temperature at RAMP control	R/W	EUS (0 ~ 100%)	℃	EUS (0%)
161(A1)	261(105)	361(169)	461(1CD)	RDN	Set SV decrease temperature at RAMP control	R/W	EUS (0 ~ 100%)	℃	EUS (0%)
162(A2)	262(106)	362(16A)	462(1CE)	RMIN	Set SV change time (min.) at RAMP control	R/W	0 ~ 1000	Minute	0
163(A3)	263(107)	363(16B)	463(1CF)	RHRS	Set SV change time (hr.) at RAMP control	R/W	0 ~ 100	Hour	0
164(A4)	264(108)	364(172)	464(1D0)	DR	Set control run	R/W	0: Reverse run (heating) control 1: Forward run (cooling) control	ABS	0 (Reverse run (heating) control)
165(A5)	265(109)	365(173)	465(1D1)	OHL	Set high limit to Manipulated Value	R/W	0.0 ~ 100.0	%	100.0
166(A6)	266(10A)	366(174)	466(1D2)	OLL	Set low limit to Manipulated Value	R/W	0.0 ~ 100.0	%	0.0
171(AB)	271(10F)	371(173)	471(1D7)	BS	Set input correction	R/W	EUS (-100 ~ 100%)	℃	EUS (0%)
172(AC)	272(110)	372(174)	472(1D8)	FL	Set input filter	R/W	0 ~ 100	ABS	0
173(AD)	273(111)	373(175)	473(1D9)	SVH	Set SV high limit	R/W	EU (0 ~ 100%)	℃	EU (100%)
174(AE)	274(112)	374(176)	474(1DA)	SVL	Set SV low limit	R/W	EU (0 ~ 100%)	℃	EU (0%)
175(AF)	275(113)	375(177)	475(1DB)	FRH	Set PV high limit	R/W	EU (0 ~ 100%)	℃	EU (100%)
176(B0)	276(114)	376(178)	476(1DC)	FRL	Set PV low limit	R/W	EU (0 ~ 100%)	℃	EU (0%)
177(B1)	277(115)	377(179)	477(1DD)	SLH	Set scale high limit at DCV input setting	R/W	EU (0 ~ 100%)	mV	EU (100%)
178(B2)	278(116)	378(17A)	478(1DE)	SLL	Set scale low limit at DCV input setting	R/W	EU (0 ~ 100%)	mV	EU (0%)
179(B3)	279(117)	379(17B)	479(1DF)	DOT	Set decimal point	R/W	0 ~ 3 : decimal point digit	ABS	0

3.3. Manipulation and run

3.3.1 Input section

● Input type (INP)

It is a parameter setting input signal (sensor) type, and once this input type is set, input scope (range) and decimal point indication or not is determined depending on the type of input. Input type can be set differently by channel. All parameters related to PV are initialized when changing input type.

※ Set Value (SV), Event Set value (EVVL), Event Hysteresis(EVHY), Event Loop break Dead Band (LBD), Set value High/Low Limit (SVH/SVL), Reading High/Low Limit (FRH/FRL), Scale High/Low Limit Setting (SLH/SLL), Set value Increase Temperature (RTUP), Set value decrease temperature(RTDN), input correction (BS), ON/OFF control hysteresis (HYS), decimal point(DOT), proportional band(PB), integral time (TI), Derivative time (TD) 2DOF ALPHA value (AP) Set Value(SV), event set value (EVVL), event hysteresis (EVHY), event loop break alarm dead band (LBD)

Symbol	INP	Input type	Input scope (°C)	Degree		
TC	1	K	(Note2) -200 ~ 1370	±0.3 % of F.S ±1digit		
	2	K			-199.9 ~ 1370.0	
	3	J			-200 ~ 1200	
	4	J			-199.9 ~ 1200.0	
	5	E			-199 ~ 999	
	6	E			-199.0 ~ 999.0	
	7	T			-50 ~ 400	
	8	T			-50.0 ~ 400.0	
	9	R	0 ~ 1700			
	10	B	(Note1) 0 ~ 1800			
	11	S	-		0 ~ 1700	
	12	L	(Note2) -199 ~ 900			
	13	L			-199.0 ~ 900.0	
	14	N	-		-199 ~ 1300	±0.6 % of F.S ±1digit
	15	U	(Note2) -50 ~ 400			
	16	U			-50.0 ~ 400.0	
	17	W	-		0 ~ 2300	
	18	PLII	-		0 ~ 1300	
RTD	20	KPt100	(Note3) -200 ~ 500	±0.3 % of F.S ±1digit		
	21	KPt100			-199.9 ~ 500.0	
	22	Pt100			-200 ~ 640	
	23	Pt100			-199.9 ~ 640.0	
DCV	30	0 - 10 V d.c.		0 ~ 10000		
	31	1 - 5 V d.c.		1000 ~ 5000		
	32	0 - 100 mV d.c.		0 ~ 1000		

F.S is from minimum value to maximum value of possible reading range of each input, and digit is minimum indication value.

(Note 1) 0~400°C range: ±10% of F.S±1digit

(Note 2) Below 0°C: ±1% of F.S±1digit

(Note 3) -150.0 ~ 150.0°C range: ±1% of F.S±1digit

※ When using 4 -20mA direct current input, please select input code 31, and attach 250 Ω of electric resistance to both input terminals.

● Input correction (BS)

Parameter to be set when temperature correction to Process Value (PV) is required
Reading can be expressed as addition of reading before input correction and set value of input correction.

● Input filter (FL)

Parameter to remove noise when it comes in to Process Value (PV) repetitively. Noise not only impairs control feature, but also causes surge in manipulated value. However, if input filter is set large, actual reading is expressed with time delay.



$$\text{Filtering PV} = \frac{\text{PV} - \text{PV}_1}{\text{FILT} / \text{Ts} + 1} + \text{PV}_1$$

- ※ PV : Process value
- PV_1 : Previous Process value
- FL : Input filter (FL) set value
- Ts : Sampling time (50 ms)

● Reference Junction Compensation (RJC)

When using temperature sensor as TC, as a principle, PV is expressed by correcting standard contact point correction. To verify TC and RJC individually, corresponding parameter can be used.

● Limit to Set Value (SV) by Set Value High (SVH) and Set Value Low (SVL)

SV is limited by SVH and SVL. Limited set value can be changed within the range of input type.

● Limit to Process value by Full Range High (FRH) and Full Range Low (FRL)

Set High and Low range of Process Value (PV). If it is out of the set range, OVER of alarm group 1 of CHESTS (channel status) is occurs. The control is operating normally.

● Input Scale Range High (SLH) / Scale Range Low (SLL) setting

It applies only if input type is set to voltage input (DCV).
The input range of PV is adjusted to the high limit or low limit of set scale.

● Parameter setting lock (LOCK)

This is a parameter that prohibits parameter setting.

LOCK set value	Details
0	All parameters setting possible
1	Possible to set only SV, R/S, AT, CHEN parameters
2	All parameters settings are impossible, but LOCK parameter is possible to set.

3.3.2 Control section

● Channel mode (CHMD)

Channel mode consists of 3 types including “stop mode”, “monitor mode”, and “run mode” and different setting for each channel is possible.

● Setting are completed at channel mode (CHMD) parameter, run status at each channel mode is as follows.

Channel mode	When run setting (R/S) is run start (RUN)	When run setting (R/S) is run stop
Stop mode	Control run (X), Even occurrence (X)	Control run (X), Even occurrence (X)
Monitor mode	Control run (X), Even occurrence (O)	Control run (X), Even occurrence (O)
Run mode	Control run (O), Even occurrence (O)	Control run (X), Even occurrence (O)

※ Run mode, if in run stop status, it functions similarly as the monitor mode. This status is called READY state.

● Run setting (R/S) and run setting state saving (R/S_S)

If “1(ON)” is set to run setting (R/S), it becomes “run start (RUN)” state, and all channels with channel mode set to “run mode” start control runs, and if “0(OFF)” is set to run setting (R/S), it becomes “run stop (STOP)” state, and all channels terminate control run. Also, as run setting save option can be set at R/S_S parameter, when power is first supplied, this run setting state can be maintained or set as “run stop (STOP)” state.

● Direction (DR)

This parameter is to set control run of each channel, and can be set at forward run or reverse run. When using as heating /cooling control by setting H/C parameter to “1”, control run (DR) setting is disregarded

Control run	Process Value (PV)	Manipulated Value (MV)
Reverse run (Heating control)	Increase	Decrease
	Decrease	Increase
Forward run (Cooling control)	Increase	Increase
	Decrease	Decrease

3.3.2 Standard, heating/cooling control (HC)

Control method can be set at Standard control or heating/cooling control. If heating/cooling control is set, control output is divided into 2 signals, one for heating and one for cooling. For control method, heating and cooling can be set as PID control or ON/OFF control respectively for output. If heating side proportional band (PB) is set to “0°C”, heating side is controlled as ON/OFF control output, and if cooling side proportional band (PBC) is set to “0°C”, cooling side is controlled as ON/OFF control output,

3.3.2 Dead band of heating/cooling control (HC_DB)

Upon heating/cooling control, dead band of heating side and cooling side manipulated value can be set up. For ON/OFF control, dead band of both heating side and cooling side is as follows.

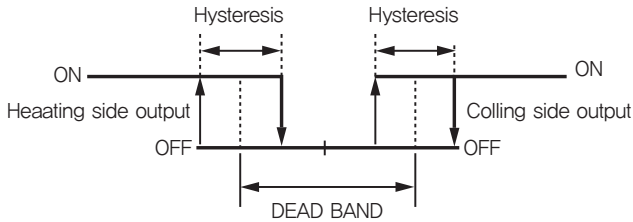

When heating side is PID and Cooling side is ON/OFF control

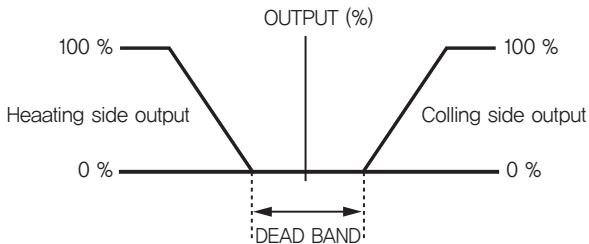
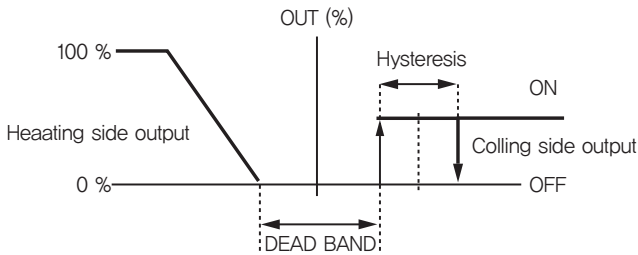

< When heating and cooling sides are PID control and dead band as much '+' set value. >

"-" set value dead band and the dead band for Heating & Cooling PID control are shown as below.

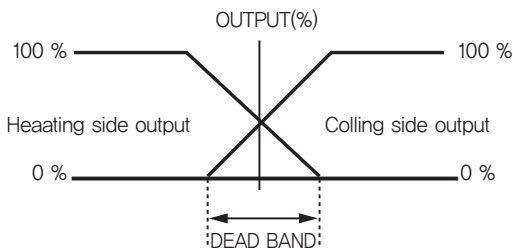

< Heating & Cooling are PID control and "-" set value dead band >

● Proportional Band (PB), Integral Time (TI), Derivative Time (TD)

Constant to control PID. These parameters are set up automatically if Auto Tuning (AT) is performed

● Auto Tuning (AT)

Normally, for 2DOF P.I.D control, Values of PID constants such as Proportional Band (PB), Integral Time (TI), Derivative Time (TD) should be set to targeted temperature value of equipment to be controlled, and proper values be applied. If Auto Tuning (AT) parameter is set to "1", PID constants is automatically set up after pre-set control run is performed, and after AT parameter is changed to "0", PID constant value applied control starts.

If Auto Tuning (AT) parameter is set to "1", corresponding channel mode is changed to run mode, run setting (R/S) is set to "1", and it becomes run start (RUN) state.

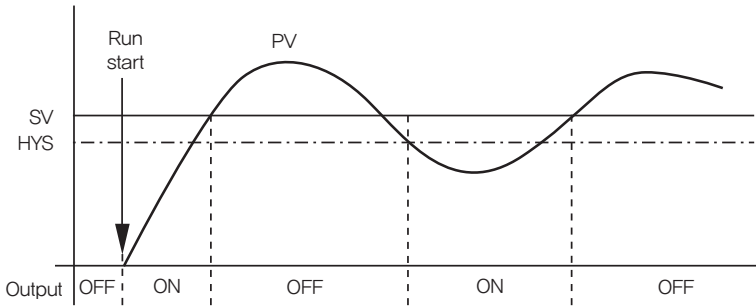

● ON/OFF control setting and Hysteresis (HYS)

If proportional band (PB) is set to "0", control method is changed from PID control to ON/OFF control. For ON/OFF control, Hysteresis value is applied and setting can be completed at HYS parameter.

● Output Cycle Time (CT)

A cycle that becomes ON and OFF of RELAY or voltage pulse (SSR) output is called “output cycle” and can be set at CT parameter. For RELAY output, if output cycle is set short, it can show quick responses, but lifespan is shortened. Thus, setting output cycle less than 20 seconds is not recommended.

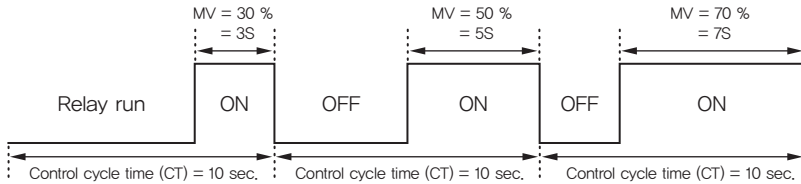

● 2DOF PID Alpha (AP)

Response in general closed loop control system can be mainly divided into response to set value change and response to disturbance, and existing PID (1DOF) algorithm is limited to optimize only one response for these two responses. 2DOF algorithm was applied to overcome this limitation, and response optimization to set value change and appropriate response to disturbance can be obtained. Alpha (AP) parameter is used for adjusting response feature to Set Value (SV).

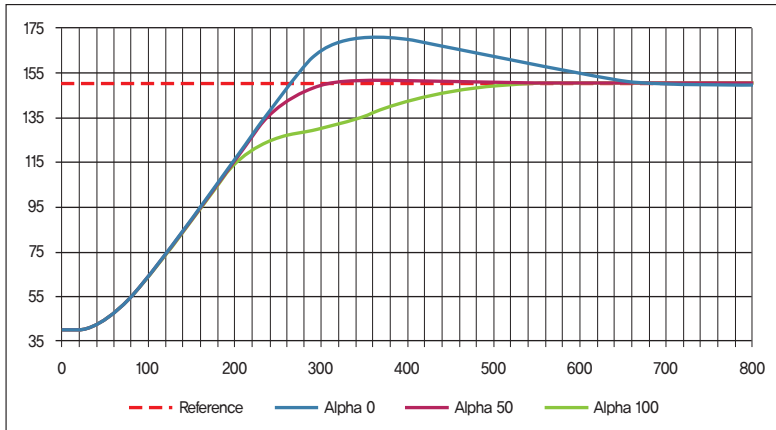

- **Manipulated Value (MV) high limit (OHL)/low limit (OLL)**

Controlled manipulated value can be limited by high limit value (OHL) and low limit value (OLL)

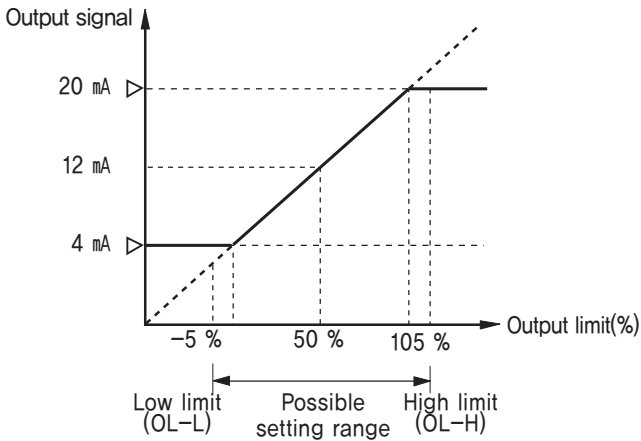

- **Manual Reset (MR)**

If Integral Time (TI) is set to "0" at PID control, it operates in PD control. For PD control, steady-state deviation occurs between Process Value (PV) and Set Value (SV). Changing manipulated value to reduce such deviation is called manual reset, and the setting can be completed at MR parameter.

- **Output capacity, PO at temperature sensor disconnection (BURN-OUT)**

For temperature sensor (BURN-OUT) disconnection, output capacity can be set and at PO parameter. Output capacity may vary depending on the type of warning. Please refer to "Run at warning occurrence."

- **Output capacity, RO at run stop/monitor (READY)**

If channel mode (CHMD) is monitor mode or run mode, and with run stopped, control output capacity can be set at RO parameter.

● Ramp function (RATE)

It refers to the indication that, Target Set Value (TSV) is reached at a preferred rate, set at RTUP (SV increase temperature) or RTDN (SV decrease temperature) based on time set at RTMIN (SV transit time in min.), RTHRS (SV transit time in hour).

Set value that changes based on time can be verified with current Target Set Value (TSV) parameter. Upon executing Auto Tuning (AT), ramp function stops, and auto tuning is performed using the last Set Value (SV).

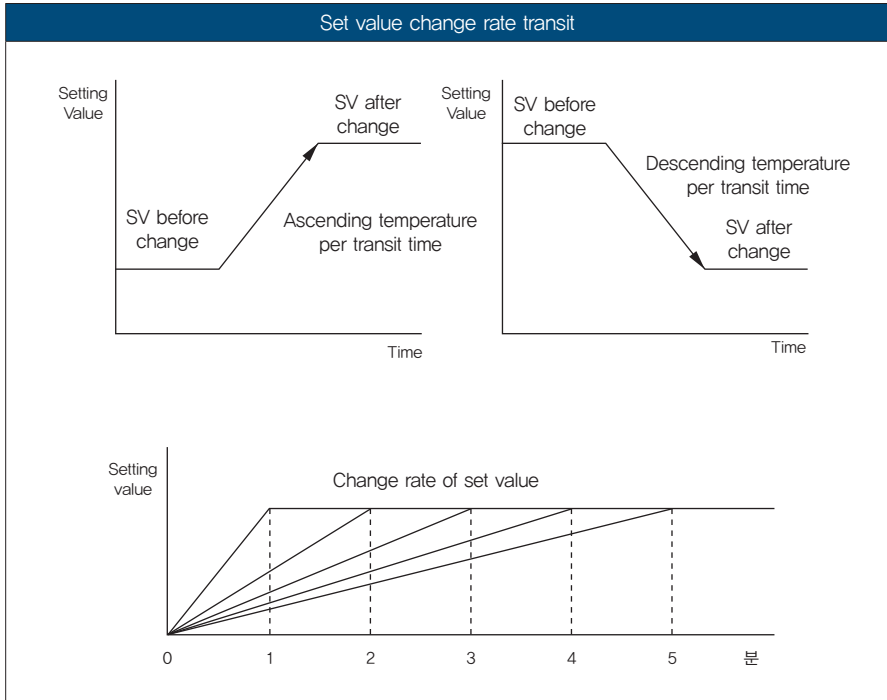

※ Run is not guaranteed if set value change rate per min. is set below 0.5 °C.
(below 3°C of set value change rate per hour)

3.3.3 Event section

● Event channel (EVCH) and event bus output (EVBUS)

Maximum of 8 channels by input channel are provided, and each can be set with different event type (EVT) and set value (EV). However event channel with event bus output is limited to 8 channels. Upon occurrence of set event, event (EV) LED of front section is turned on, event state (EV_STS) parameter is set to "1". Event occurrence can be verified at event channel state (EVSTS, [1~4]) parameter by input channel, and at input channel state (EV.[1~8]) parameter by event channel. If event occurs only with event channel that EVBUS.[1~8] parameter is set to "1", event bus is used for output.

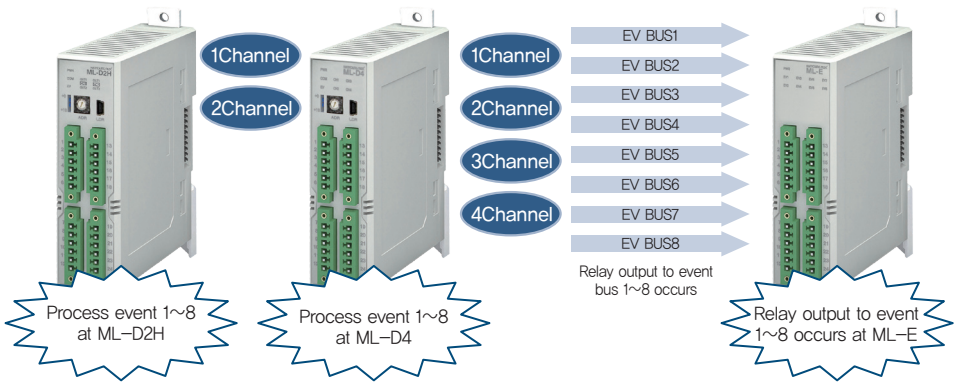

If one module is made up with several units combined, event bus output occurs with OR condition.

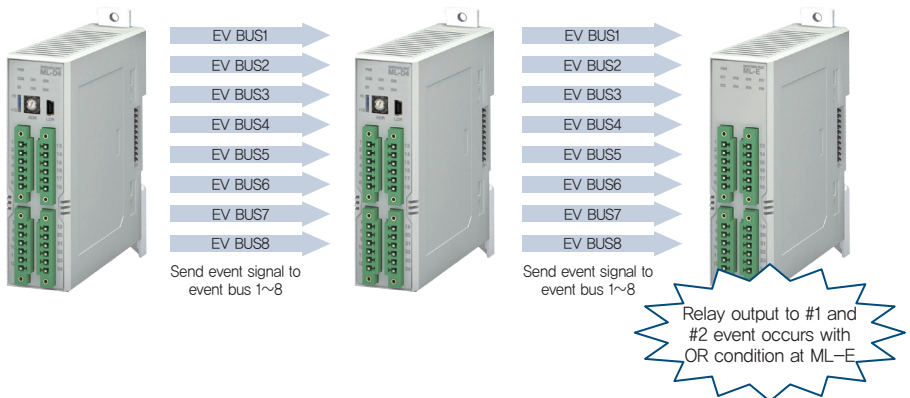

● Event type (EVTY)

Event type setting can be performed with event number at EVT parameter.

Event type	Event type	Stand by (have/not have)	Event type	Event type	Stand by (have/not have)
0	None	X	10	PV low limit	X
1	Deviation high limit	X	11	PV high limit	O
2	Deviation low limit	X	12	PV low limit	O
3	Deviation high/low limit	X	13	SV high limit	X
4	Within deviation range	X	14	SV low limit	X
5	Deviation high limit	O	15	Loop break alarm (LBA)	X
6	Deviation low limit	O	16	–	–
7	Deviation high/low limit	O	17	Run	X
8	Within deviation range	O	18	Stop/monitor (Ready)	X
9	PV high limit	X	19	Fail	X

※ O: have stand by, X: do not have stand by

*1: Only for ML-D2H

Run based on event type is as follows.

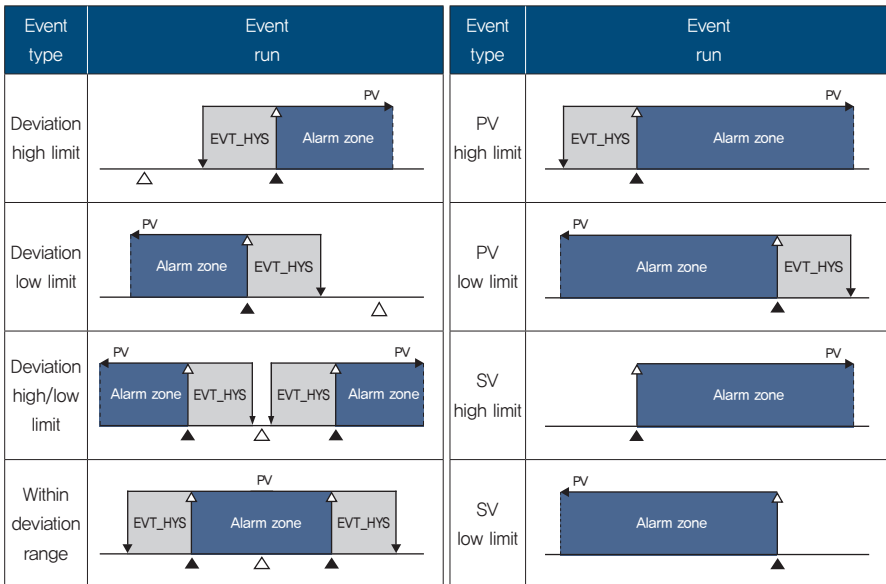

※ ▲ : Event set value (EV) △: SV

● Event set value (EVVL) and event hysteresis (EVHY)

Event set value is set at EVVL parameter, and event hysteresis at EVHY.
Setting range is different depending on event type.

Event type	Setting range	Initial value	Hysteresis
Deviation high limit	EUS (0 ~ 100 %)	EUS (100 %)	EUS (0 ~ 10 %)
Deviation low limit	EUS (0 ~ 100 %)	EUS (100 %)	EUS (0 ~ 10 %)
Deviation high/low limit	EUS (0 ~ 100 %)	EUS (100 %)	EUS (0 ~ 10 %)
Within deviation range	EUS (0 ~ 100 %)	EUS (0 %)	EUS (0 ~ 10 %)
PV high limit	EU (0 ~ 100 %)	EUS (100 %)	EUS (0 ~ 10 %)
PV low limit	EU (0 ~ 100 %)	EUS (0 %)	EUS (0 ~ 10 %)
SV high limit	EU (0 ~ 100 %)	EUS (100 %)	EUS (0 ~ 10 %)
SV low limit	EU (0 ~ 100 %)	EUS (0 %)	EUS (0 ~ 10 %)
Heater disconnection (HBA)	0 / 1 ~ 50 A	0 (OFF)	2 A

* Setting range and hysteresis are not applied to events other than the above types.

* If event type (EVTY) is changed, event set value (EVVL) and event hysteresis (EVHY) are initialized.

If process value (PV) is out of pre-set event value (EVVL), event occurs, and for release, it should approach up to event hysteresis (EVHY). For process value (PV) high event, event occurrence and release are as below.

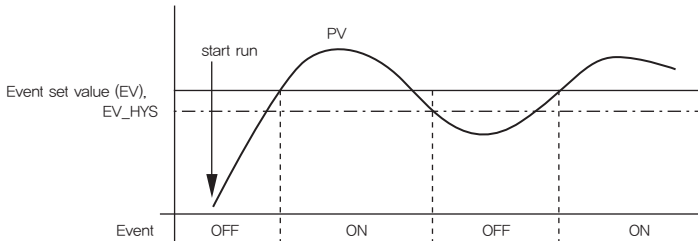

● Event stand by run

If correspond to below conditions, in event stand by run, very first event does not take place at event occurrence.

- When power is supplied
- When run is started
- When event type (EVT) is changed
- When Set Value (SV) is changed

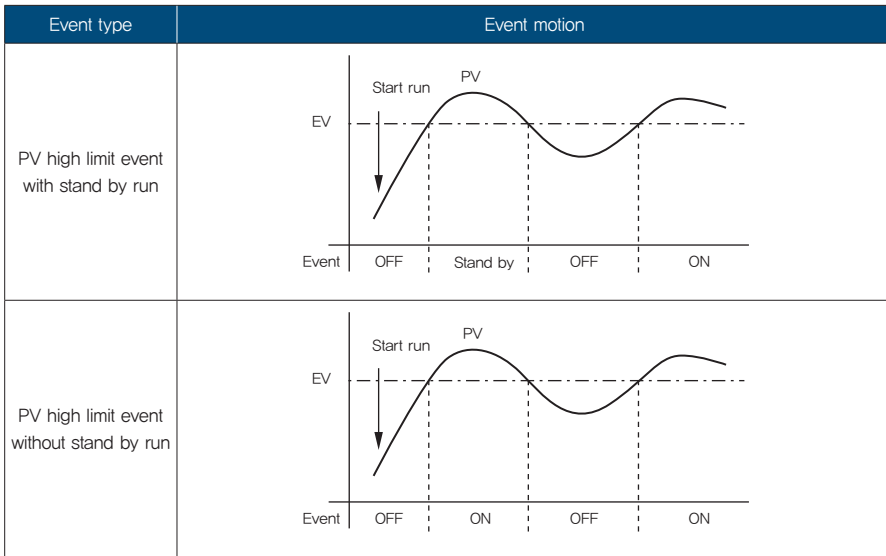

● Loop break event

With loop break alarm function, state such as heater break and incorrect wiring, break and short circuit of temperature sensor, and output circuit irregularity can be detected. Loop break event time (LBT) is set automatically when running auto tuning by setting "15" at event type (EVTY), and with loop break alarm time (LBT) set to double of total integral time (TI). If conditions are as below during loop break alarm time (LBT), loop break alarm (LBA) occurs.

Control run (DR)	Manipulated Value (MV)	Loop break alarm (LBA) occurrence condition
Reverse run (heating control)	100 %	No ascending of over 2°C (if direct current voltage DCV, 2%)
	0 %	No descending of over 2°C (if direct current voltage DCV, 2%)
Forward run (cooling control)	100 %	No descending of over 2°C (if direct current voltage DCV, 2%)
	0 %	No ascending of over 2°C (if direct current voltage DCV, 2%)

* Loop break alarm occurs only if Manipulated Value (MV) is 100% or 0%.

※ If Process Value (PV) is within the range of proportional band (PB), and if loop break dead band (LBD) parameter is set and Process Value (PV) is within the range of dead band, event does not occur even with Loop Break Alarm (LBA) occurring condition, and occurs only if out of Proportional Band (PB).

- $LBD > PB$

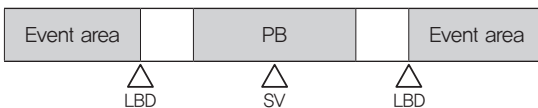

- $LBD \leq PB$

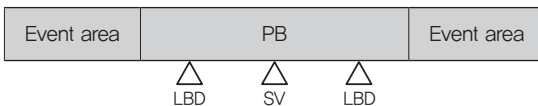

● Run, stop/monitor (Ready), FAIL event

For run state event, event (EV) LED is not turned on even when corresponding event occurs, and with no impact at parameters of event state (EV_STS), event channel state (EVSTS,[1~4]) by input channel, and event channel state (EVSTS,[1~8]STS) by input channel, and has effect only when used by connecting with event unit (ML-E8). It can be used by setting run state event, and with corresponding event bus output parameter set to "1".

Run state event	Occurrence condition
Run state event	If channel mode (CHMD) is "run mode" and run setting (R/S) is "run start", event occurs.
Stop/monitor (READY) state event	If channel mode (CHMD) is "monitor mode" or "run mode", and run setting (R/S) is "run stop", event occurs.
FAIL state indication event	Event occurs at normal state. If abnormality occurs to power source, ROM, and RAM state, event occurrence stops.

Among run state indication events, FAIL event operates regardless of channel modes.

● Control stop (EVSTOP) at event occurrence

If event specified in each input channel occurs, control run can be set to sustain or stop. When setting EVSTOP parameter to "1", if event occurs, control run stops and if event is released, control run restarts.

● Control stop setting(COMCHK) at RS485 communication disconnection

In case of no response for transmission for pre-set time by setting communication connection sustaining time with RS485 Master, control can be stopped, and it can be set at COMCHK parameter.

3.3.4 State indication and setting

● Front side LED indication

Power (PWR) LED	Upon completion of initialization for run after power is supplied, LED light is turned on. Initialization time is about 3 seconds.
Communication (COM) LED	During RS485 communication, if data of address set with front section setting switch is received, LED blinks. If data other than pre-set address is received, COM LED remains turned off.
Event (EV) LED	If at least one of pre-set event occurs, EV indication LED is turned on. As event no. 17~19 of run, stop/monitor (READY), FAIL event are for informing run state, LED will not turn on at event occurrence.
ML-D2H	control output (CH1~2) LED Manipulated value controlled based on channel is indicated in 4 seconds cycle and 8 steps by blinking LED light. If manipulated value is 50%, it turns on for 2 seconds, and turns off for 2 seconds, and for 25%, it turns on for 1 second, and turns off for 3 seconds When Auto Tuning (AT) is in progress: Repeatedly blinking every 0.2 seconds
ML-D4	

● LED display at warning occurrence

LED state display	Warning occurrence state
When "[Warning group2] alert occurs, all LEDs repeat 0.5 second cycle blinking	1. System Data error 2. Calibration Data error 3. Input circuit error 4. EEPROM error
When "[Warning group1] alert occurs, power (PWR) LED repeats 0.5 second cycle blinking	1. Auto tuning is not terminated within 24 hours 2. Standard contact point correction (RJC) error 3. Within $\pm 5\%$ of input range, OVER 4. Input sensor error (BURN-OUT)
Power (PWER), communication (COM), event (EV) LED repeat 0.5 second cycle blinking	If communication is disconnected by exceeding RS485 communication sustaining time

※ For warning group, refer to input channel state display (CHSTS)

● Input channel state display (CHSTS)

Input channel state displays in BIT MAP at CHSTS parameter.

It is comprised of 16 bit, high 9~16 bit indicates "warning state", and 1~3 bit "run state", and bit is set to "1" when reaching corresponding state. OR run is performed if several warnings occur.

CHSTS	Name	Description	Warning group
Bit 16	SYD	System Data error [32768]	[Warning group 2]
Bit 15	CALIB	Calibration Data error [16384]	
Bit 14	ADC	Input circuit error [8192]	
Bit 13	EEPROM	EEPROM error [4096]	
Bit 12	ATE	Auto tuning does not terminate within 24 hours[2048]	[Warning group 1]
Bit 11	RJC	Standard contact point correction (RJC) error [1024]	
Bit 10	OVER	Within $\pm 5\%$ of input range, OVER [512]	
Bit 9	B,OUT	Input sensor error (BURN-OUT) [256]	
Bit 4~8	—	Not used	—
Bit 3	AT	Indicate auto tuning is operating [4]	—
Bit 2	MONIT	Control run does not work, display event occurring input channel state [2]	—
Bit 1	Run	Display control run and event occurring input channel state [1]	—

※ If Run state and B,OUT warning occurrence, CHSTS parameter is set to "257."

● Event channel state indication

At event occurrence, front section event (EV) LED is turned on and it can be verified with parameters below.

Parameter	Description
Event status (EV_STS)	If at least one event of pre-set event channels occurs, "1" is set.
Event channel state by input channel (EVSTS.[1~4])	Event channel state can be confirmed by input channel. Used when verifying which number event channel caused event in corresponding input channel Composed of 16 bit, and processed by OR run. Bit 1: input channel, Bit 2: input channel 2, Bit 3: input channel, Bit 4: input channel 4
Event channel state by input channel (EV.[1~8]STS)	Input channel state can be verified by event channel. Used when verifying which input channel occurred event in corresponding event channel Composed of 16 bit, and processed by OR run. Bit 1: event channel 1, Bit 2: event channel 2, Bit 3: event channel 3, Bit 4: event channel 4, Bit 5: event channel 5, Bit 6: event channel 6, Bit 7: event channel 7, Bit 8: event channel 8

● Control and event bus output state indication

If output occurs by parameter indicating state of occurrence of output using control and event bus, "1" is set.

Parameter	Description
Control output state (OUTSTS)	Indicate control output state of channel
Event bus output state (DOSTS)	Indicate event bus output state Event output can occur only if event occurs in event channel corresponding channel at event bus output (EVBUS) parameter is set to "1", and output state can be changed.

● Other state display

Parameter	Description
Control output type (OUT)	Indicate control output type
Switch address (ADDR)	Indicate set value of front section setting switch
Number of channel (MAX_CH)	Indicate number of input channel
System data (R_SYS)	Set value in order to distinguish product
Option data (R_OPT)	Set value in order to distinguish product
Version (ROMVER)	Indicate firm ware version

● Execute parameter state initialization (PARA_INT)

Initialize pre-set parameter and restore to factory shipments condition
After parameter initialization, turn off power and turn back on power

● Set whether to save parameter used in communication (PARA_SAVE)

This function is to set whether to save parameter that used in communication, and sets by PARA_SAVE parameter. If PARA_SAVE is set to "0", parameter is saved, and if it is set to "1", parameter value approached by communication is not saved.

● Execute all parameter save (PARA_COPY)

When parameter is not saved by RS485 communication, with this function, all parameters can be saved by setting PARA_SAVE to "1". When parameters such as Set Value (SV) change frequently, this is used to increase memory lifespan by saving parameter at desired time after setting PARA_SAVE to "1", in order to prevent shortening lifespan of memory, where parameters are saved

3.3.5 Warning occurrence and handling

Depending on warning occurrence type, Process Value(PV) and Manipulated Value (MV) are processed as follows.

Type	Cause	Process Value (PV) display	Manipulated Value (MV) state
B,OUT	Input sensor error	Reverse run: 105%, forward run: -5%	PO output after closing control
OVER	PV is out of input range within $\pm 5\%$	Normal process	Normal process
RJC	RJC error	Reference junction compensation temperature is normalized to the deleted temperature value.	Reference junction compensation temperature is normalized to the deleted temperature value.
ATE	Auto tuning error	Normal process	Normal process
EEPROM	EEPROM error	Reverse control: 105%, control: -5%	0%
ADC	Input circuit error	Reverse control: 105%, control: -5%	0%
CALIB	Calibration error	Reverse control: 105%, control: -5%	0%
SYSD	System Data error	Reverse control: 105%, control: -5%	0%

4. Specification

► Performance

Degree of indication	$\pm 0.3\%$ of FS ± 1 Digit
Insulation resistance	Over 500 V d.c. 20 M Ω (between power section and input terminal)
Withstanding voltage	750 V a.c. 1 min. (power section and input terminal)

► Input

Thermo couple	K, J, E, T, R, B, S, L, N, U, W, PL2	Individual section by channel through INP setting parameter
Thermo-resistor	Pt100 Ω , KPt100 Ω	
Direct current voltage	0 – 100 mV, 1 – 5 V, 0 – 10 V	
Sampling cycle	50 ms.	
Input indication resolving power	Below minimum unit of input range	
Input impedance	Thermo couple and direct current voltage input: over 1M Ω	
Impact of allowed input resistance	About 0.2 μ V / Ω	
Allowed input conducting wire resistance	Thermo-resistor (below 10 Ω . however, resistance among 3 lines should be same)	
Allowed input voltage	Within –2 – 5 (Thermo couple, thermo-resistor), within –5 – 12 V (direct current)	
Input correction	$\pm 100\%$ of input range	
Cold junction compensation error	± 1.5 $^{\circ}$ C (0 ~ 50 $^{\circ}$ C)	
Input signal break detection	up scale	

► Output

Control output (ML-D)	RELAY	1a contract point
		250 V a.c., 3 A, 30 V d.c. 3 A
	SSR	Over 12 V (over 600 Ω of load resistance) if short circuit, limit to about 25 mA
		Time resolving power: larger side between control cycle 0.1% or 10 m
	SCR	4 –20 mA d.c. (below load resistance 600 Ω)
		Degree: $\pm 0.1\%$ of FS (4–20 mA scope)

► Control function

Control method	ML-D2H	PID (heating/cooling simultaneous control) / 2DOF PID (single control) / ON-OFF control
	ML-D4	2DOF PID (Auto tuning support) / ON-OFF control
Control run		Random selection of reverse run (heating) / forward run (cooling) (DR parameter setting)
Proportional band		0 ~ 100 % of FS
Integral time		0 ~ 3,600 sec.
Derivative time		0 ~ 3,600 sec.
Control cycle time		About 25 ~ 30 seconds (relay control output), 2 ~ 4 seconds (voltage pulse (SSR) control output)
ON/OFF control		Set proportional band to "0"
Manual reset		Possible to use manual RESET setting when integral time is 0 second
Alarm setting range		0~100% of input range (absolute alarm), ±100% of input range (deviation alarm)
Alarm hysteresis		By EVHY parameter setting
Alarm type		By EVTY parameter setting (19 types)
Heater disconnection alarm	ML-D2H	Possible to use in ON/OFF control, time proportional control output (impossible to detect if output ON/OFF time is less than 0.2 second) Measuring current: 1-5 A a.c. (resolving power: 0.5 A ± 5% of FS ±1 Digit) Heater disconnection detection use (CT type) model name: CT-50N

► RS232C Communication

Communication method	RS-232 EIA standard
Maximum communication distance	15 m
Transmission speed	9600 bps
Start bit	1 bit
Data length	8 bit
Parity bit	Even
Stop bit	1 bit
Support protocol	PC-Link

▶ RS485 communication

Communication method	RS-485 EIA standard / 2 line type semi-double
Maximum number of access	31 units
Maximum communication distance	1200 m
Communication sequence	No sequence
Communication speed	9600, 19200, 38400, 76800 bps [initial value: 9600]
Start bit	1 bit
Data length	7, 8 bit [initial value: 8]
Parity bit	None, Odd, Even [initial value: Even]
Stop bit	1, 2 bit [initial value: 1]
Response time	Reception handling time + (response time x 10 ms)
Support protocol	PC-Link, PC-Link with SUM, Modbus ASCII/RTU [initial value: PC-Link]

▶ Power source specification

Power source voltage	24 V d.c.	
Voltage regulation	±10% of power source voltage	
Power consumption	Maximum 7W below	ML-D4S/C, ML-D2HMS/SS
	Maximum 5W below	ML-D4M, ML-D2HMM
	Maximum 3W below	ML-E

▶ General specification

Usage surroundings temperature	0 ~ 50 °C
Usage surroundings humidity	35 ~ 85% RH (however, there should not be condensation)
Run environment	Should not be areas with toxic gas, magnetic field or dust
Warming up time	Minimum 30 minutes
Influence by surrounding temperature	Thermo couple, direct current voltage: Larger side between $\pm 3 \mu\text{V} / ^\circ\text{C}$ or $\pm 0.03\%$ of FS / °C Thermo-resistor: Below $\pm 0.1^\circ\text{C} / ^\circ\text{C}$
Influence by power supply change	Larger side between $\pm 3 \mu\text{V} / 10 \text{ V}$ or $\pm 0.03\%$ of FS / 10 V
Storage temperature	-25 ~ 65 °C
Storage humidity	5 ~ 95% RH (however, there should not be condensation)
Shock	Less than 1 m in packaged condition
Weight	About 220g (excluding box)

► Display

Display score	7 contacts
Display detail	LED display based on status Power source (PWR): red turns on Event state (EV): red turns on RS485 communication state (COM): green turns on Control state by channel (CH1 ~ CH4): red turns on

► Event output (ML-E)

Event output (ML-E) 8 points	RELAY	Contact point method: 1a contact point	
		250 V a.c. 3 A, 30 V d.c. 3 A	
	Event type	ML-D2H	ML-D4
		<ul style="list-style-type: none"> 0 : None(OFF) 1 : Deviation high limit 2 : Deviation low limit 3 : Deviation high/low limit 4 : Within deviation scope 5 : Deviation high limit (stand by) 6 : Deviation low limit (stand by) 7 : Deviation low/high limit (stand by) 8 : Within deviation (stand by) 9 : PV high limit 10 : PV low limit 11 : PV high limit (stand by) 12 : PV low limit (stand by) 13 : SV high limit 14 : SV low limit 15 : Loop break alarm (LBA) 16 : Heater break alarm (HBA) 17 : Run start (RUN) 18 : Run/monitor mode (READY) 19 : FAIL 	<ul style="list-style-type: none"> 0 : None(OFF) 1 : Deviation high limit 2 : Deviation low limit 3 : Deviation high/low limit 4 : Within deviation scope 5 : Deviation high limit (stand by) 6 : Deviation low limit (stand by) 7 : Deviation low/high limit (stand by) 8 : Within deviation (stand by) 9 : PV high limit 10 : PV low limit 11 : PV high limit (stand by) 12 : PV low limit (stand by) 13 : SV high limit 14 : SV low limit 15 : Loop break alarm (LBA) 16 : - 17 : Run start (RUN) 18 : Run/monitor mode (READY) 19 : FAIL

ML series



HANYOUNG NUX CO.,LTD.

28, Gilpa-ro 71 beon-gil, Nam-gu, Incheon, Korea

Tel : +82-32-876-4697 Fax : +82-32-876-4696 E-mail : overseas@hynux.com