



## CG-WIFI CLICKNGO MODULE WI-FI INTERFACE

DATASHEET – V1.1x

---



1. This datasheet is recommended for ClickNGo CG-WiFi modules running firmware version V1.1x or later.
2. This module is compatible with N20K48 units running firmware version V1.03 or later.

1.	INTRODUCTION.....	3
2.	DIMENSIONS .....	3
3.	HOW TO INSERT THE MODULE TO THE DEVICE.....	4
4.	MODULE OPERATION.....	5
5.	LED INDICATORS .....	6
6.	MODBUS-TCP PROTOCOL.....	7
	6.1 MODBUS COMMANDS.....	7
	6.2 SPECIAL COMMANDS .....	7
	6.3 REGISTERS TABLE.....	7
	6.4 STATUS WORDS.....	8
7.	MQTT PROTOCOL.....	9
	7.1 PUBLISH TOPICS .....	9
	7.1.1 FAST PUBLISHING TOPICS .....	9
	7.1.2 SLOW PUBLISHING TOPICS .....	9
	7.1 RECEIVING COMMANDS VIA MQTT .....	9
	7.2.1 SUBSCRIBER TOPIC .....	9
8.	COMMUNICATING WITH NOVUS CLOUD .....	10
	8.1 LINKING YOUR EQUIPMENT TO NOVUS CLOUD.....	10
	8.2 REGISTERING VARIABLES IN NOVUS CLOUD.....	11
9.	CONFIGURATION SOFTWARE AND APP.....	13
	9.1 WI-FI AND MODBUS-TCP COMMUNICATION.....	13
	9.2 MQTT PROTOCOL .....	14
	9.2.1 MQTT BROKER.....	14
	9.2.2 NOVUS CLOUD.....	15
	9.3 MQTT CHANNELS .....	15
	9.4 ACCESS POINT CONFIGURATION.....	16
10.	FIRMWARE UPDATE.....	18
	10.1 FIRMWARE UPDATE PROCESS.....	18
	10.2 FIRMWARE UPDATE FOR GENERIC-BROKER USERS – V1.02 TO V1.10.....	19
	10.2.1 OVERVIEW.....	19
	10.2.2 UPDATE STEPS.....	19
	10.2.3 MANUAL MQTT-TOPIC CONFIGURATION (GENERIC BROKER ONLY).....	19
11.	MAINTENANCE.....	21
12.	TECHNICAL SPECIFICATIONS.....	22
	12.1 CERTIFICATIONS.....	22
13.	WARRANTY.....	23

## 1. INTRODUCTION

The **CG-WiFi** ClickNGo module turns the **N20K48** into an IoT device that can perform signal acquisition through the cloud. It was designed to work as an expansion module for **NOVUS'** line of modular controllers.

**CG-WiFi** must be attached to the controller dock (to insert the module to the controller, make sure the device is turned off). Once inserted, it will be automatically recognized. Its configuration parameters will be displayed according to the slot in which the module has been attached to the dock.

You can configure this module directly at the controller, through the **QuickTune** software, or through the **QuickTune Mobile** app.

## 2. DIMENSIONS

Built in UL94 polycarbonate and with an IP20 protection rating, the **CG-WiFi** ClickNGo module has an identification engraving on the top and the following dimensions:

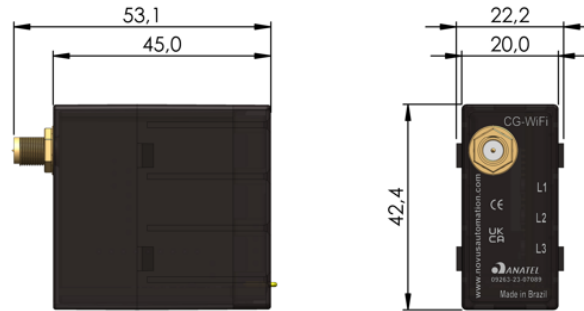

Figure 1

You must use an antenna with **CG-WiFi**:

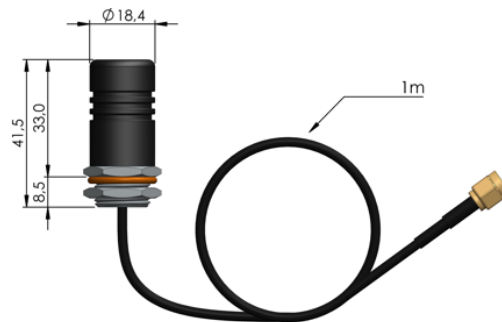

Figure 2

The **CG-WiFi** ClickNGo module is compatible with 2.4 Ghz RP-SMA Wi-Fi antennas.

### 3. HOW TO INSERT THE MODULE TO THE DEVICE



**Before you insert or remove a ClickNGo module from the device, make sure the device has been turned off.**

Once the dock has been attached to the controller, simply plug the **CG-WiFi** ClickNGo module into the desired slot, pressing it in until it clicks into place. If the module does not click into place, it is either not properly attached, or it has been plugged into the wrong slot.

The **CG-WiFi** ClickNGo module uses four adjacent slots in the dock. Thus, you must insert it in the 1-4 or 5-8 positions.

Once the **CG-WiFi** ClickNGo module is inserted into the dock and the device has been turned on, it will be automatically recognized. You can use the navigation keys to go through the parameter cycles and access the settings of the added module (see OPERATION section of the equipment manual).

Directly at the controller, it is possible to perform a minimal configuration on the ClickNGo **CG-WiFi** module. The parameters for this minimum specification are automatically made available and organized in a specific cycle, depending on the position of the module in the controller cabinet. A **CG-WiFi** ClickNGo module inserted into slot 1-4 of the dock, for example, can be viewed within the Configuration Cycle, under module 1 (**CFG >> Md. 1**).

Once a module is removed from the dock, it will no longer be recognized by the device and any settings made will be lost.

## 4. MODULE OPERATION

Once the module has been attached to the device, the controller will display the following parameters:

<b>Enbl</b> <i>Enabled</i>	Allows you to set the status of the <b>CG-WiFi</b> ClickNGo module: <b>YES</b> Module enabled. <b>no</b> Module disabled.
<b>R.P.En</b> <i>Access Point Enabled</i>	Allows you to configure the <b>CG-WiFi</b> ClickNGo module via Access Point mode (see <a href="#">ACCESS POINT CONFIGURATION</a> section): <b>YES</b> AP mode enabled. <b>no</b> AP mode disabled.

Table 1

The parameters will be displayed in the cycle related to the position of the module in the device dock.

	<p><b>If the module is removed from the controller dock, all settings will be lost. Therefore, when possible, use QuickTune software or the QuickTune Mobile application to save a version of the settings you have made.</b></p>
---	---

For more information on the controller's primary operation, see the OPERATION chapter of the equipment manual.

## 5. LED INDICATORS

CG-WiFi has 3 LEDs, located on the front of the equipment. The operation and description of each LED is shown below:

NAME	COLOR	STATUS	DESCRIPTION
L1	Green	On	CG-WiFi is enabled and perfectly configured.
		Flashing	CG-WiFi is enabled, but there is a problem in the configuration process (For example: Invalid SSID or password).
		Off	CG-WiFi is disabled.
L2	Red	On	A service is showing an error.
		Flashing	A service is showing a configuration error (For example: Invalid Broker URL or Broker not configured).
		Off	The services (TCP, MQTT, etc.) are not showing any errors.
L3	Green	On	CG-WiFi is connected to the Wi-Fi network.
		Flashing	Data is being transmitted.
		Off	CG-WiFi is not connected to the Wi-Fi network.

Table 2

## 6. MODBUS-TCP PROTOCOL

**CG-WiFi** is compatible with the Modbus-TCP protocol, a data communication protocol to connect the equipment to supervisory control and data acquisition systems (SCADA).

In addition to helping monitor **N20K48**, you can configure the **CG-WiFi** parameters (see [REGISTERS TABLE](#) section). By default, the Modbus-TCP port is set to the value 502. To change it, you need to use **QuickTune** software or **QuickTune Mobile** app (see [CONFIGURATION SOFTWARE AND APP](#) chapter).

### 6.1 MODBUS COMMANDS

Using the register table, it is possible to access (read and/or write) the configurable parameters of the controller. The available Modbus commands are as follows:

03	Read Holding Register
05	Force Single Coil
06	Preset Single Register
16	Preset Multiple Register

The registers are described in the [REGISTERS TABLE](#) section. All registers are 16-bit integers.

### 6.2 SPECIAL COMMANDS

It is important to note that the **Slave ID** parameter of the Modbus-TCP protocol must be filled with specific values to read the **N20K48** parameters or the **CG-WiFi** parameters.

- **Slave ID to read Host (N20K48): 255**
- **Slave ID to read the module (CG-WiFi): 254**

### 6.3 REGISTERS TABLE

The **CG-WiFi** ClickNGo module has the following registers:

ADDRESS	REGISTER	DESCRIPTION	TYPE
0	MODULE_SN_HI	First 4 digits of the serial number. Hexadecimal format.	RO
1	MODULE_SN_LO	Last 4 digits of the serial number. Hexadecimal format.	RO
2	MODULE_ID	Identification number.	RO
3	MODULE_FW_VERSION	Firmware version.	RO
		Reserved.	
5	MODULE_WIFI_ENABLE	Enable the <b>CG-WiFi</b> ClickNGo module.	RO
6	MODULE_DHCP_ENABLE	Enable DHCP.	RO
7	MODULE_IP_ADDR_0_1	IP address.	RO
8	MODULE_IP_ADDR_2_3		RO
9	MODULE_IP_MASK_0_1	Subnet mask.	RO
10	MODULE_IP_MASK_2_3		RO
11	MODULE_IP_GATEWAY_0_1	Default Gateway address.	RO
12	MODULE_IP_GATEWAY_2_3		RO
13	MODULE_IP_DNS_0_1	DNS server address.	RO
14	MODULE_IP_DNS_2_3		RO
15	MODULE_MODBUS_TCP_ENABLED	Enable TCP-Client function.	RO
16	MODULE_MODBUS_TCP_PORT	Modbus-TCP port.	RO
17	MODULE_WIFI_MODE_SEL	Enable AP mode.	RO
		Reserved.	
100	HR_INFO_HOST_SN_HI	First 4 digits of the Host serial number.	RO
101	HR_INFO_HOST_SN_LO	Last 4 digits of the Host serial number.	RO
102	HR_INFO_FIRMWARE_SUBVERSION	<b>CG-WiFi</b> ClickNGo module firmware version.	RO
103	HR_INFO_IP_ADDR_0_1	IP address.	RO
104	HR_INFO_IP_ADDR_2_3		RO

ADDRESS	REGISTER	DESCRIPTION	TYPE
105	HR_INFO_WIFI_MAC_ADDR_0_1	MAC address.	RW
106	HR_INFO_WIFI_MAC_ADDR_2_3		RO
107	HR_INFO_WIFI_MAC_ADDR_4_5		RO
108	HR_INFO_WIFI_LQI_RX	Received Signal Strength Indicator Level (RSSI).	RO
109	HR_INFO_WIFI_STATUS01	See tables in the <a href="#">STATUS WORDS</a> section.	RO
110	HR_INFO_WIFI_STATUS02		RO

Table 3

## 6.4 STATUS WORDS

The **CG-WiFi** ClickNGo module has the following status words:

REGISTER	VALUE FORMAT	
	BIT	DESCRIPTION
Status Word 01 – General	0	Module status: 0 → Disabled   1 → Enabled.
	1	Wi-Fi network connection: 0 → Not connected   1 → Connected.
	2	MQTT service status: 0 → Disabled   1 → Enabled.
	3	MQTT service connection: 0 → Not connected to Broker   1 → Connected to Broker.
	4	Modbus-TCP service status: 0 → Disabled   1 → Enabled.
	5	Modbus-TCP service: 0 → Not connected   1 → Connected.
	6	Access Point mode: 0 → Disabled   1 → Enabled.
	7~15	Reserved.
REGISTER	VALUE FORMAT	
	BIT	DESCRIPTION
Status Word 02 – Services	0	SSID/Wi-Fi Password: 0 → Valid   1 → Invalid.
	1	Manual IP address: 0 → Valid   1 → Invalid.
	2	AP mode status: 0 → No error   1 → Error.
	3	TCP socket creation: 0 → No error   1 → Error.
	4	TCP socket initialization: 0 → No error   1 → Error.
	5	Reserved.
	6	MQTT Service Initialization: 0 → No error   1 → Error.
	7	MQTT service URL: 0 → No error   1 → Error.
	8	MQTT service configuration: 0 → No error   1 → Error.
	9~15	Reserved.

Table 4

## 7. MQTT PROTOCOL

The **CG-WiFi** ClickNGo module supports the Message Queue Telemetry Transport (MQTT) protocol, a protocol designed for low data bandwidth consumption that uses the Publish/Subscribe paradigm to exchange messages.

Acting as an MQTT Publisher/Subscriber, **CG-WiFi** needs an intermediary called a Broker, responsible for sending messages from Publishers to Subscribers.

**CG-WiFi** is a Publisher/Subscriber that provide information about any Host register or **CG-WiFi** internal register. It has 2 publishing topics and 1 subscribing topic. You can use the register function to configure these registers. This function is available in **QuickTune** software and **QuickTune Mobile** app (see [MQTT CHANNELS](#) sections).

If configured, this protocol also allows **CG-WiFi** to communicate with Amazon Web Services (AWS). To do this, check the **AWS via MQTT: Configuration Manual**, available on our website.



The MQTT protocol and NOVUS Cloud feature do not work simultaneously.

### 7.1 PUBLISH TOPICS

When connecting to a Broker, **CG-WiFi** allows you to register up to 2 editable topics, which will be presented below.

#### 7.1.1 FAST PUBLISHING TOPICS

- **NOVUS/<sn><sup>1</sup>/channels/fast**: Topic for publishing registers that need a fast-publishing speed. Value in seconds (0 to 9999 s). You can change this topic.

**Example:**

```
{["variable":"PV","value":"25.100"],{"variable":"SP","value":"41.600"}}
```

#### 7.1.2 SLOW PUBLISHING TOPICS

- **NOVUS/<sn><sup>2</sup>/channels/slow**: Topic for publishing registers that need a slower publishing speed. Value in minutes (0 to 9999 min). You can change this topic.

**Example:**

```
{["variable":"Serial Number H","value":"4346"],{"variable":"Serial Number L","value":"1287"},{"variable":"Host Fw Ver","value":"102"}}
```

### 7.1 RECEIVING COMMANDS VIA MQTT

Besides acting as a Publisher, the ClickNGo **CG-WiFi** module can act as a Subscriber, which allows it to receive commands via MQTT protocol. You can thus remotely write values to Modbus registers that have already been configured (see [MQTT CHANNELS](#) section).

#### 7.2.1 SUBSCRIBER TOPIC

- **novus/<sn><sup>3</sup>/command**: Topic for receiving registered variables. You can change this topic.

**Example 1:**

```
{"variable": "SP", "value": "420"}
```

**Example 2 – Sending multiple variables:**

```
{
  "variable": "setpoint",
  "value": "1.031"
},
{
  "variable": "run",
  "value": "1"
}]
```



The variables must be previously registered, and the writing option must be enabled.  
The message received will be transported via Modbus. You can only write to RW registers.

<sup>1</sup> The <sn> refers to the serial number of the equipment. Thus, there will be no conflict of topics in a Broker.

<sup>2</sup> The <sn> refers to the serial number of the equipment. Thus, there will be no conflict of topics in a Broker.

<sup>3</sup> The <sn> refers to the serial number of the equipment. Thus, there will be no conflict of topics in a Broker.

## 8. COMMUNICATING WITH NOVUS CLOUD

**NOVUS Cloud** is a cloud portal that allows you to manage the data registered in the equipment. To connect **N20K48** to **NOVUS Cloud**, you must first:

1. Create an account in **NOVUS Cloud** through the link <https://iot2.novusautomation.com>.
2. Register the equipment in the cloud.
3. Follow the steps below.

The process of creating an account and registering equipment is quite intuitive, but, if you have any questions, the **NOVUS Cloud** manual (available on **NOVUS'** website) shows you how to do it.



The MQTT protocol and NOVUS Cloud feature do not work simultaneously.

### 8.1 LINKING YOUR EQUIPMENT TO NOVUS CLOUD

To make the connection between **QuickTune** software or **QuickTune Mobile** app and **NOVUS Cloud**, you must copy the Token that was generated after it was registered in the cloud. This Token will be displayed in the **N20K48** section of the **Management** screen, available in the **NOVUS Cloud** Web interface, as shown in the figure below:

It is important to note that this was the name given to the equipment in this example. When you register a product, you can name it as you wish.

Token

Figure 3

After copying the Token, run **QuickTune** software or **QuickTune Mobile** app, scan **N20K48** and follow the steps below:

1. In the **Wi-Fi Communication** section, enable the **CG-WiFi ClickNGo** module in the **Enable CG-WiFi module** parameter (see [WI-FI COMMUNICATION](#) section).
2. On this same screen, configure a network connection. That is, set the parameters **Access Point SSID** and **Access Point Password**.
3. In the **MQTT** section, enable the MQTT function in the **Enable MQTT function** parameter (see [MQTT PROTOCOL](#) section).
4. In this same screen, set the **Cloud Type** parameter to **NOVUS Cloud** (see [NOVUS CLOUD](#) section).
5. Enter the Token in the **Device Token** parameter.

Once this is done, before sending the configuration to **N20K48**, you need to add the variables to be monitored, as shown in the [MQTT CHANNELS](#) section. And, after adding the variables, finally click the **Send to device** button.



To enable **N20K48** to register variables through **NOVUS Cloud**, it is essential that you have created and linked the tags to the desired registers. Otherwise, you will not be able to link registers to Widgets and no values will be displayed in **NOVUS Cloud**.

Therefore, from this section, when following the logical order of the process, you should proceed to the [MQTT CHANNELS](#) section, as explained above.

## 8.2 REGISTERING VARIABLES IN NOVUS CLOUD

To view in **NOVUS Cloud** the variables created in **QuickTune** (see [MQTT CHANNELS](#) section to better understand the process of creating tags), you must first create a dashboard for the equipment. To create a dashboard, follow the steps below:

1. Access the **Management** screen.
2. Enter the **Create Dashboards and Widgets** section.
3. In the **Dashboard List** section of this screen, click the **Create Dashboard** button.
4. After creating the dashboard, you must finally create the Widgets that refer to it (i.e., the correlations with the tags created in **QuickTune** software or **QuickTune Mobile** app).

The figure below shows a brief description of the process:

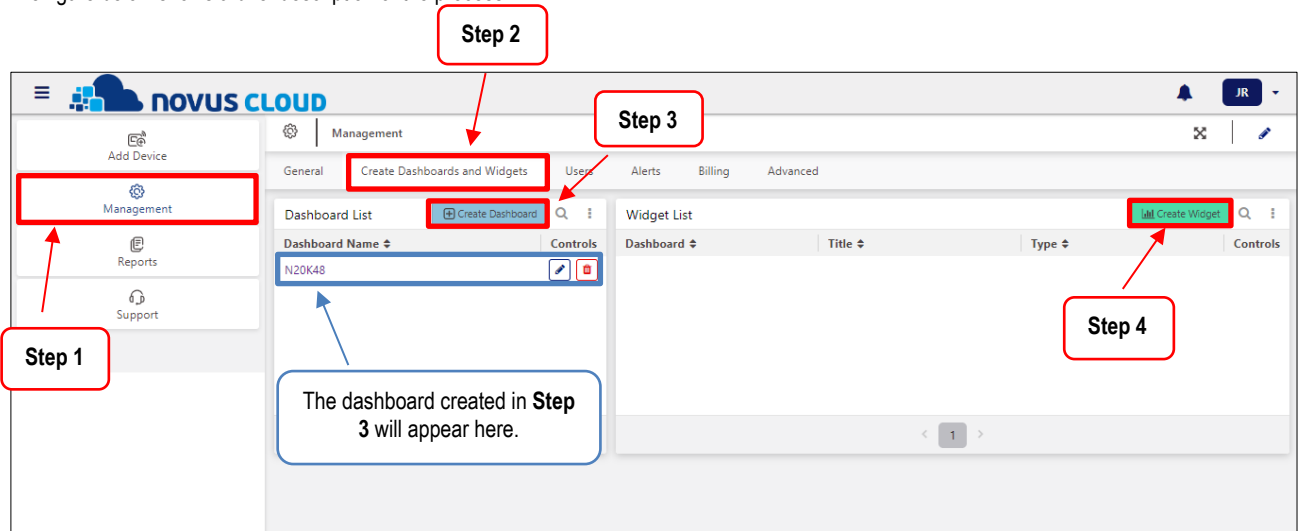

Figure 4

Widgets will allow you to link the registers created in **QuickTune** to **NOVUS Cloud**. It is through them that **NOVUS Cloud** will collect information. When you click on the **Create Widget** button, the following screen will appear:

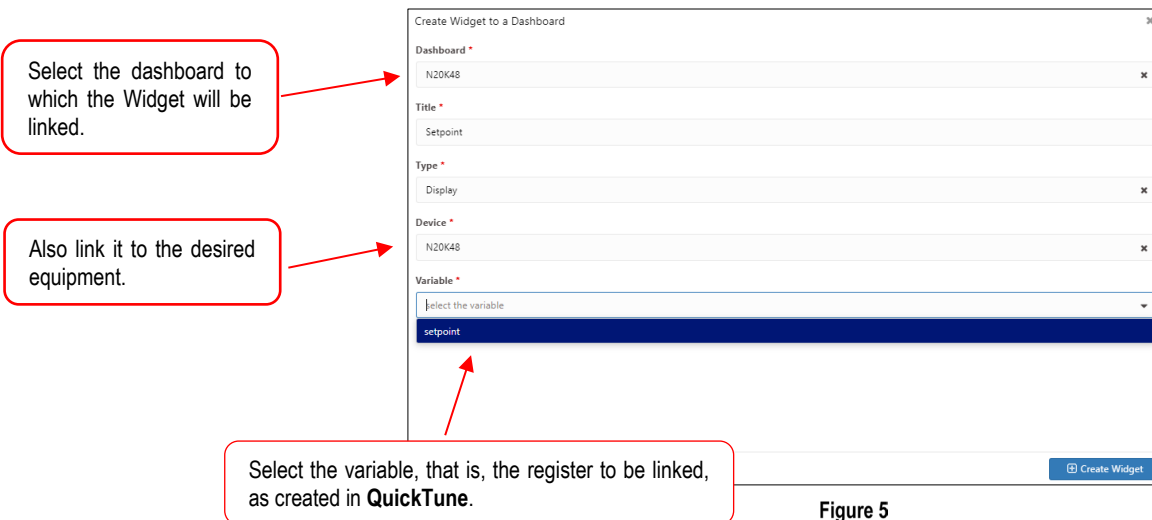

Figure 5

As shown in the example above, it is essential that you have first created the tags for the registers in **QuickTune** software or **QuickTune Mobile** app.

After the Widget is created, simply go into the equipment's dashboard to view it:

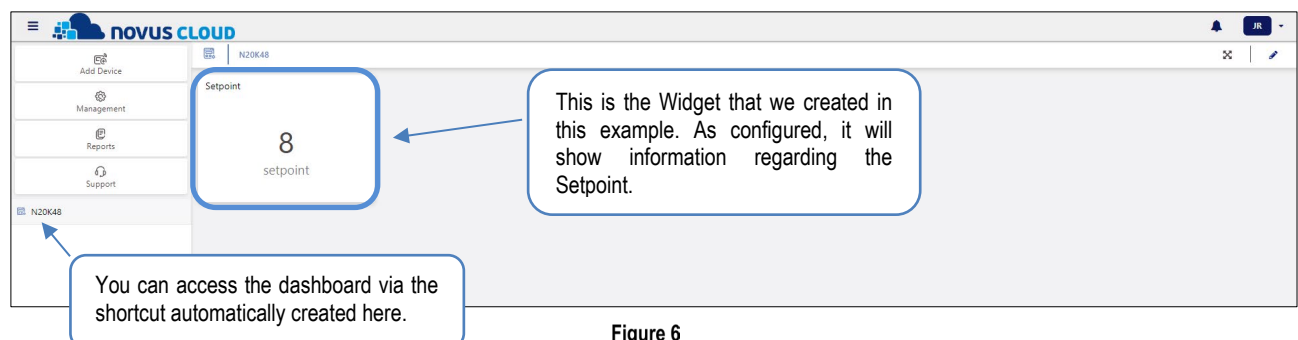

Figure 6



To read and download information from N20K48, the equipment must always be connected to a Wi-Fi network.

## 9. CONFIGURATION SOFTWARE AND APP

After inserting the **CG-WiFi** ClickNGo module in the equipment dock, it can be properly configured either by **QuickTune** software (free of charge and available on **NOVUS'** official website) or by **QuickTune Mobile** app (free of charge and available at *Google Play Store* and *Apple Store*).

Information on the controller primary configuration is available in the CONFIGURATION SOFTWARE chapter of the equipment manual. **This section displays information about how to configure the parameters of this module.**

To start the configuration, simply click the **Configure** button on the home screen of the software or app. If the configuration is performed via **QuickTune Mobile** app, you must enable the Bluetooth interface of the smartphone being used. If the configuration is performed via **QuickTune** software, you must run the software and perform the equipment recognition process.

### 9.1 WI-FI AND MODBUS-TCP COMMUNICATION

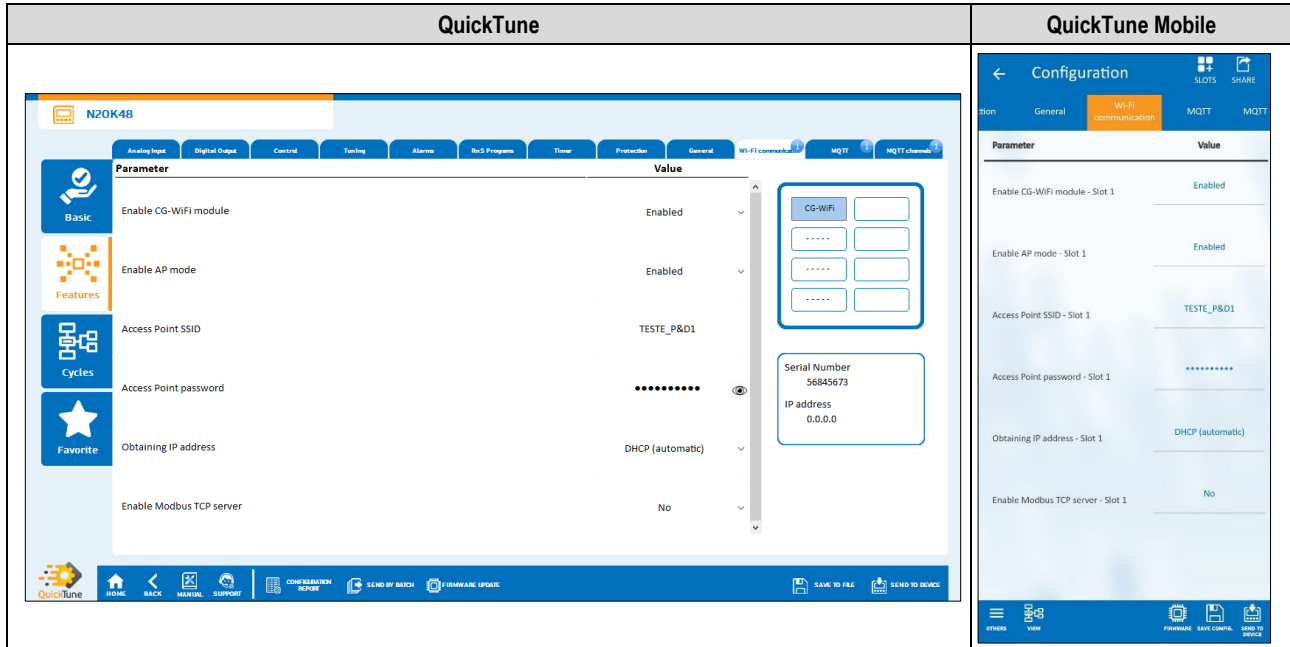

Figure 7

- **Enable CG-WiFi module:** Allows you to enable the communication interface.
- **Enable AP mode:** Allows you to enable the **CG-WiFi** communication mode via Access Point.
- **Access Point SSID:** Allows you to enter the name of the Wi-Fi network to which **CG-WiFi** will try to connect. The field allows up to 32 alphanumeric characters.
- **Access Point Password:** Allows you to enter the password of the Wi-Fi network to which **CG-WiFi** will try to connect. The field allows up to 40 alphanumeric characters.
- **Obtaining IP Address:** Allows you to define the mode by which **CG-WiFi** will attempt to acquire an IP:
  - **DHCP** (Dynamic Host Configuration Protocol): A protocol that allows the equipment's IP (Internet Protocol) to be assigned by the network server.
  - **Static:** Allows you to set the IP address, subnet mask, default Gateway for the connection, and DNS (Domain Name System) server.
    - **IP address Configuration:** Refers to the identification of a device (computer, printer, etc.) on a local or public network. This is a required field when the **Obtaining IP Address** parameter is marked as **Static**.
    - **Subnet Mask Configuration:** Also known as a subnet mask or netmask, it allows you to divide a specific network into smaller subnets, making more effective use of a given IP address space. This is a required field when the **Obtaining IP Address** parameter is marked as **Static**.
    - **Default Gateway Configuration:** Refers to the address of the equipment on the network that connects your computer to the Internet. This is a required field when the **Obtaining IP Address** parameter is marked as **Static**.
    - **DNS Configuration:** Refers to a hierarchical, distributed name management system for computers, services, or any resource connected to the Internet or a private network. This is an optional field when the **Obtaining IP Address** parameter is marked as **Static**.
- **Enable Modbus-TCP server:** Allows you to enable the Modbus-TCP service of the equipment.
  - **Modbus-TCP service port:** Allows you to configure the service port to be used.

## 9.2 MQTT PROTOCOL

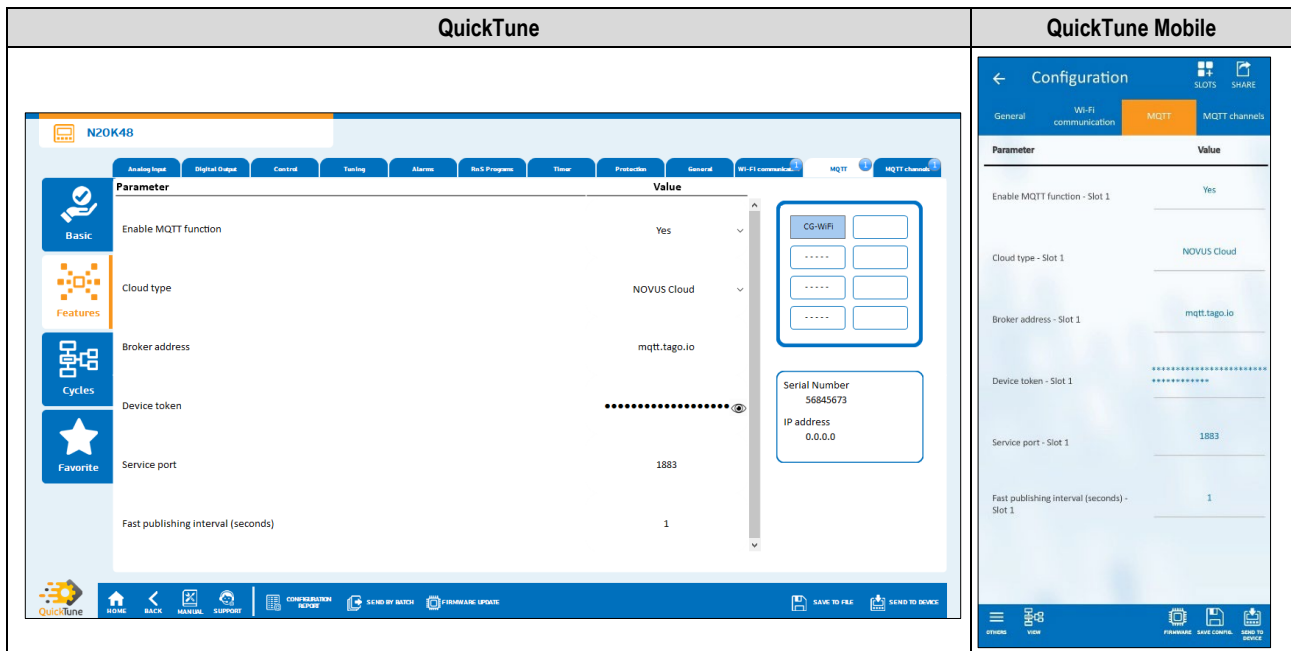

Figure 8

- **Enable MQTT function:** Allows you to send data via MQTT protocol.
- **Cloud Type:** Allows you to select the type of Broker to be used.
  - **Generic Broker:** Allows you to configure a custom Broker (see [MQTT BROKER](#) section).
  - **NOVUS Cloud:** Allows you to configure the **NOVUS Cloud** Broker (see [NOVUS CLOUD](#) chapter).

### 9.2.1 MQTT BROKER

If you select the **Generic Broker** option in the **Cloud Type** parameter, you must configure the following parameters:

- **Broker Address:** Allows you to enter the Broker's address, which can be a URL (Uniform Resource Locator) or an IP. The field allows up to 60 characters.
  - **Broker User:** Allows you to enter the name of the user registered at the Broker. The field allows up to 40 characters. If the field is empty, the connection will be made in anonymous mode.
  - **Broker Password:** Allows you to enter the password of the user registered at the Broker. The field allows up to 40 characters. If the field is empty, the connection will be made in anonymous mode.
  - **Service Port:** Allows you to define the port number to be used when connecting with the Broker.
  - **QoS:** Allows you to select the quality-of-service level to be used when sending MQTT messages. The options are 0, 1, or 2.
  - **Fast publishing topic:** Allows you to modify the fast-publishing topic. The field allows up to 60 characters.
  - **Fast publishing interval:** Informs the time interval at which the data will be published to the cloud by the fast topic. In seconds.
  - **Slow publishing topic:** Allows you to modify the slow-publishing topic. The field allows up to 60 characters.
  - **Slow publishing interval:** Informs the time interval at which the data will be published to the cloud by the slow topic. In seconds.
  - **Enable MQTT writing:** Allows you to enable the sending of MQTT commands.
  - **Subscriber topic:** Allows you to modify the Subscriber topic to receive commands via MQTT. The field allows up to 60 characters.
  - **Security:** Allows you to define the security and data encryption protocol to be used by the MQTT Broker.
    - **None:** No security measures will be used.
    - **TLS V1.2 – CA Only:** If this option is selected, the Broker will use the Transport Layer Security (TLS) 1.2 protocol to ensure data privacy and integrity. This protocol requires a TLS certificate recognized by a certification authority (CA).
    - **TLS V1.2 – Self Signed:** If this option is selected, the Broker will use the Transport Layer Security (TLS) 1.2 protocol to ensure data privacy and integrity. This protocol requires a TLS certificate recognized by a certification authority (CA), the authentication of the client's certificate, and a private key.
- CA certificate, client certificate, and private key files are accepted only in .pem and .der formats.

## 9.2.2 NOVUS CLOUD

If you select the **NOVUS Cloud** option in the **Cloud Type** parameter, you must configure the following parameters:

- **Broker address:** Displays the address of the **NOVUS Cloud** Broker. Non-editable parameter.
- **Device Token:** Allows you to enter the device Token. The Token is generated when registering the product in **NOVUS Cloud**. See [COMMUNICATING WITH NOVUS CLOUD](#) chapter.
- **Service Port:** Displays the service port used. Non-editable parameter.
- **Fast publishing interval (seconds):** Allows you to set the interval for publishing data to the cloud. From 1 to 9999.

## 9.3 MQTT CHANNELS

This screen allows you to assign the variables to be displayed in **NOVUS Cloud** or in the configured Broker. Once created, they can be linked to **NOVUS Cloud** Widgets, which will allow them to be displayed online (see [REGISTERING VARIABLES IN NOVUS CLOUD](#) section).

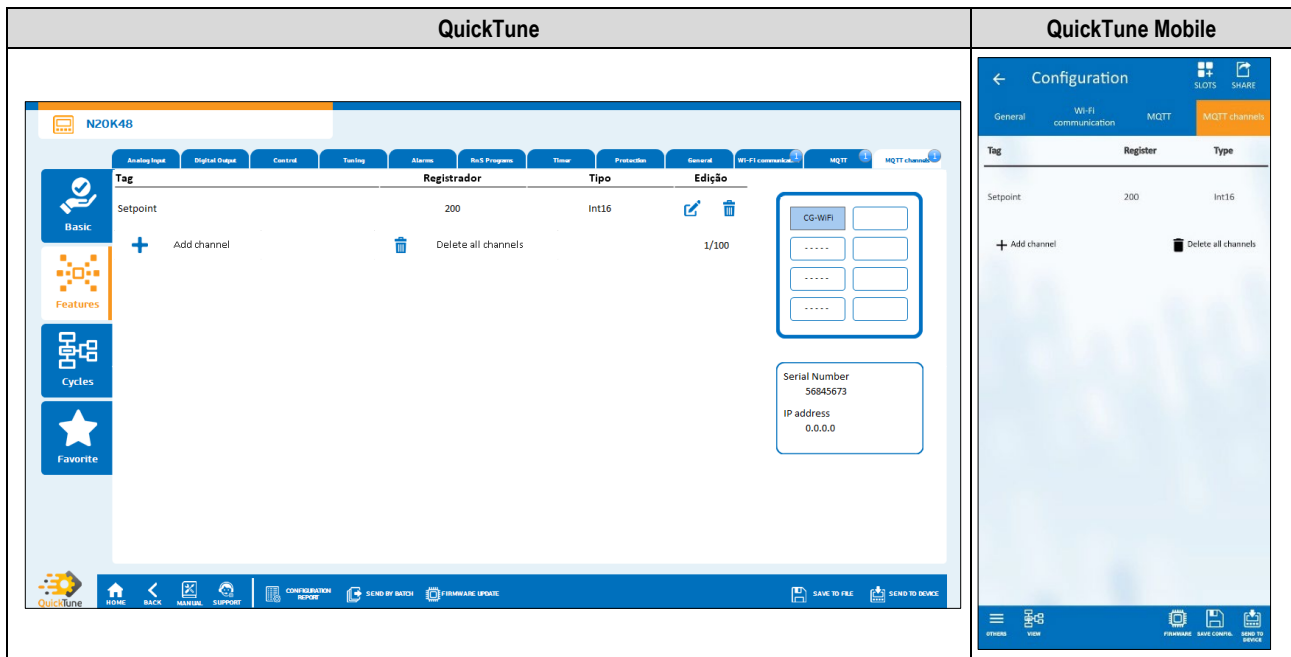

Figure 9

To add a variable, click the **Add Channel** button and configure it, as shown in the example below:

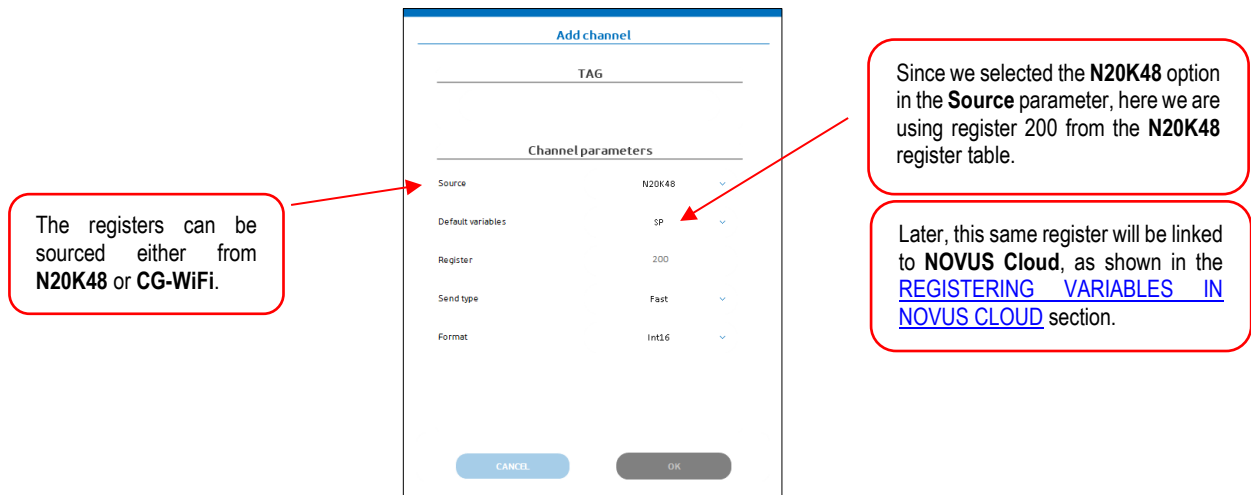

Figure 10

- **Tag:** Allows you to insert the name of the variable that will be published. The field allows up to 15 characters.
- **Source:** Allows you to select the source from which to read the registers.
  - **CG-WiFi:** Reading the **CG-WiFi** internal registers.
  - **HOST:** Reading the **N20K48** registers.
- **Register:** Allows you to enter the address of the corresponding register in the **N20K48's** register table (see the "Communication Protocol" file, available on the product's page) or in the register table of the **CG-WiFi** ClickNGo module itself (see [REGISTERS TABLE](#) section).
- **Send type:** Allows you to select the topic in which the value of the registers will be published.

- **Fast:** Publishing in the NOVUS/<sn><sup>4</sup>/channels/fast topic.
- **Slow:** Publishing in the NOVUS/<sn><sup>5</sup>/channels/slow topic.
- **Format:** Allows you to insert the variable format according to the data output/input.
  - **INT16:** 16-bit integer format.
  - **UNIT16:** Unsigned 16-bit integer format.
  - **FLOAT:** Floating point format with 1, 2 or 3 decimal places.
  - **STRING:** Format containing ASCII characters.
  - **HEX:** Hexadecimal number format.
- **Decimal places:** Allows you to set the number of decimal places to be used when selecting Float format.



Variables that are not listed here can NOT be linked to NOVUS Cloud.

## 9.4 ACCESS POINT CONFIGURATION

To access **N20K48** via Access Point, follow the steps below:

1. Read the **N20K48** configuration via **QuickTune** software or **QuickTune Mobile** app.
2. Access the **Wi-Fi Communication** screen. In this screen, enable the **Enable AP Mode** parameter. It is also possible to enable **Access Point mode** through the equipment itself, by enabling the **R.P.En** parameter.
3. Send the configuration to the equipment.
4. After this, the equipment will create its own internal network. It can be displayed in the Network and Internet section, when accessing the network settings of the computer being used. This network allows any device with a Wi-Fi connection to connect to **N20K48**, as shown in the figure below:

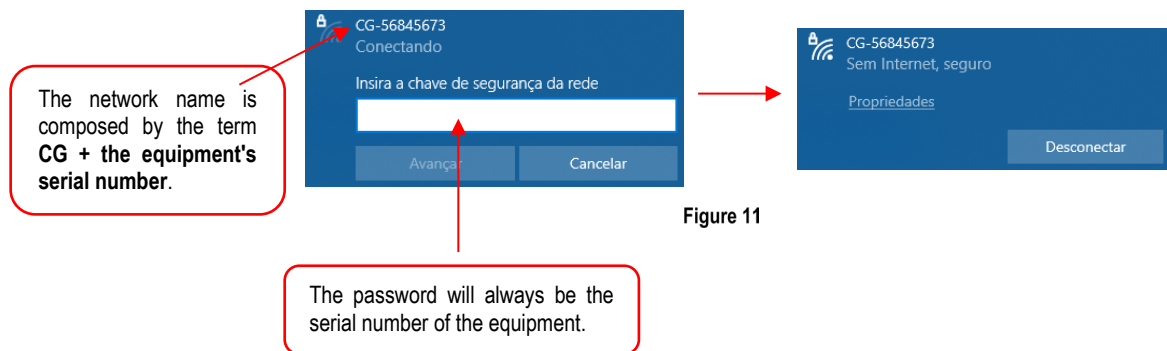

Figure 11

Once the above steps are done, it will be finally possible to connect via AP Mode. From the **QuickTune** software home screen, simply click the **Read Device** button, and, in the **TCP/IP** section, click the button to add a connection, as shown in the figure below:

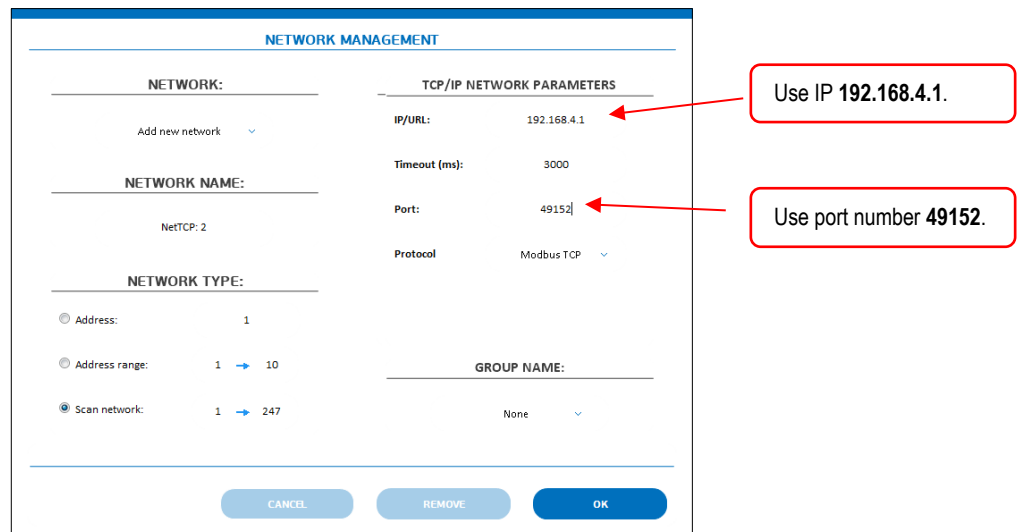

Figure 12

After adding the new network and clicking the **OK** button, **QuickTune** software will display the device icon and can be configured as usual:

<sup>4</sup> The <sn> refers to the serial number of the equipment. Thus, there will be no conflict of topics in a Broker.

<sup>5</sup> The <sn> refers to the serial number of the equipment. Thus, there will be no conflict of topics in a Broker.

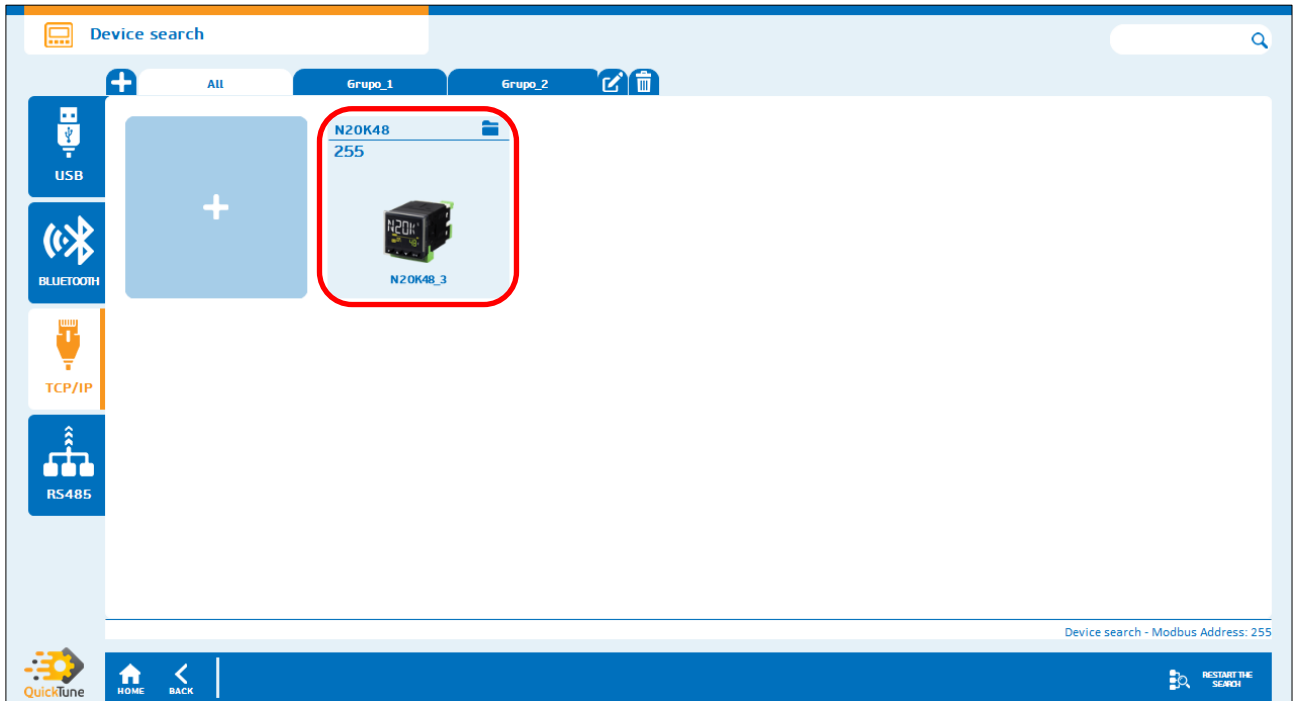

Figure 13

To connect via smartphone, simply connect to the network created by the equipment, run **QuickTune Mobile** app, and change the connection mode to Wi-Fi:

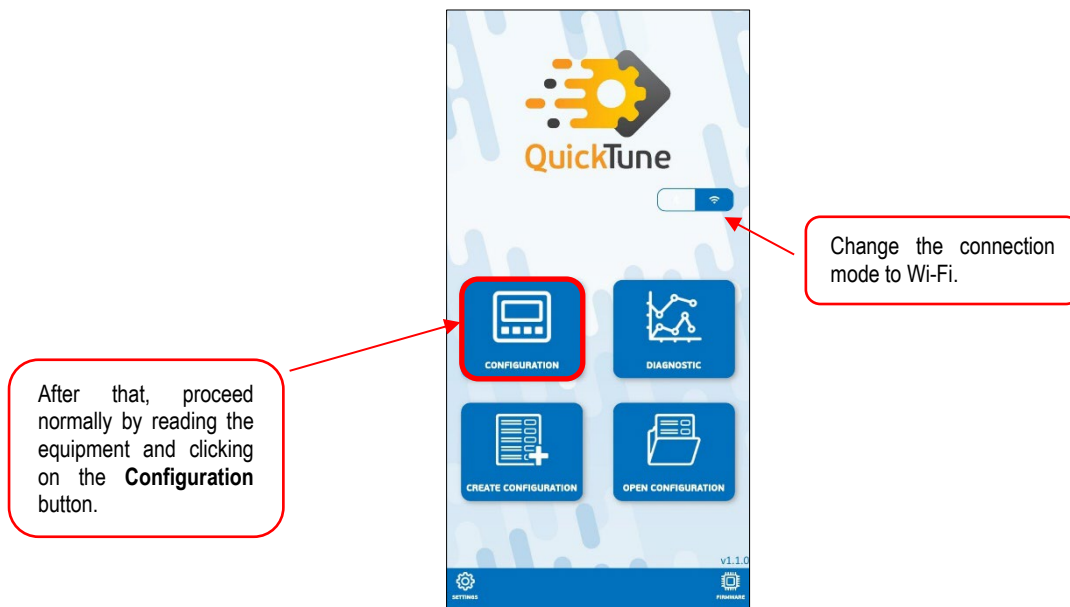

Figure 14



When AP mode is enabled, port 49152 always remains open for Modbus-TCP connections, even if Modbus-TCP itself is disabled.

## 10. FIRMWARE UPDATE

### 10.1 FIRMWARE UPDATE PROCESS

The ClickNGo **CG-WiFi** module can be upgraded using Over the Air technology. To perform this procedure, you should follow the steps below:

- Use a USB cable to connect the **N20K48** to the computer.
- Run the **QuickTune** software.
- Access the configuration section of the connected device.
- In the **CG-WiFi** screen, click on the hyperlink available, as shown in the figure below.

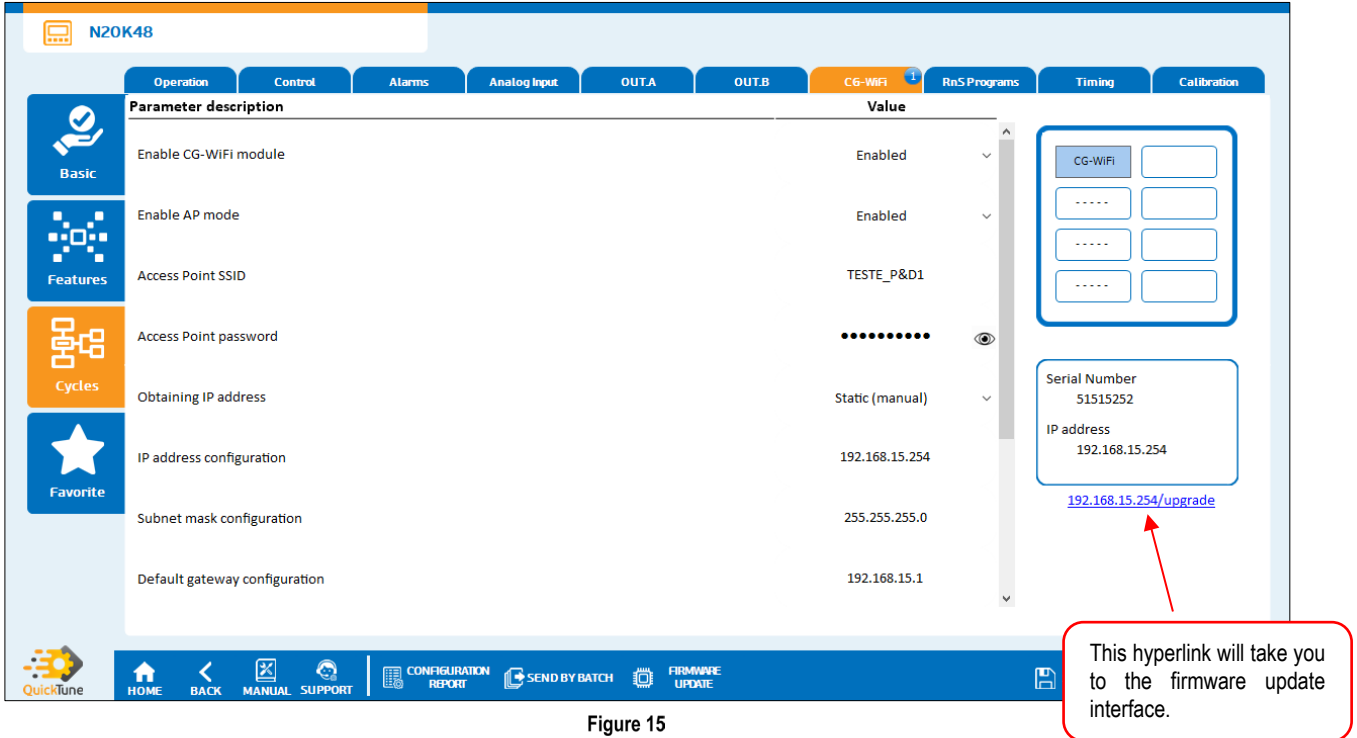

The screenshot shows the configuration interface for the N20K48 device. The 'CG-WiFi' tab is selected. The interface is divided into sections: Basic, Features, Cycles, and Favorite. The 'Basic' section includes parameters like 'Enable CG-WiFi module' (Enabled), 'Enable AP mode' (Enabled), 'Access Point SSID' (TESTE\_P&D1), 'Access Point password' (masked), and 'Obtaining IP address' (Static (manual)). The 'Favorite' section includes 'IP address configuration' (192.168.15.254), 'Subnet mask configuration' (255.255.255.0), and 'Default gateway configuration' (192.168.15.1). A red arrow points to a hyperlink '192.168.15.254/upgrade' located below the IP address configuration. A callout box with a red border contains the text: 'This hyperlink will take you to the firmware update interface.'

Figure 15



To access the firmware update interface, you must connect the N20K48 and the computer you are using to the same network.

By clicking on the link available on the **CG-WiFi** screen, you will be redirected to the firmware update page, which will be opened in the standard browser of the computer used:

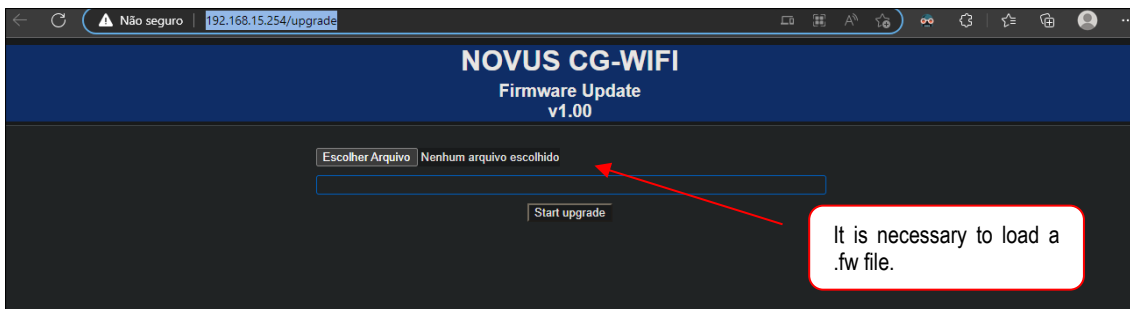

The screenshot shows a web browser window with the address bar displaying '192.168.15.254/upgrade'. The page title is 'NOVUS CG-WIFI Firmware Update v1.00'. Below the title, there is a file selection area with the text 'Escolher Arquivo Nenhum arquivo escolhido' and a 'Start upgrade' button. A red arrow points to the file selection area. A callout box with a red border contains the text: 'It is necessary to load a .fw file.'

Figure 16

The firmware file has a **.fw** extension and is in the **QuickTune\firmware** folder. The **firmware** folder is a subfolder located inside the software installation folder (to access the software installation location, you can click on the **QuickTune** icon and select the **Open file location** option).

When you click the **Start Upgrade** button, the firmware will start upgrading:

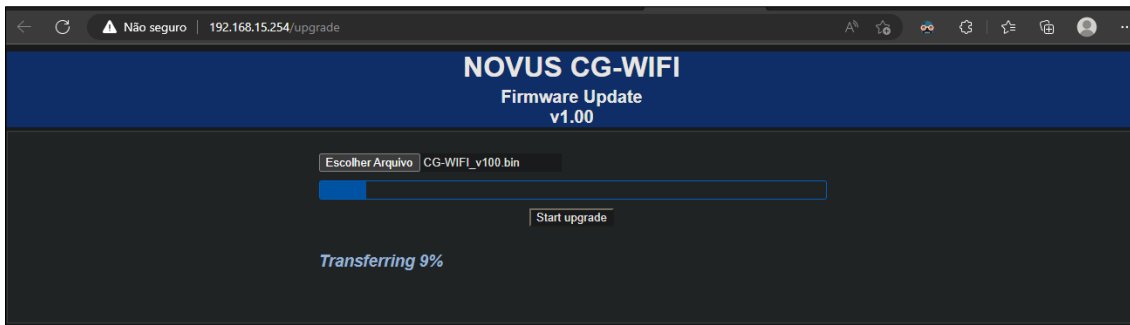

Figure 17

After updating the device, wait a few seconds for the page to reload and display the new firmware version. To ensure the device recognizes the new Wi-Fi module firmware, power off the **CG-WiFi** completely and then power it on again.

In **QuickTune**, select the device, read its parameters, and resend the configuration, even if there are no changes.



1. **Do not remove the device until the upgrade process has been completed!**
2. **For updates from version 1.02 to 1.10, users of a generic MQTT Broker must manually add the three publish/subscribe topics in QuickTune.**

## 10.2 FIRMWARE UPDATE FOR GENERIC-BROKER USERS – V1.02 TO V1.10

### 10.2.1 OVERVIEW

After the firmware update from version 1.02 to 1.10, cloud-command and MQTT-topic-editing features were added. Because these fields did not exist in v1.02, generic-broker users must configure the new topics manually in **QuickTune**.

### 10.2.2 UPDATE STEPS

#### FIRMWARE UPDATE:

1. Update the firmware using the standard method (see [FIRMWARE UPDATE PROCESS](#) section).
2. After the update is completed, wait a few seconds for the device's web page to refresh and show the new version.

#### CG-WIFI REBOOT:

3. Power off the **CG-WiFi** module completely.
4. Power it back on so it loads the new Wi-Fi firmware.

#### CONFIGURATION RESEND:

5. In **QuickTune**, select the device, read its parameters, and resend the configuration (even if unchanged).

### 10.2.3 MANUAL MQTT-TOPIC CONFIGURATION (GENERIC BROKER ONLY)

Allows you to manually configure the three MQTT topics in **QuickTune**:

1. Open the **MQTT** tab on the **N20K48** configuration screen.
2. Enter the 3 topics manually, as shown in the figure below (for more information on the topics, see [MQTT PROTOCOL](#) chapter):
  - **Fast-publishing topic**
  - **Slow-publishing topic**
  - **Subscriber topic**

Parameter description	Value
QoS	QoS 0
Fast publishing topic	novus/12345678/channels/f
Fast publishing interval (seconds)	1
Slow publishing topic	novus/12345678/channels/s
Slow publishing interval (minutes)	1
Enable MQTT writing	Yes
Subscriber topic	novus/12345678/command
Security	None

Figure 18

 This step is only mandatory for those who upgrade their firmware from version 1.02 to version 1.10 with a generic Broker.

## 11. MAINTENANCE

Connection errors and improper programming are the most common errors during controller operation. A final review can avoid wasted time and damage.

If the module is not recognized by the device, you must remove it from the dock, add it to another available slot, and restart the device.

## 12. TECHNICAL SPECIFICATIONS

FEATURES	CG-WIFI CLICKNGO MODULE	
Antenna connections	RP-SMA Female Connector	
Environmental conditions	Operating temperature: -20 to 60 °C (-4 to 140 °F) Relative Humidity: 80 % max. @ 30 °C (86 °F) (For temperatures above 30 °C (86 °F), reduce by 3 % for each °C) Internal use Installation category II, Pollution degree 2; Altitude < 2000 m	
Electrical compatibility	EN 61326-1:2020	
Security	EN 61010-1:2010 UL 61010-1/A2:2012	
Wi-Fi connection	<b>WLAN Standards</b>	IEEE 802 part 11/b/g/n (802.11b/g/n)
	<b>Antenna port</b>	Supports a single Wi-Fi antenna
	<b>Frequency band</b>	2.400 ~2.484 GHz
Dimensions	53.1 x 42.1 x 22.2 mm Approximated weight: 30 g	
Protection index	IP50 when installed in controller.	
Plastic material	ABS+PC UL94 V-0	
Software	<b>QuickTune</b> (for PC) <b>QuickTune Mobile</b> (for smartphones)	
Certifications	CE, Anatel (09263-23-07089), FCC, IC	

Table 5

### 12.1 CERTIFICATIONS

#### CE Mark

This is a Class A product. In a domestic environment, this product may cause radio interference in which case the user may be required to take adequate measures.

#### ANATEL

This device is homologated by ANATEL, according to the regulated procedures for conformity assessment of telecommunications products, and meets the technical requirements applied.

This equipment is not subject to the protection from harmful interference and may not cause interference with duly authorized systems.

For more information, see the ANATEL website [www.anatel.gov.br](http://www.anatel.gov.br).

#### FCC

Contains FCC ID: 2AC72-ESP32WROOM32U

This equipment has been tested and found to comply with the limits for a Class A digital device, pursuant to Part 15 of the FCC Rules. These limits are designed to provide reasonable protection against harmful interference when the equipment is operated in a commercial environment. This equipment generates, uses, and can radiate radio frequency energy and, if not installed and used in accordance with the instruction manual, may cause harmful interference to radio communications.

Any changes or modifications not expressly approved by the party responsible for compliance could void the user's authority to operate this equipment.

**RF Exposure:** A distance of 20 cm shall be maintained between the antenna and users, and the transmitter module may not be co-located with any other transmitter or antenna.

This device complies with part 15 of the FCC Rules. Operation is subject to the following two conditions: (1) This device may not cause harmful interference, and (2) this device must accept any interference received, including interference that may cause undesired operation.

#### IC

Contains IC: 21098-ESPWROOM32U

This device complies with Industry Canada's license exempt RSS standard(s). Operation is subject to the following two conditions:

- (1) This device may not cause interference, and
- (2) This device must accept any interference, including interference that may cause undesired operation of the device.

The installation of the transmitter must ensure that the antenna has a separation distance of at least 6.5 cm from all people or compliance must be demonstrated according to the ISED SAR procedure.

## 13. WARRANTY

Warranty conditions are available on our website [www.novusautomation.com/warranty](http://www.novusautomation.com/warranty).