



AirGate-GPRS

INSTRUCTION MANUAL

V1.0x

INTRODUCTION.....	3
TYPICAL APPLICATIONS	4
SPECIFICATIONS	7
CONNECTIONS AND INSTALLATION.....	8
MECHANICAL INSTALLATION.....	8
DIMENSIONS	8
OPENING THE <i>AIRGATE-GPRS</i>	8
ELECTRICAL INSTALLATIONS.....	9
INSTALLATION RECOMMENDATIONS	9
POWER SOURCE	9
RS485.....	9
INPUTS.....	11
USB INTERFACE	12
GPRS INTERFACE	12
SIGNAL LIGHT (LED)	13
USB DRIVER INSTALLATION.....	14
WINDOWS 8	14
DEFINITION AND SELECTION OF SERIAL PORT (COM) - WINDOWS.....	19
CONFIGURATION SOFTWARE	20
EQUIPMENT SOFTWARE (FIRMWARE) UPDATE.....	20
<i>AIRGATE-GPRS</i> OPERATION	21
GPRS INTERFACE	21
AUTHENTICATION AND OTHER DETAILS.....	21
WITHOUT AUTHENTICATION	21
OPEN AUTHENTICATION.....	21
NAP	21
ANALOG OR DIGITAL INPUT.....	21
RS485 INTERFACES.....	22
RS485 - 1.....	23
RS485 - 2.....	23
REMOTE CHANNELS.....	23
USB INTERFACE.....	24
SENDING SMS – ALARMS AND STATUS	24
ALARMS	24
SMS EXAMPLES.....	25
DATA COMMUNICATION AND ROUTING	25
ROUTING	26
ONE RS485 MASTER INTERFACE	26
TWO RS485 MASTER INTERFACES	26
MODBUS COMMANDS AND REGISTERS TABLE.....	27
SUPPORTED MODBUS COMMANDS	27
READ HOLDING REGISTERS – 03H	27
WRITE SINGLE REGISTER – 06H	27
WRITE MULTIPLE REGISTERS – 16H.....	27
TABLE OF HOLDING REGISTERS	27
DETAILS ABOUT SOME REGISTERS	28
REGISTERS 0 AND 1 - SERIAL NUMBER	28
REGISTER 2 – FIRMWARE VERSION	28
REGISTERS 3 AND 4 – VALUE OF THE ANALOG/DIGITAL CHANNEL	28
REGISTERS 5 TO 14 – VALUE OF REMOTE CHANNEL	28

REGISTERS 31 TO 45 – SIM CARD IDENTIFICATION	28
REGISTER 46 – GSM SIGNAL LEVEL	28
REGISTER 51 – STATUS 1.....	28
REGISTER 52 – STATUS 2.....	28
WARRANTY.....	29

INTRODUCTION

Ideal for machine to machine (M2M) telemetric applications, the **AirGate-GPRS** allows for the supervision of a network with Modbus serial communication for more than one master. One of the masters can be remote, communicating using a TCP/IP connection on GPRS using the cloud. Another master can be locally connected supervisory software. The second RS485 interface can be configured as a Modbus slave, allowing a third master, such as a local IHM, to access the slaves, or as a Modbus master, allowing a new branch of the network with more slaves communicating. The routing of Modbus packets between the interfaces ensures the original performance of the network, even with other functionalities turned on. Besides the gateway functionality, the **AirGate-GPRS** signals monitored alarms of Modbus registers of the slaves connected to one of the interfaces.



Internet or cell phone based services, like data communication and text messages, are subject to failures, delays and interruptions and do not offer any guarantees of success for these services. Always consider the failure possibility when specifying, designing or building a monitoring, alarm or control system based on these services. NOVUS will not be responsible for third-party services that may be ceased or interrupted at any time, and it cannot guarantee their integrity or availability for any period of time. The usage of such services can generate exceeding costs, according to the one hired with the service provider. NOVUS will not be responsible for any fixed or additional costs referring to any service usage.

Avoid using prepaid and pay-per-use plans, either for data or text-messaging, since these plans can bring severe performance limitations that are not easily predicted.

TYPICAL APPLICATIONS

Below are examples of some **AirGate-GPRS** applications:

1. Remote monitoring without local monitoring

With this application, the **AirGate-GPRS** allows remote access to the data of the Modbus RTU network using the cellular network (GSM/GPRS) and the sending of alarm and status messages (SMS).

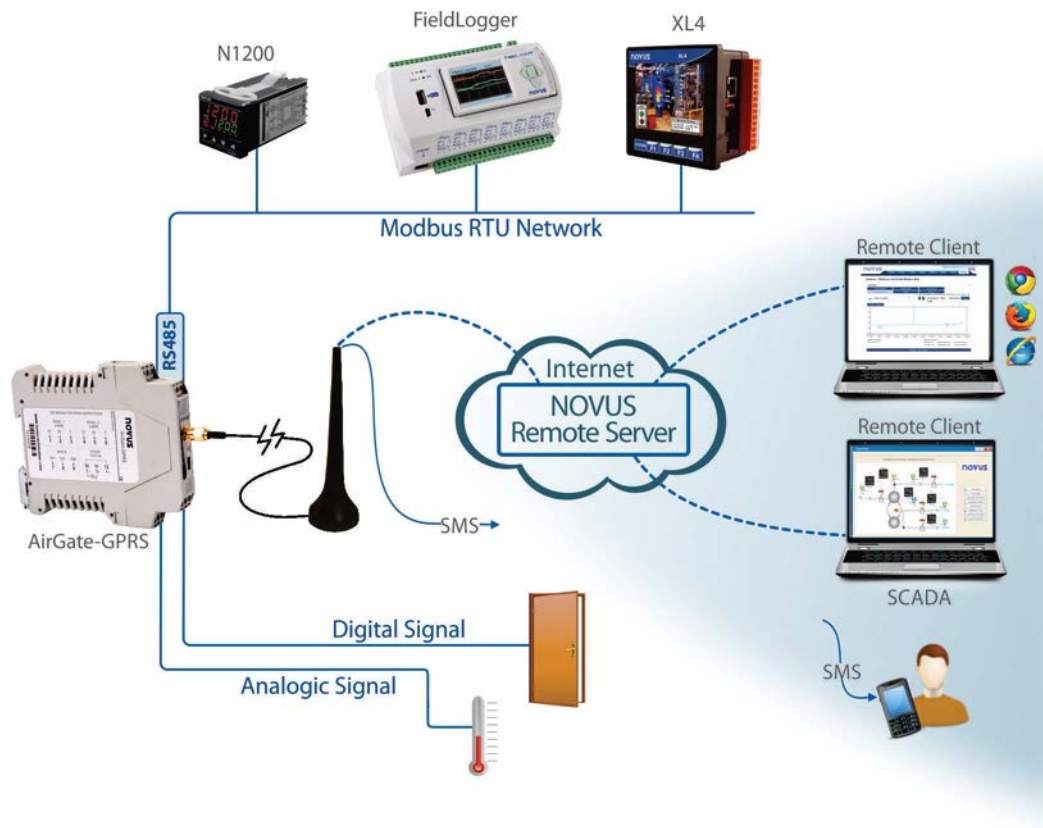

2. Remote monitoring with local monitoring

In this application, **AirGate-GPRS** is inserted in a Modbus network that needs local supervision (often it is an existing Modbus network). Besides performing the role of a USB-RS485 converter, it allows remote access to data from the Modbus RTU network using the cellular network (GSM/GPRS) and the sending of alarm and status messages (SMS).

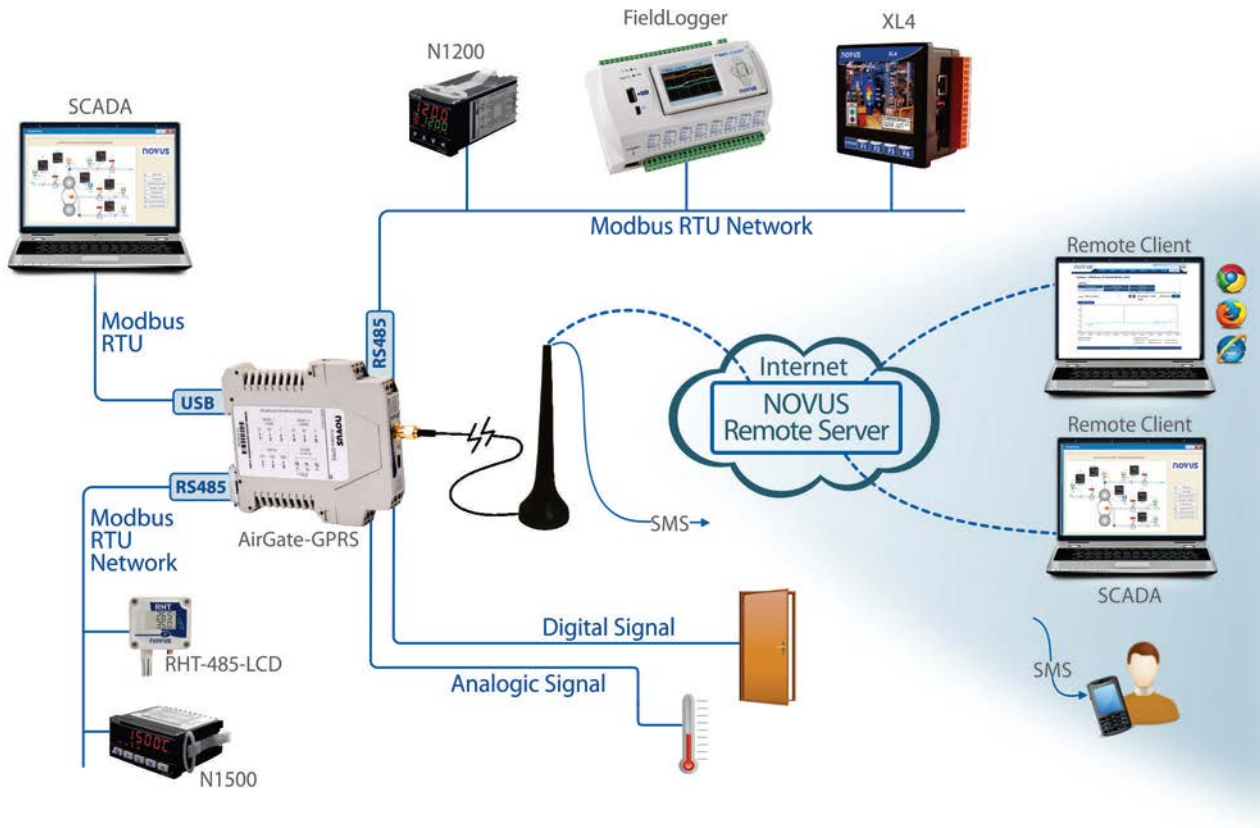

3. Remote monitoring with double local monitoring

In this application, the *AirGate-GPRS* is inserted in a Modbus network that needs local supervision of two Modbus masters: normally a Supervisory software (SCADA) and an IHM or local CLP. Not only does it allow for the use of two masters in the same network due to the capacity for routing the packets, it allows for remote access to data of the Modbus RTU network using a cellular network (GSM/GPRS) and the sending of alarm and status messages (SMS).

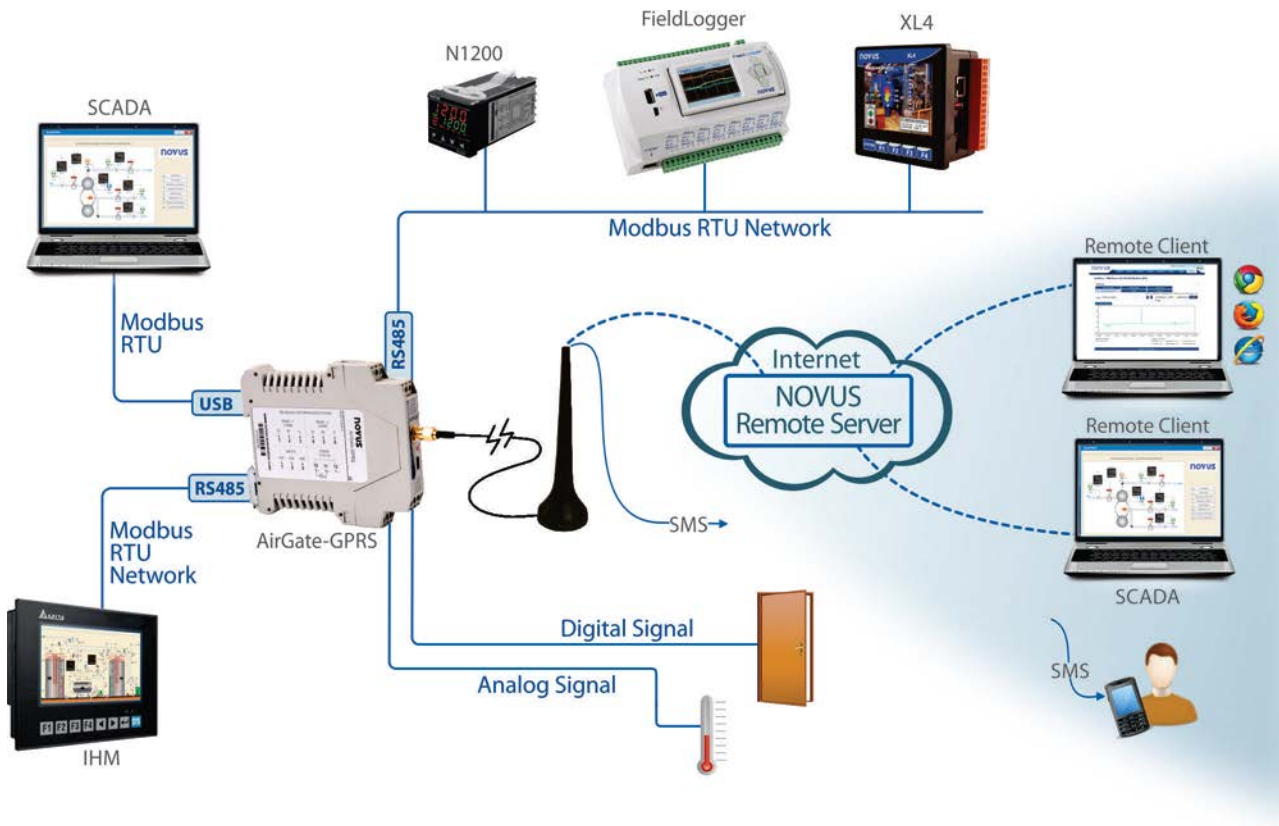

4. Remote monitoring using only SMS

In this application, the *AirGate-GPRS* can either be or not be inserted in a Modbus network. The monitoring of the desired variables is made only by text messages that state the periodic status of a few variables and alarm type conditions.

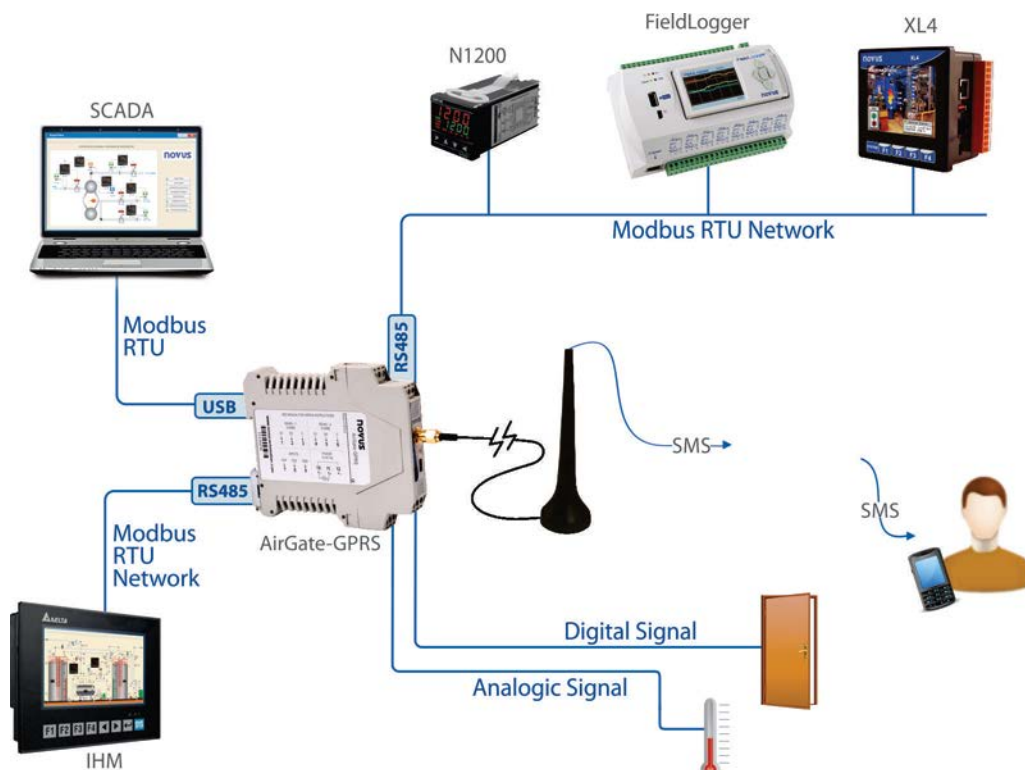

SPECIFICATIONS

Power Supply: 10 to 35 Vcc. Maximum consumption: 150 mA @ 24 V.

Environmental Conditions: Operation Temperature: -10 to 50 °C. Relative Humidity: 80 % up to 30 °C. For temperatures higher than 30 °C, lower 3 % per °C.

Internal use.

Installation category II.

Pollution level II.

Altitude < 2000 m.

Dimensions: 114 x 99.5 x 17.5 mm

Weight:

- Without antenna: 114 g
- With antenna: 174 g

Enclosure: PA66, with metallic attachment for 35 mm DIN track.

Internal protection against polarity inversion of the power supply voltage.

Wire section used: AWG 28 a 12.

Recommended torque: 4 kgf.cm.

Analog Entries:

The types of entry signals accepted by **AirGate-GPRS** and their minimum measurement bands are selected in the Configuration software and are listed in the following table.

TYPE OF INPUT	MEASUREMENT RANGE	EXACTNESS
Linear 4 to 20 mA	Configurable	± 1.0 % (F.E.) *
Linear 0 to 10 V	Configurable	± 1.0 % (F.E.) *

F.E. = Scale Background = Span

(*) Note: the background scale is in regards to the input of the sensor's signal and not the configured recommended range.

Table 01 – List of signals accepted by **AirGate-GPRS**

Although the analog inputs can recommend a bit beyond the limits of the configured range, the specification is not guaranteed outside the range.

Impedance of the analog channel input:

- mA: 150 Ω + 1.5 V
- V: 670 kΩ

Digital Entries:

- Logical level "0": from 0 to 0.8 Vdc
- Logical level "1": from 2 to 6 Vdc

GPRS Interface:

GSM/GPRS Technology, class 8 to 12 (GPRS device class B)

Quad Band GSM operation range (850 MHz, 900 MHz, 1800 MHz and 1900 MHz)

Output power:

- 1 W (GSM 1800/1900)
- 2 W (EGSM 850/900)

RF Tx Power: +30 dBm

RF Rx Sensibility: better than -100 dBm

Output for antenna GSM: impedance 50 Ω, SMA plug

USB Interface:

Mini-B type USB connector. Compatible with USB 3.0, 2.0 and 1.1.

Isolation of 600 V between the USB interface and the rest of the circuit (power, RS485 and analog/digital inputs).

Certifications: ANATEL (1534-13-7089)

CONNECTIONS AND INSTALLATION

MECHANICAL INSTALLATION

The **AirGate-GPRS** has its own cabinet to be installed on a 35 mm track.

For the installation on the track, the metallic hook should be placed on the base and pressed against the track.

DIMENSIONS

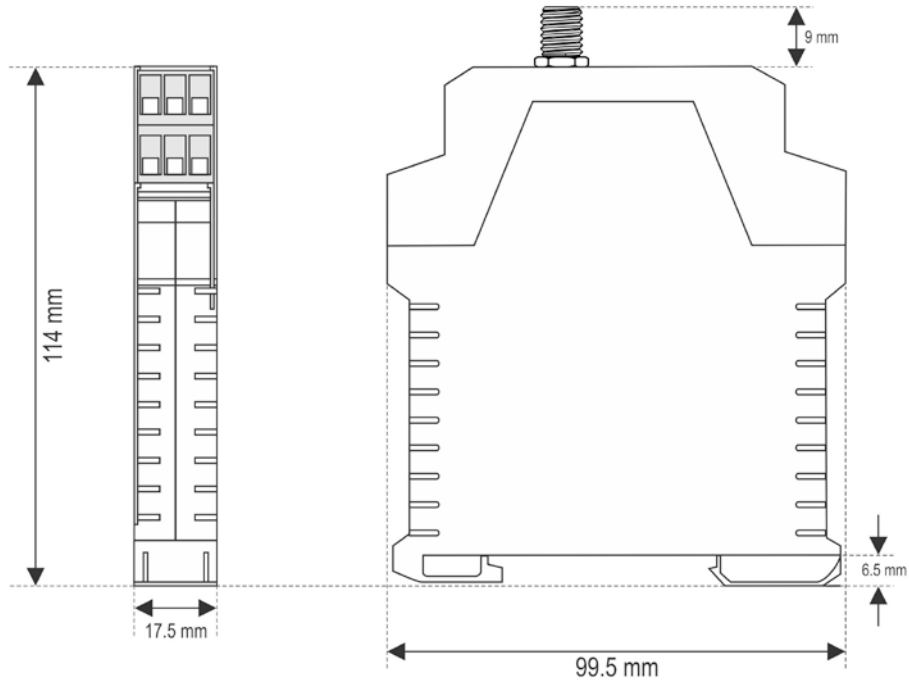

Fig. 01 – Dimensions of the **AirGate-GPRS**

OPENING THE AIRGATE-GPRS

In order to open the **AirGate-GPRS**, you must press the orange lockers located on both sides of the enclosure and pull the frontal cover very carefully, just like shown in Fig. 02.

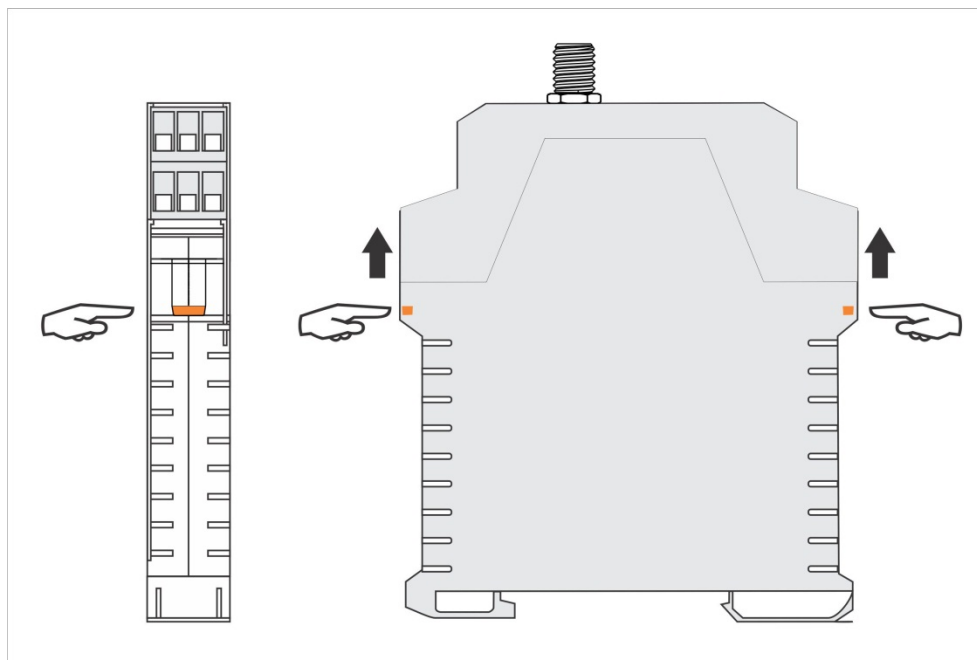



Fig. 02 – Opening the **AirGate-GPRS**

ELECTRICAL INSTALLATIONS

The **AirGate-GPRS** has power source connectors for inputs and RS485 serial communication interfaces.

	<p>Be careful when connecting the power source wires to the AirGate-GPRS. If the positive conductor of the power source is turned on, even for an instant, to one of the communication connection terminals, the AirGate-GPRS can be damaged.</p>
---	---

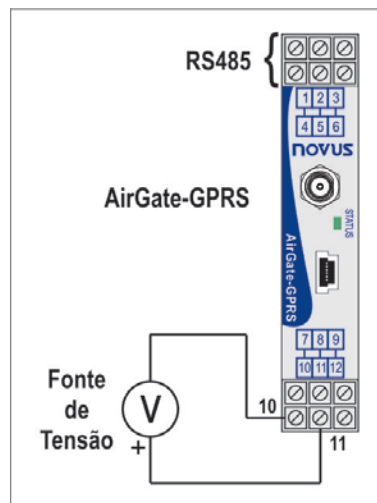

Fig. 03 - Power source and communication connections of the **AirGate-GPRS**

Fig. 04 shows the required electrical connections. Terminals 1, 2, and 3 belong to the first interface RS485/Modbus (RS485-1), while terminals 4, 5, and 6 belong to the second interface RS485/Modbus (RS485-2). Terminals 7, 8, and 9 are for the inputs (analog or digital) of the equipment. Terminals 10, 11, and 12 are used to feed the **AirGate-GPRS**.

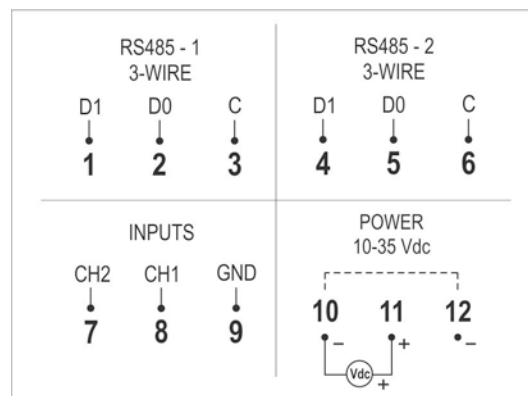

Fig. 04 – Electrical connections of the **AirGate-GPRS**

INSTALLATION RECOMMENDATIONS

- Input conductors should travel the system plant separately from the output and supply conductors, in grounded electrical ducts.
- The power source of the instruments should come from a network that is appropriate for the instrumentation.
- The use of RC FILTERS (47 Ω and 100 nF, in series) parallel to the contactor coils and solenoids that are near or connected to the equipment is recommended.
- In control applications, it is essential to consider what can happen when any part of the system fails. The relays of output RL1 and RL2, used as alarms, do not guarantee total protection.
- Section of used wires: minimum gauge of 0.14 mm².

POWER SOURCE

Terminals 11 and 10 must be connected to the **AirGate-GPRS** power supply. Power supply polarity should be noticed.

RS485

The RS485 interfaces of the **AirGate-GPRS** have terminals for communication with 3 wires, including the common. The wiring to the Modbus networks will depend whether each interface is configured to operate as a master or slave.

- Master

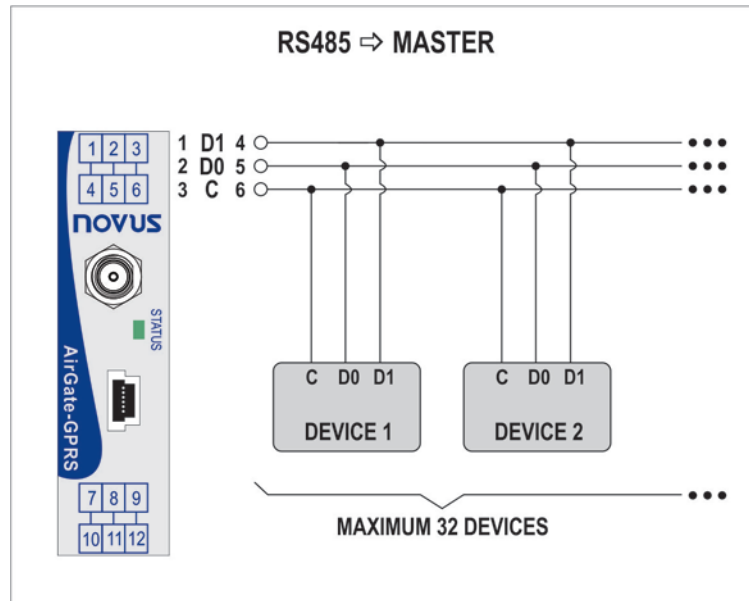

- Slave

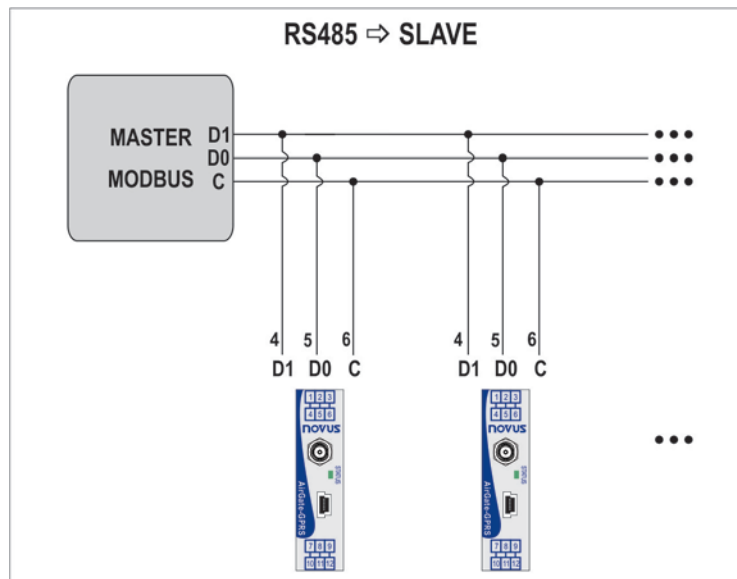

INPUTS

There are two input channels that can be individually configured using internal jumpers such as input 4-20 mA, input 0-10 V or digital input. There is no insulation between channels.

The jumper access requires the opening of the **AirGate-GPRS**. Their location can be seen in the following illustration:

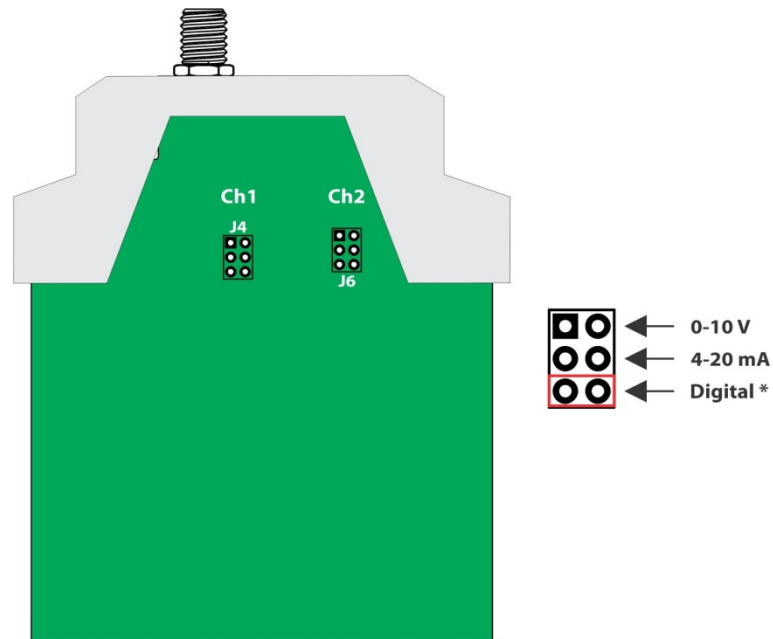

* The **AirGate-GPRS** is factory configured as a digital input in both channels.

Digital Signal Wiring

When configured as a digital input, it can be connected to a voltage output (check the acceptable levels in the *Specifications* section), a dry-contact output or a NPN output. Be careful when connecting multiple outputs due to the lack of insulation between the **AirGate-GPRS** inputs.

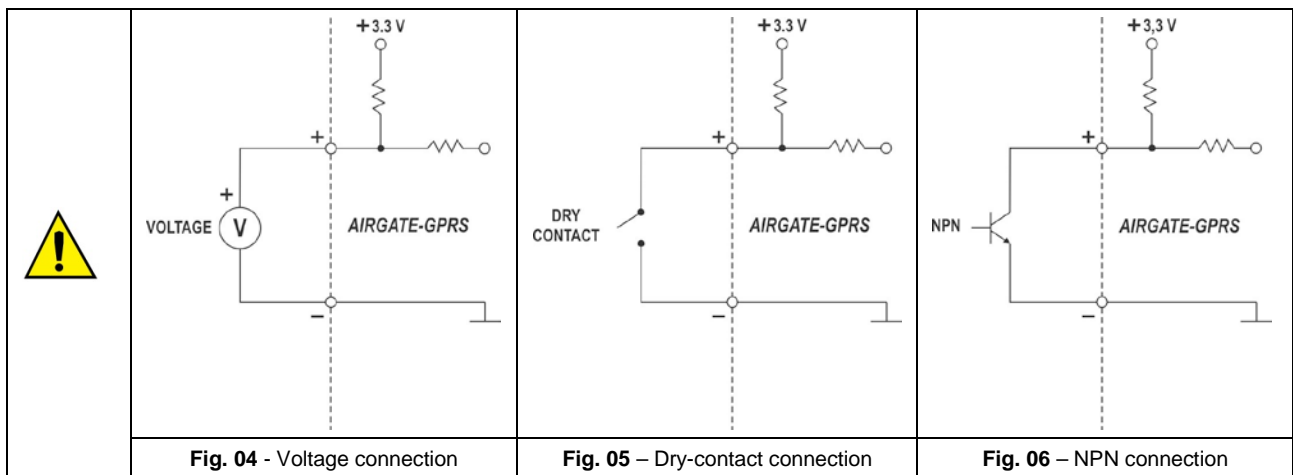

Connection Current (mA)

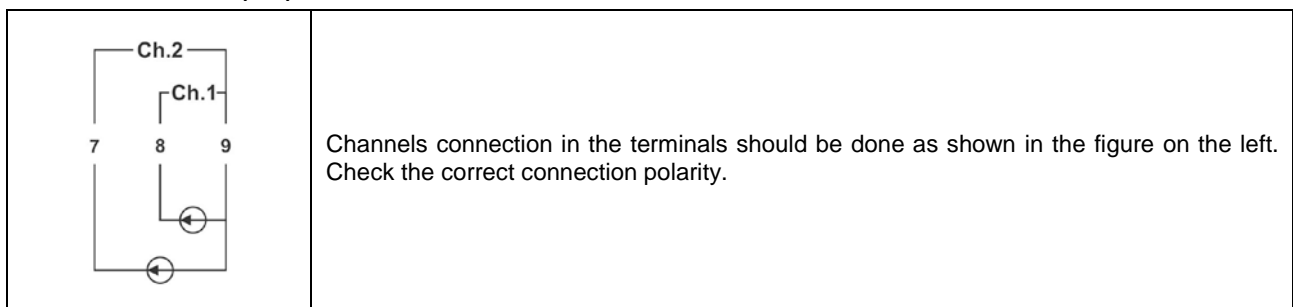

Voltage connection (V)

	<p>Channels connection in the terminals should be done as shown in the figure on the left. Check the correct connection polarity.</p>
--	---

USB INTERFACE

The **AirGate-GPRS** has a USB interface that can be connected to a computer for configuring or monitoring. The USB cable is supplied along with the equipment.

GPRS INTERFACE

This interface requires a compatible antenna, supplied with the equipment, to be connected at the external SMA plug. Internally, the user should insert a SIM card from any operator in the corresponding connector.

	<p>Never remove or insert a SIM card from the AirGate-GPRS while it is turned on.</p>
--	--

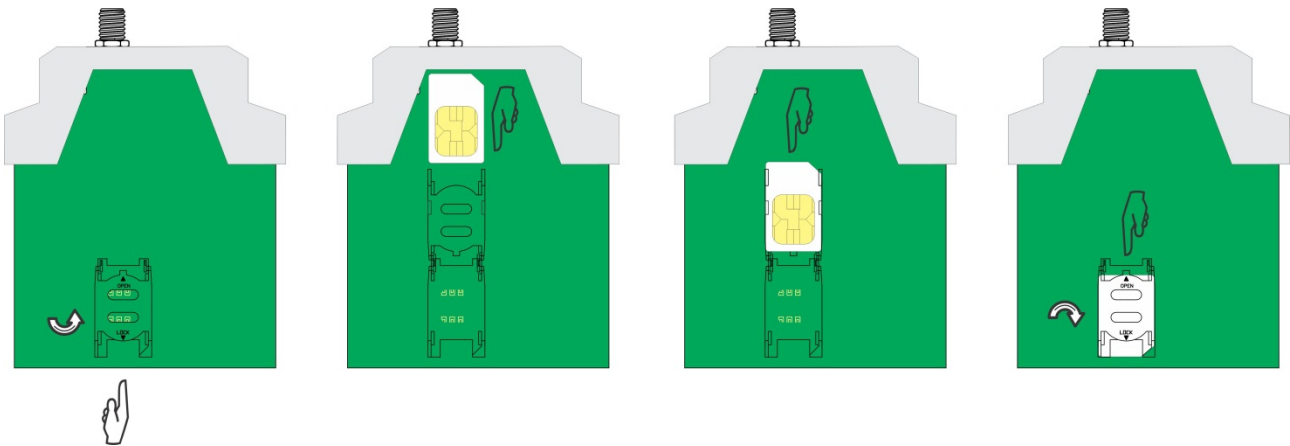

SIGNAL LIGHT (LED)

STATUS

Signal for GPRS Connection Status: 

Upon powering on the equipment, the led remains turned off until the start-up is completed. The signal will occur in the following manner:

- The led will flash slowly during the GSM network access process;
- The led will flash rapidly when it connects to the GSM network;
- The led will flash twice rapidly when the connection with the remote server is established.



After powered, **AirGate-GPRS** led can take a few seconds to start flashing!

USB DRIVER INSTALLATION

In order to use the USB interface of the **AirGate-GPRS** (so you can configure the equipment with the configuration software, for example), it is necessary to install its USB driver. The installation steps can vary from computer to computer, between different operating systems, and even between one version and another of the same operating system.

	<p>Windows 8 (64 bits) does not allow the installation of drivers that are not “digitally signed” by Microsoft. Thus, before installing the USB drivers of the AirGate-GPRS, the following script should be followed:</p> <ol style="list-style-type: none"> 1. During the boot, you should press the F8 key to enter the Start-up Configurations. 2. Pressing the F7 key, you can disable the Imposition of the Driver Signature. 3. Windows 8 will now allow you to install the USB driver for AirGate-GPRS.
---	---

Following are the steps and guidance screens for the driver installation.

WINDOWS 8

1. Connect the **AirGate-GPRS** in a USB port on your computer. Windows will try to install a driver automatically and will not succeed, because the necessary driver is not in its standard library.
2. On Desktop screen, right-click on the left-bottom corner of the screen and choose the "Control Panel" option. Then choose the “System and Security” option, then the "System" option and, at last, "Device Manager".

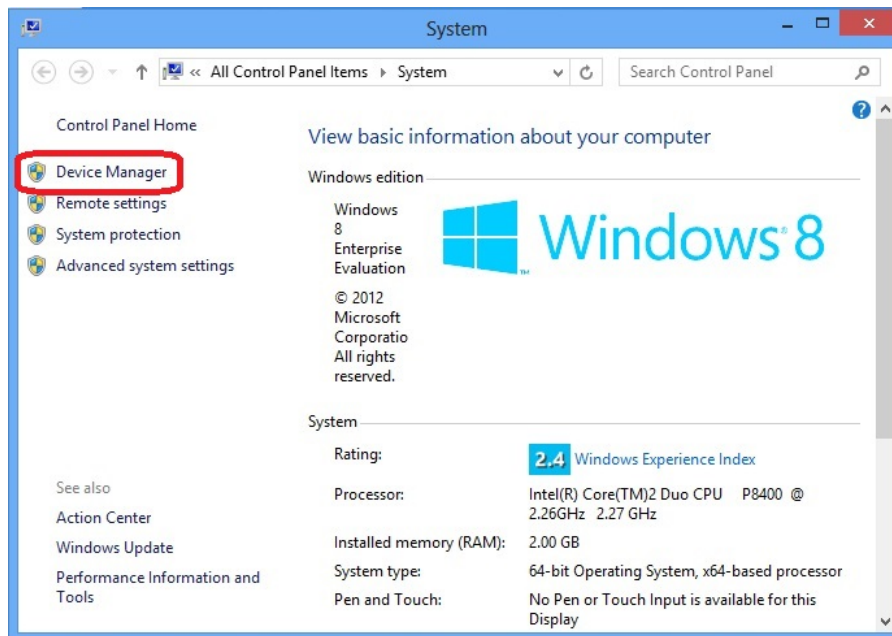

3. Locate the **AirGate-GPRS** (probably with an icon with an exclamation mark next to it) and double-click on it.

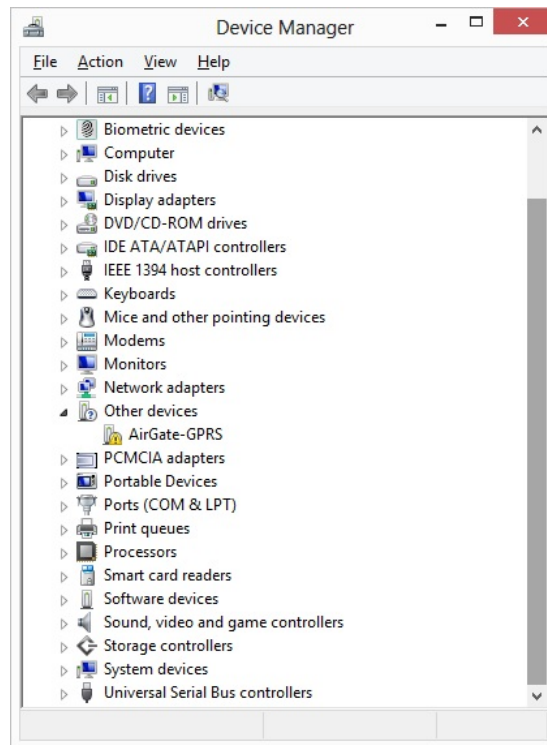

4. Click on the button "Update Driver...".

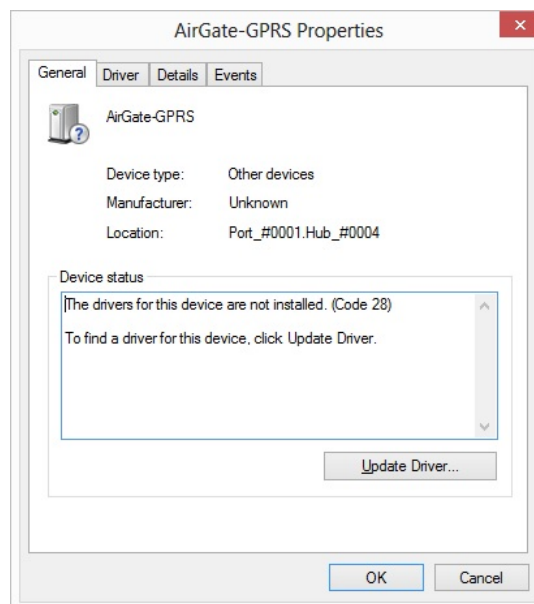

5. Ask to "Browse my computer for driver software".

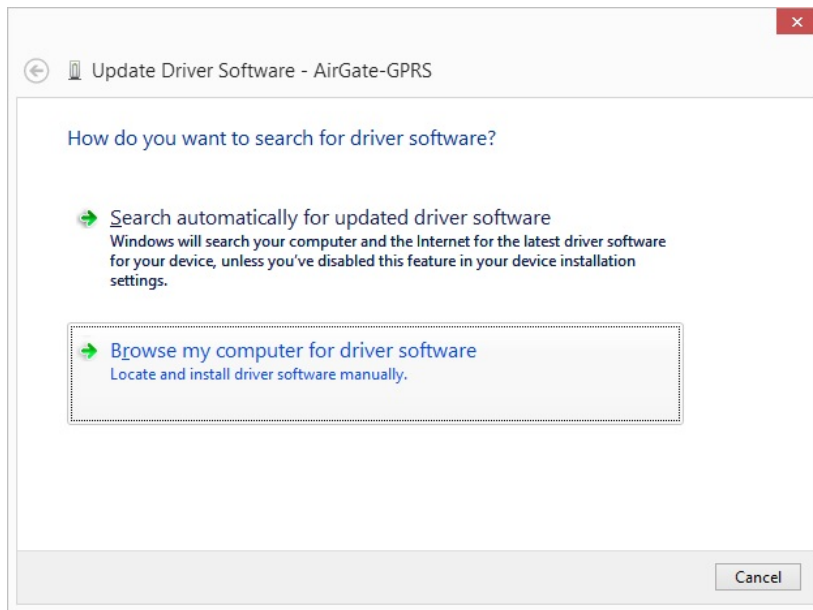

6. Enter the path of the folder where the drivers are located (the product CD or folder where you saved them when downloaded from the site.)

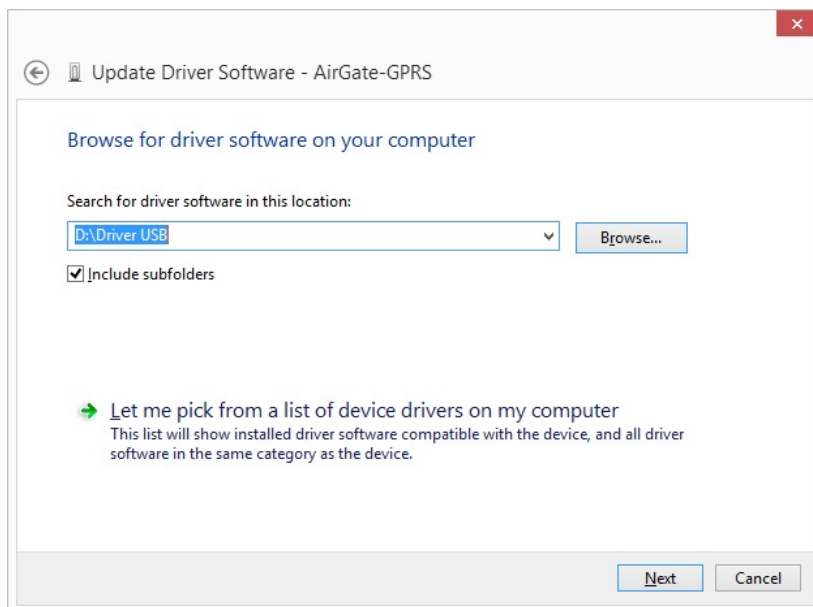

7. Wait for the installation to take start.

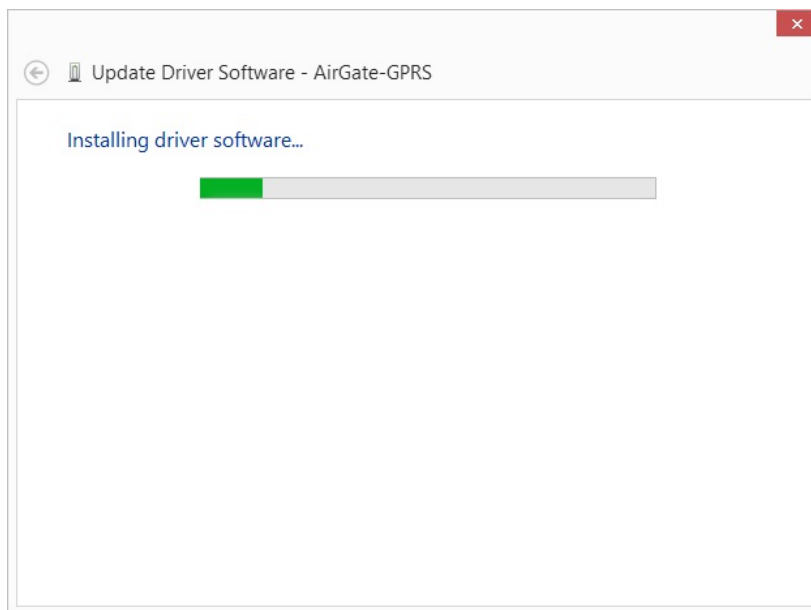

8. Windows will indicate that it cannot verify the editor of this driver. Confirm to install anyway!

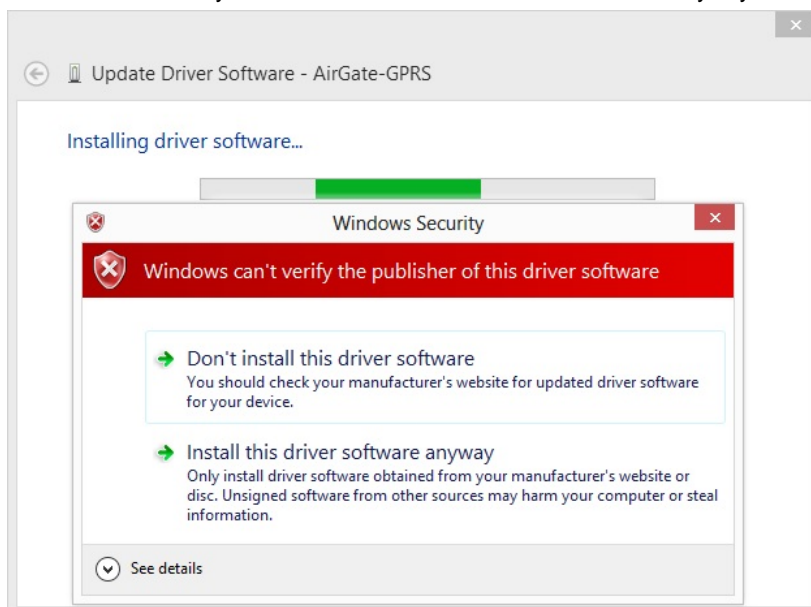

9. A message indicating successful installation will display.

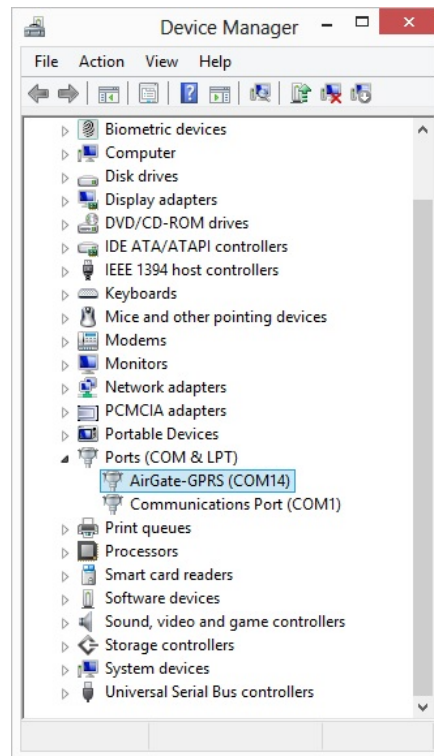

10. Returning to the Device Manager screen, you can check which virtual serial port is allocated to the **AirGate-GPRS**.

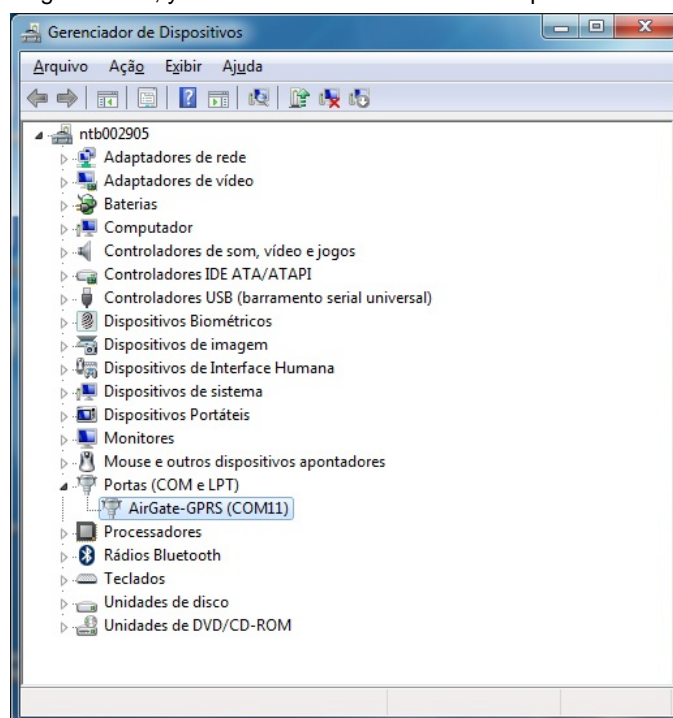

DEFINITION AND SELECTION OF SERIAL PORT (COM) - WINDOWS

The serial port associated with **AirGate-GPS** is automatically defined by the operating system a few moments after connecting the **AirGate-GPS**. The user can easily identify or change the COM port associated with **AirGate-GPS**:

Control Panel / System / Hardware / Device Manager / COM & LPT Ports

Select the device "USB Serial Port" corresponding to the **AirGate-GPS** and click on "Properties". Select "Port Settings" guide and click on "Advanced". In the "COM Port Number", select the serial port to be associated with **AirGate-GPS**. Some serial ports can be checked while being used (In Use). Just select one of these ports if you know that it is not being used by another peripheral device on your computer.

In some cases, the serial ports can be checked as in use even when the associated device is no longer installed on your computer. In this case it is safe to associate this port to **AirGate-GPS**. The following figure presents the view of the device manager containing a **AirGate-GPS**, and the screens showing the property screens where you can reset the associated COM port.

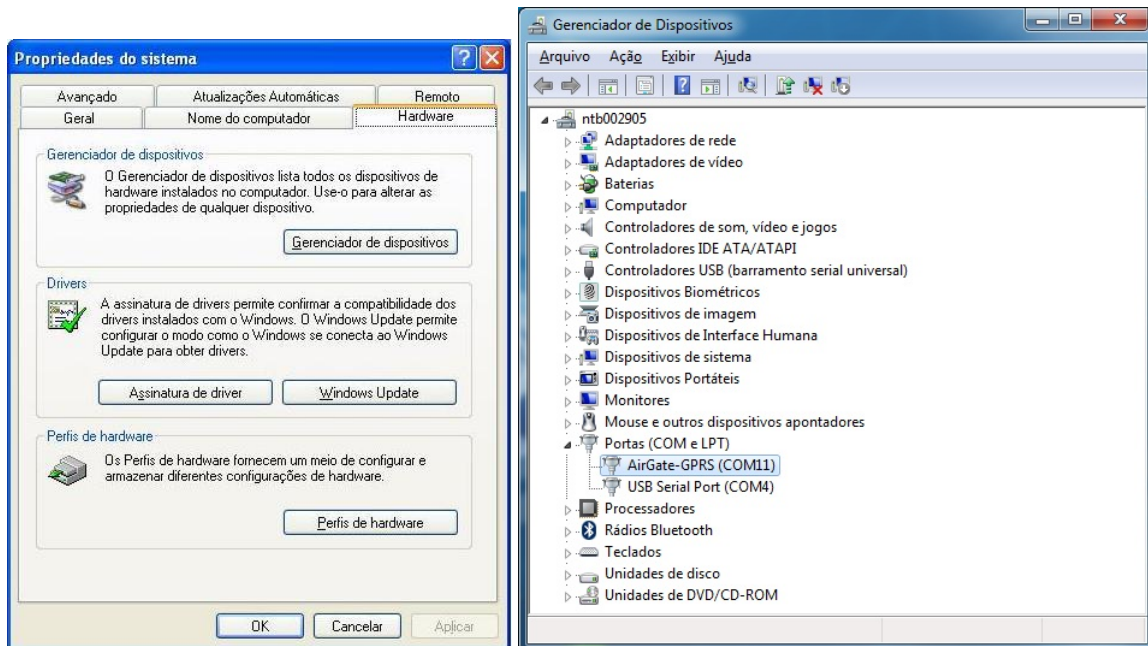

CONFIGURATION SOFTWARE

The software used for configuration of the **AirGate-GPRS** is the **DigiConfig** (version 1.6 or higher). Besides the configuration, it allows the verification of the input channel Reading and provides status information. This software is supplied for free with the product CD and can also be downloaded at the manufacture's website. Checking for updates from time to time is recommended.

DigiConfig has a full help file with all of the necessary information for its complete usage, including the correct configuration of the product configurations. To consult it, start the application and select the "Help" menu, or press the "F1" key.

To begin configuration of the **AirGate-GPRS**, connect it to the computer (via USB or RS485) and select the "Communication" option on the "Configuration" menu. In the window that appears, select the correct serial port and configure the other communication parameters. After applying the communication configuration, the system is ready to read the the **AirGate-GPRS** configuration by clicking on the Search button located in the lower left corner of the main window. In order to make the search faster, configure the Modbus address range to search correctly (do NOT use "Temporary" option for **AirGate-GPRS**). If you know the Modbus address of the interface on which you are connecting (USB or RS485), check only the "First Address" and enter the right address on this field. Once the equipment is identified, it is shown on the list on the left. Clicking on it will display its configuration on the right side.

The configuration of the device is divided by functionality in several tabs. The choice of some options can affect the limitation or absence of other configuration parameters. Last of all, the configuration should be applied to the equipment using the Apply button.

The use of the **AirGate-GPRS** with all of its functionalities is described in the chapter "**AirGate-GPRS** Operation."

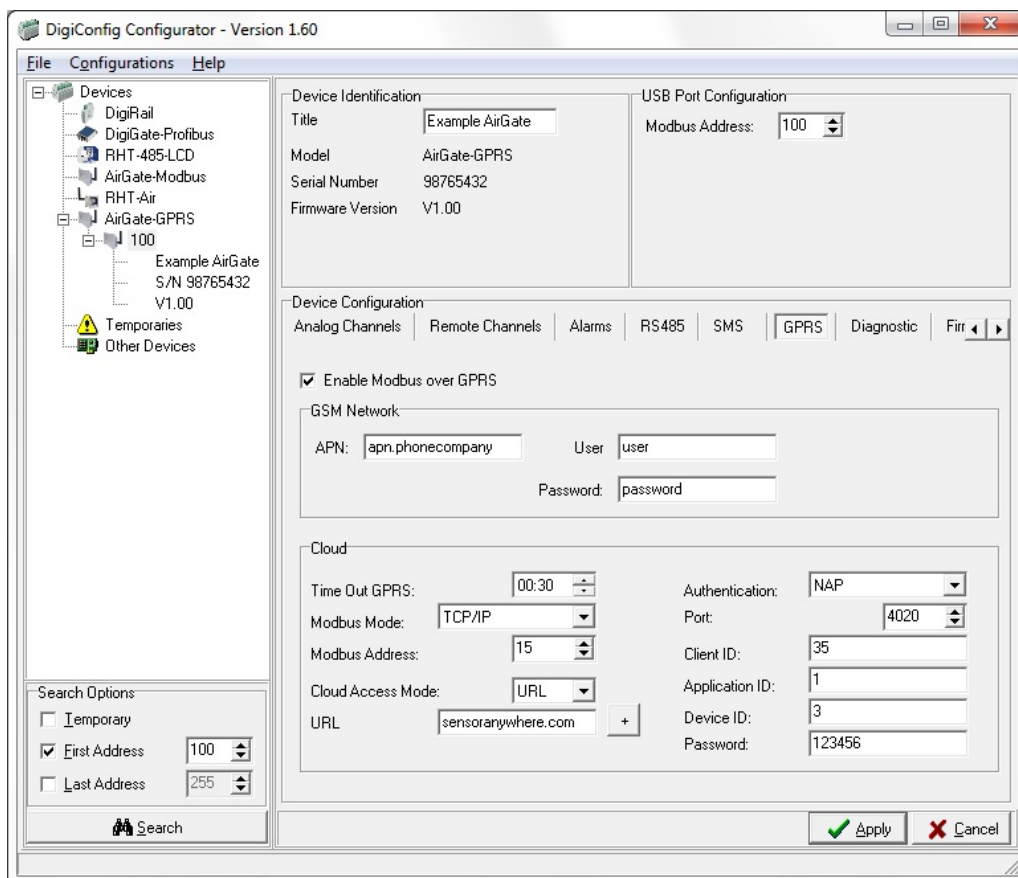

EQUIPMENT SOFTWARE (FIRMWARE) UPDATE

AirGate-GPRS can update its internal software (firmware), allowing the benefits of new versions with new characteristics or important improvements to be accessed without needing to send the equipment to technical assistance.

The latest update is available for download on the manufacturer website. The update process is done by **DigiConfig**, using the related tab.

AIRGATE-GPRS OPERATION

GPRS INTERFACE

The **AirGate-GPRS** allows a RS485/Modbus RTU network to be accessed remotely using the cellular network (GSM – Global System for Mobile Communications). Also, it allows text messages (SMS-Short Message Service) to be sent to notify alarm conditions and to indicate equipment status.

As soon as **AirGate-GPRS** is turned on, as long as there is a SIM Card in the internal connector and the equipment is configured properly, it attempts to connect to a remote (machine-to-machine) server to make their registers and remote consultations available. This connection is made via GPRS in cellular phone networks that use GSM technology.



The use of remote access requires an Internet connectivity service!

NOVUS offers a remote server option. Search the website for the specific service documentation.

If using another connectivity service, see the section “Authorization and Other Details” for the connection details for the configuration and acceptance of **AirGate-GPRS** in the remote server.

Once connected, it waits the receipt of Modbus commands using the remote server. Upon receiving these commands, it checks the need to forward them to possible slaves of the RS485/Modbus RTU network that are connected to it and sends the received answer from the slave back to the server.

AirGate-GPRS constantly monitors the state of the connection. Once it perceives a disconnect with the cellular network or with the remote server, it immediately attempts to reconnect, in order to always keep the path open for new remote requests and to the sending of SMS messages of alarm or status notification.

The correct configuration of this interface is made up of connection parameters with the cellular network, dependent of the carrier used, and also the connection parameters, authentication and communication with the remote server.

AUTHENTICATION AND OTHER DETAILS

The **AirGate-GPRS** will connect with the IP and the configured gates. If, instead of na IP, a URL was configured to access the remote server, this name will be resolved by the equipment and the connection will be made the same way.

Three levels of authentication may be selected: without authentication, simple authentication, and NAP.

WITHOUT AUTHENTICATION

After the connection, no package is transmitted by the **AirGate-GPRS** except the user application data.

OPEN AUTHENTICATION

After the connection, in a time frame of up to 5 seconds, the **AirGate-GPRS** will send an authentication package with the following format:

String “NOVUS-”.	Serial number of AirGate-GPRS (8 digits) in ASCII.	Character “-”.	Code “0105-” in ASCII.	Firmware version for AirGate-GPRS (4 characters) Example: “1.03”.
------------------	---	----------------	------------------------	--

As an example, **AirGate-GPRS** with a serial number 12546890 and firmware version 1.03 would have an authentication package equal to “NOVUS-12546890-0105-1.03”.

AirGate-GPRS awaits an “OK” response (ASCII) from the server. If this answer does not arrive in one second, the authentication package will be resent.

The “keep alive” packets are packets that are sent approximately every 90 seconds in cases where there is no Modbus traffic on the GPRS interface. These packets are to maintain the connection open to speed up the Modbus communication when necessary.

The “keep alive” is a subset of the authentication package, with only the two first fields. For the previous example, the “keep alive” packet would equal “NOVUS-12546890”.

NAP

NAP is a proprietary authentication protocol of NOVUS. Since it is reinforced by cryptography and with other security features, it is the level of authentication suggested to be used with “Sensor Anywhere”.

ANALOG OR DIGITAL INPUT

AirGate-GPRS has two channels for the reading of analog or digital variables. The type of accepted signals are: 0 to 10 V; 4 to 20 mA and digital. The exactness of these types of signals is described in the Specifications section. The connection of these signals is described in the Connections and Installation section.

These analog inputs use an analog/digital (A/D) high resolution (12 bits) and precision converter. The enabled channels will be read every 100 ms.

Each type of analog signal input has a valid measurement range. However, normally the equipment is able to measure the signals that surpass the limits of this range. The amount it can measure beyond the range depends on the type of input configured and can vary even from equipment to equipment.

The following table lists what to expect in the recommendation of **AirGate-GPRS** according to the signal applied at the input for each type of input that is configured.

TYPE OF INPUT	INPUT SIGNAL CONDITION	INDICATION
Voltage (V): 0 to 10 V	Within the range	Value read in input
	Disconnected signal	Value close to 0 V
	A bit above the upper limit	Value read in input *
	A bit below the lower limit	Value read in input *
	Way above upper limit	Configured error value
	Way below lower limit	Configured error value
Current (mA): 4 to 20 mA	Within the range	Value read in input
	Disconnected signal	Configured error value
	A bit above the upper limit	Value read in input *
	A bit below the lower limit	Value read in input *
	Way above upper limit	Configured error value
	Way below lower limit	Configured error value
Digital	Low voltage or closed contact	Value associated with the "0" logical state
	High voltage or open contact	Value associated with the "1" logical state

(*) **Note:** The reference for the analog channel continues a bit beyond the limits specified for the type of selected input. However, in this condition the preciseness is not guaranteed.

Table 02 – Measurement and indication of input by **AirGate-GPRS**

For each channel the digital filter used in the Reading should be chosen, with valid values between "0" (no filter) and "20" (maximum filter): the larger the filter value, the smaller the oscillation read at the input, but the slower the response of the channel to changes in the entry signal.

For each channel, there should be a unique name (tag) given that will be used to reference the channel. The type of input that will be connected to that channel should also be chosen, and the position of the internal jumpers should be modified according to the type of entry. Also, the desired unit of the measured value can be entered.

Also, the input indication range should be chosen, i.e. what the channel should indicate when the input is at its lowest value and what it should indicate when it is at its highest value (highest and lowest values considering the work range of the **AirGate-GPRS** for the type of entry chosen, or for digital input chosen, or for digital inputs, values associated with logic states "0" and "1") Example: Chosen the input type 4 to 20 mA and connected to a pressure transmitter of 0 to 2 bar. In this case, the minimum value chosen for the input configuration should be "0.0" and a maximum value of "2.0". All the resolution and exactness available will be contained in the chosen range.

When some equipment is used in the analog inputs that is connected to the electrical grid (example: voltage simulator), you should use another interface for the reading other than the USB. In some cases, some noise and offsets in the Reading has occurred due to the influence of the USB cable connection, probably due to ground loops.

	Whenever the type of input changes, make sure the internal jumpers are placed in the correct position!
---	--

RS485 INTERFACES

The **AirGate-GPRS** has two RS485 interfaces. One of them always acts as a Modbus master, i.e., several slaves can be connected to it. The second can be configured as a second master (with more connected slaves), as a Modbus slave (to be connected to the RS485 master with a PLC or a computer with a Supervisor) or even disabled.

Both interfaces are completely independent and can be configured with baud rate, parity, or number of stop bits that are different from each other.

	When using both RS485 interfaces as Modbus masters, you may not place slaves with the same address in both buses.
---	---

RS485 - 1

The RS485 interface of the **AirGate-GPRS** is located in terminals 1, 2, and 3 and behaves as a Modbus RTU master, allowing data from other devices on the bus to be read by **AirGate-GPRS** either directly (remote channels) or by other masters using the **AirGate-GPRS** (gateway). Please read the section "Remote Channels" for further details regarding the implementation of a Modbus RTU network with the **AirGate-GPRS** in the role of master.

Modbus commands received by **AirGate-GPRS** where the destination address is the **AirGate** itself will be answered by the **AirGate-GPRS**. All of the Modbus commands received by **AirGate-GPRS** where the destination address is not of the **AirGate-GPRS** itself will be forwarded to the Modbus RTU network, because it is understood that the command is addressed to the slave of this network. More details in the chapter "Data and Routing Communication".

The RS485 - 1 interface can be configured to operate at the following velocities (baud rates): 1200, 2400, 4800, 9600, 19200, 38400, 57600 and 115200. Also, it can be configured to operate with one or two stop bits, and even, odd, or no parities.

Further details regarding the implementation of a network of Modbus devices via RS485 can be found in the document "Basic Concepts of RS485 and RS482" available with the CD that comes with the product.

D1	D	D+	B	Two way data line.	Terminal 1
D0	D	D-	A	Inverted two way data line.	Terminal 2
C			GND	Optional connection that improves the communication performance.	Terminal 3

RS485 - 2

Interface RS485-2 of **AirGate-GPRS** is located in terminals 4, 5, and 6 and can be enabled or disabled. When disabled, it offers no consistency regarding the traffic that may exist on the data bus. When enabled, it can be configured to operate as a Modbus RTU slave or a master.

Slave

When operating as a Modbus RTU slave, the equipment provides the values of the channels to be accessed by the Modbus network master, either a CLP, a type of supervisory software, or some other device. Also, it allows for the accessing of slaves that are connected to RS485-1 using the routing (see chapter "Data Communication and Routing").

Master

When operating as a Modbus RTU master, it allows data from other devices on the bus be read by **AirGate-GPRS** and used by it in the records, alarms, the virtual channels, or simply available from another interface (such as Ethernet). Please see the section "Remote Channels" for more details as to how to implement a Modbus RTU network with **AirGate-GPRS** in the role of master.

Modbus commands received by **AirGate-GPRS**, with a destination address from the **AirGate** itself, will be answered by the **AirGate-GPRS**. All of the Modbus commands received by **AirGate-GPRS** with a destination address other than the AirGate will be forwarded to the Modbus RT network, because it is understood that the command is addressed to a slave of that network. More details are available in the section "Data Communication and Routing".

The RS485-2 interface can be configured to operate at the following speeds (baud rates): 1200, 2400, 4800, 9600, 19200, 38400, 57600 and 115200. Also, it can be configured to operate with one or two stop bits, and even, odd, or no parities.

Further details about the implementation of a network of Modbus devices via RS485 can be found in the document "Basic Concepts of RS485 and RS422" available on the CD that comes with the product.

D1	D	D+	B	Bidirectional data line.	Terminal 4
D0	D	D-	A	Bidirectional inverted data line.	Terminal 5
C			GND	Optional connection that improves the communication performance.	Terminal 6

REMOTE CHANNELS

The **AirGate-GPRS** can operate as an autonomous master for a Modbus RTU network (see configuration of interfaces RS485), as can read up to 10 registers of other devices (Modbus slaves) and use these registers in alarms. Each one of these registers read from other slaves are called "remote channels".

The equipment begins the reading of the channels in the order they were created at the time of configuration. This way, it continues reading all the channels, respecting the time between commands, until it has read them all. After the sweeping interval, it restarts the reading of all of the remote channels. If the reading of the channels takes longer that the configured sweeping interval, it immediately restarts the reading of the channels.

If the slave takes longer that the configured response time, it will be considered a communication error. Likewise, response packets with invalid CRCs or time between bytes larger than what is specified by the standard will be considered errors. If there is a communication error in the reading of the remote channel, it tries again until the number of configured attempts has been reached. If the error persists, the configured error value for the channel will be assumed.

The data read in the remote channels are presented in a “raw” format, i.e., no consistency is made in the value read. The number of decimal points can be configured for the remote channel if the value will be considered with or without a signal for the use of the alarms.

USB INTERFACE

The **AirGate-GPRS** has an isolated USB device used for configuration and monitoring. The Windows® operating system will recognize the equipment as a virtual serial gate, which allows it to be used by Supervisory software (SCADA).

To access it, the USB cable provided should be used. On the first access, it will be necessary to install USB drivers on your computer. To do that, check the “USB Driver Installation” section.

The communication in this interface is Modbus RTU. The same commands and the same table of registers are available on this interface (please refer to the chapter “Modbus Commands and Table of Registers”).

SENDING SMS – ALARMS AND STATUS

Up to 8 destinations for text messages (SMS) can be configured to receive equipment information. This information can be alarm notifications of status information (by event or periodical). The information options that can be received by SMS are:

- Power on: message that indicates the device was turned on.
- Analog channel error: Message that indicates an error in reading the analog channel. It can be enabled individually, in other words, there is a message to indicate an error in analog channel 1 (“Error 1”) and another to indicate an error in analog channel 2 (“Error 2”).
- Status: Message sent periodically with information of up to 2 channels selected by the user. The selected channels should be enabled, and can be analog or remote channels. The frequency of the sending can also be configured.
- Connection state: message sent to indicate the state of the connection. A message is sent to notify that you were able to connect to the remote server (“connection” message) and another to state that the connection was lost (“disconnected” message).
- Alarms: Messages sent whenever a configured alarm condition is met. Up to 8 alarms may be configured, each with its own alarm message.



Some cell phones may not recognize some characters configured in the messages.

For the registration of each destination, an identification tag (contact) should be configured, the country code and area code and the phone number. Then, you should select the events and alarms associated with the contacts, i.e., who should receive each message.

It is possible to choose the kind of header you want in your messages. Standard kind shows the product name (AirGate-GPRS) and the serial number of the device. You can customize the header, entering a small text (up to 40 characters) instead.



SMS sending does **not** depend on the GPRS service.

ALARMS

There are 8 available alarms with this equipment. Each one of the alarms requires the selection of a channel, a condition, and a set point (which can be a constant value or another channel). Also, a debounce time for the alarms (the time interval where a new occurrence of the same alarm is not detected) should be configured. When the alarm condition is met (for example: Channel_1 > 45.0 °C), an event is generated that can be associated with the sending of text messages (SMS) to one or more destinations. For each selected channel, its actual value is used in the comparison. With digital channels, the two values associated with logical states will be used. When a channel is in an error state, the configured error value will be used in the alarm. The channel value to be used will always consider the information of the decimal point and the configured signal.

If there is more than one alarm, the **AirGate-GPRS** will send all the active alarms to the configured destinations in the order of the 1st to the last, and the user can notice a small delay in the receipt of the messages between the configured numbers.

The minimum amount of time between the sending of messages regarding the occurrence of the same alarm is configurable in minutes, in order to avoid receiving many messages reporting the occurrence of an alarm with a marginal condition, where the channel is oscillating around the setpoint. Also, an alarm message may not be resent before its condition is no longer met, i.e., it must cease its alarm condition before it can begin again.

The available conditions are:

- Greater (>): Alarm condition met when the selected channel is greater than the setpoint or than another configured channel.
- Lesser (<): Alarm condition met when the selected channel is less than the setpoint or than another configured channel.

The alarm condition should remain at least 100 ms to ensure it is detected. Also, it is important to remember that the analog channels may have a delay in measuring the real input value, depending on the interval between readings and configured filter, among others. The remote channels however, depend directly of the configured sweeping interval. Thus, these specific types of channels can offer an additional latency in detecting the alarm condition.

Upon starting the device, there is no reliable information on the channels. With the analog channels and the remote channels, you should wait for the first sweep to be completed so the channel values will be available. Therefore, the alarms that use these types of channels can take some time until they can make the comparison with the configured set point. In the specific case of the remote channels, depending on the configuration used, a full sweep of all of the channels can take several seconds.

SMS EXAMPLES

These are some examples of messages (SMS) received by a cell phone. On these examples, the serial number 13028555 **AirGate-GPRS** was configured with the name (title) "Remote-03".

```
AirGate-GPRS (S/N
13028555, TAG
Remote-03)
Power-on message:
firmware version = 0.97
GPRS module version =
3.25
14h40, 2 mai
```

"Power On" message

```
AirGate-GPRS (S/N
13028555, TAG
Remote-03) is connected.
14h40, 2 mai
```

"Connection" message

```
AirGate-GPRS (S/N
13028555, TAG
Remote-03):
Pressure = 00005 bar;
signal level = -63 dBm.
14h40, 2 mai
```

"Status" message

```
AirGate-GPRS (S/N
13028555, TAG
Remote-03) ALARM:
Pressure < 1 bar
Pressure too low!
14h41, 2 mai
```

"Alarm" message

```
AirGate-GPRS (S/N
13028555, TAG
Remote-03) Analog Input 2
is on error!
14h40, 2 mai
```

"Channel Error" message

DATA COMMUNICATION AND ROUTING

The **AirGate-GPRS** has several communication interfaces. Among them, we can highlight some that can be used as Modbus slaves:

- RS485, acting as a slave in the Modbus RTU protocol.

- USB device, acting as a slave in the Modbus RTU protocol.
- GPRS, acting as a server (slave) with the Modbus TCP protocols or the Modbus over TCP (configurable).

All of the equipment configuration, as well as the reading of the input data, is done via Modbus protocol.

In the chapter “Modbus Commands and Tables of Registers” you can find the necessary information to do the reading to the data of the input channels without using the Configuration software. To ensure the correct configuration and the data collection of **AirGate-GPRS**, always use the recommended software. After configuring the equipment, the data of the inputs or the slaves connected to it can be accessed by any other software with the Modbus communication capacity.

ROUTING

The **AirGate-GPRS** has the capacity to rotate commands between its interfaces. Upon receiving a Modbus command from any of its interfaces (USB, GPRS or RS485 slave), it checks if the address of the destination is its own address. If it is, it processes the command and responds to the master itself. If it is not, it assumes that the command is destined for another slave that is connected to some of its RS485 interfaces and forwards the command to it.



All of the Modbus broadcast commands will be routed to the RS485 interfaces. In other words, the **AirGate-GPRS** does not accept broadcast commands sent to it self.

ONE RS485 MASTER INTERFACE

If we use only the RS485 – 1 interface configured and a Modbus master, all of the commands coming from different slave interfaces (USB, GPRS, and/or RS485 - 2) that are not destined for the **AirGate-GPRS** will be routed to this interface.

If you receive Modbus requests from different interfaces at the same time, it will route the first to be received to the RS485 - 1 slave, making the others wait. As soon as it receives an answer from the slave, it will be routed back to the requesting interface (master) and the next in line will be sent to RS485 -1.

TWO RS485 MASTER INTERFACES

If we have the two RS485 interfaces configured with the Modbus master, all of the commands coming from the different slave interfaces (USB and/or GPRS) that are not sent to the **AirGate-GPRS** will be routed to these interfaces.

The first time you receive a command sent to a specific slave (other than itself), it will send this command to both RS485 interfaces, because it still does not know in which the destination slave is located. Upon receiving an answer from the slave, the **AirGate-GPRS** “learns” where it is. Upon receiving the next command for this slave, it will forward the command only to that RS485 interface, reducing the traffic on the other bus.

If Modbus requests are received from several interfaces at the same time, it will route the first to be received by the RS485 -1 slave, leaving the others waiting. As soon as it receives an answer from the slave, it will be routed back to the requesting interface (the master) and the next in line will be forwarded to RS485 – 1.

MODBUS COMMANDS AND REGISTERS TABLE

The **AirGate-GPRS** accepts some Modbus commands that are sent to its Modbus' own address, operating as a network slave. Commands forwarded to other slaves (routing) will be sent in a transparent way. The following listed Modbus RTU commands (functions) are implemented, and these are interpreted by **AirGate-GPRS**. For further information about each command and the Modbus protocol in general, access the website www.modbus.org.

SUPPORTED MODBUS COMMANDS

READ HOLDING REGISTERS – 03H

This command can be used to read a value of one or up to the maximum consecutive holding registers, as shown in the "Table of Holding Registers".

WRITE SINGLE REGISTER – 06H

This command can be used to write on a holding register, as shown in the "Table of Holding Registers".

WRITE MULTIPLE REGISTERS – 16H

This command can be used to write in multiple holding registers, as shown in the "Table of Holding Registers".

TABLE OF HOLDING REGISTERS

The specified addresses correspond to the low level physical addresses, where zero (0) corresponds to the address PLC 40001. The Minimum and Maximum columns have a range of valid values for each parameter. The R/W column indicates if the parameter is for reading and writing (R/W) or if it is only reading ® The Mnemonic SuperView states what the register mnemonic is for in the SuperView software.

Address	Description	Minimum	Maximum	R/W	Mnemonic SuperView
0	Serial number (word high)	0	65535	R	SerialNumber_H
1	Serial number (word low)	0	65535	R	SerialNumber_L
2	Firmware version	0	999	R	FirmwareVersion
3	Value read by the analog/digital channel 1 (whole 16 bits with signal)	-32768	32767	R	AnDig_Ch1
4	Value read by the analog/digital channel 2 (whole 16 bits with signal)	-32768	32767	R	AnDig_Ch2
5	Value read by remote channel 1 (whole 16 bits with signal)	-32768	32767	R	Remote_01
6	Value read by remote channel 2 (whole 16 bits with signal)	-32768	32767	R	Remote_02
7	Value read by remote channel 3 (whole 16 bits with signal)	-32768	32767	R	Remote_03
8	Value read by remote channel 4 (whole 16 bits with signal)	-32768	32767	R	Remote_04
9	Value read by remote channel 5 (whole 16 bits with signal)	-32768	32767	R	Remote_05
10	Value read by remote channel 6 (whole 16 bits with signal)	-32768	32767	R	Remote_06
11	Value read by remote channel 7 (whole 16 bits with signal)	-32768	32767	R	Remote_07
12	Value read by remote channel 8 (whole 16 bits with signal)	-32768	32767	R	Remote_08
13	Value read by remote channel 9 (whole 16 bits with signal)	-32768	32767	R	Remote_09
14	Value read by remote channel 10 (whole 16 bits with signal)	-32768	32767	R	Remote_10
15	State of GSM connection (0=disconnected; 1 = connected; 2=connected and authenticated)	0	2	R	GSM_Status
31	SIM Card Identification – characters 1 and 2	-32768	32767	R	-
32	SIM Card Identification – characters 3 and 4	-32768	32767	R	-
33	SIM Card Identification – characters 5 and 6	-32768	32767	R	-
34	SIM Card Identification – characters 7 and 8	-32768	32767	R	-
35	SIM Card Identification – characters 9 and 10	-32768	32767	R	-
36	SIM Card Identification – characters 11 and 12	-32768	32767	R	-
37	SIM Card Identification – characters 13 and 14	-32768	32767	R	-
38	SIM Card Identification – characters 15 and 16	-32768	32767	R	-
39	SIM Card Identification – characters 17 and 18	-32768	32767	R	-
40	SIM Card Identification – characters 19 and 20	-32768	32767	R	-
41	SIM Card Identification – characters 21 and 22	-32768	32767	R	-
42	SIM Card Identification – characters 23 and 24	-32768	32767	R	-
43	SIM Card Identification – characters 25 and 26	-32768	32767	R	-
44	SIM Card Identification – characters 27 and 28	-32768	32767	R	-
45	SIM Card Identification – characters 29 and 30	-32768	32767	R	-

Address	Description	Minimum	Maximum	R/W	Mnemonic SuperView
46	Current level of GSM signal, in dBm	-999	0	R	SignalLevel
51	Status 1	-32768	32767	R	Status1
52	Status 2	-32768	32767	R	Status2

DETAILS ABOUT SOME REGISTERS

REGISTERS 0 AND 1 - SERIAL NUMBER

Device serial number. Both registers together make up the serial number of the equipment, i.e., it should be treated as a 32-bit number.

REGISTER 2 – FIRMWARE VERSION

States the version of firmware of the device, as shown below:

If the version is "1.00" it will read the value as "100". If the version is "2,04" it will read it as "204".

REGISTERS 3 AND 4 – VALUE OF THE ANALOG/DIGITAL CHANNEL

States the value of the respective input channel, according to the configuration. The value will be multiplied by a factor of 10, depending on the number of configured decimal points. Example: Value of 31.78 will be read as 3178.

REGISTERS 5 TO 14 – VALUE OF REMOTE CHANNEL

States the value of the respective remote channel, as show in the configuration. The value will be multiplied by a factor of 10, depending on the number of configured decimal points. Example: Value of 31.78 will be read as 3178.

REGISTERS 31 TO 45 – SIM CARD IDENTIFICATION

Code IMSI inscribed on the SIM card connected to the *AirGate-GPRS* (in ASCII).

REGISTER 46 – GSM SIGNAL LEVEL

Indicates the current level of GSM signal intensity in dBm.

REGISTER 51 – STATUS 1

Indicates the state of the alarms and errors in the analog/digital input channels.

Bit	Function
0	Alarm state 1 (1 = in alarm)
1	Alarm state 2 (1 = in alarm)
2	Alarm state 3 (1 = in alarm)
3	Alarm state 4 (1 = in alarm)
4	Alarm state 5 (1 = in alarm)
5	Alarm state 6 (1 = in alarm)
6	Alarm state 7 (1 = in alarm)
7	Alarm state 8 (1 = in alarm)
8	Error in input channel 1 (1 = in error)
9	Error in input channel 2 (1 = in error)

REGISTER 52 – STATUS 2

Indicates errors in remote channels, i.e., indicates that the requested slave did not respond to the Modbus command.

Bit	Function
0	Error in remote channel 1 (1 = in error)
1	Error in remote channel 2 (1 = in error)
2	Error in remote channel 3 (1 = in error)
3	Error in remote channel 4 (1 = in error)
4	Error in remote channel 5 (1 = in error)
5	Error in remote channel 6 (1 = in error)
6	Error in remote channel 7 (1 = in error)
7	Error in remote channel 8 (1 = in error)
8	Error in remote channel 9 (1 = in error)
9	Error in remote channel 10 (1 = in error)

WARRANTY

Warranty conditions are available on our web site: www.novusautomation.com.