



IoT Controller

Featuring LoRaWAN®

UC100

User Guide



Safety Precautions

Milesight will not shoulder responsibility for any loss or damage resulting from not following the instructions of this operating guide.

- ❖ The device must not be remodeled in any way.
- ❖ Do not place the device close to objects with naked flames.
- ❖ Do not place the device where the temperature is below/above the operating range.
- ❖ Power off the device when installing or wiring.
- ❖ Make sure electronic components do not drop out of the enclosure while opening.
- ❖ The device must never be subjected to shocks or impacts.

Declaration of Conformity

UC100 is in conformity with the essential requirements and other relevant provisions of the CE, FCC, and RoHS.

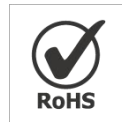

Copyright © 2011-2022 Milesight. All rights reserved.

All information in this guide is protected by copyright law. Whereby, no organization or individual shall copy or reproduce the whole or part of this user guide by any means without written authorization from Xiamen Milesight IoT Co., Ltd.

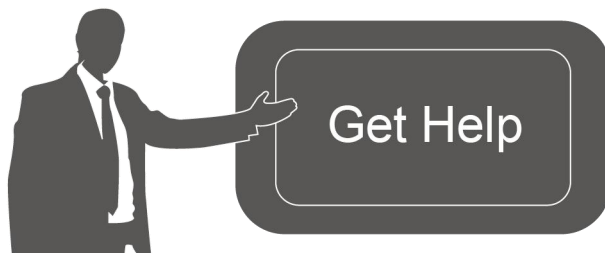

For assistance, please contact

Milesight technical support:

Email: iot.support@milesight.com

Tel: 86-592-5085280

Fax: 86-592-5023065

Address: Building C09, Software Park III,
Xiamen 361024, China

Revision History

Date	Doc Version	Description
May 27, 2022	V 1.0	Initial version

Contents

1. Product Introduction	4
1.1 Overview	4
1.2 Features	4
2. Hardware Introduction	4
2.1 Packing List	4
2.2 Hardware Overview	5
2.3 LED Patterns and Reset Button	5
2.4 Dimensions (mm)	5
3. Device Installation	5
4. Operation Guide	6
4.1 Log in the ToolBox	6
4.2 LoRaWAN Settings	7
4.3 General Settings	10
4.3.1 Basic Settings	10
4.3.2 RS485 Settings	10
4.4 IF-THEN Command	13
4.5 LoRa D2D Settings	14
4.6 Maintenance	17
4.6.1 Upgrade	17
4.6.2 Backup	17
4.6.3 Reset to Factory Default	18
5. Device Payload	18
5.1 Device Information	19
5.2 Sensor Data	19
5.3 Downlink Command	21

1. Product Introduction

1.1 Overview

UC100 is an IoT controller used for remote control and data acquisition from Modbus RS485 devices via LoRaWAN® networks. It can read up to 16 Modbus RTU devices and support Modbus transparent transmission between server and RS485 devices as a Modbus to LoRaWAN® converter. Besides, UC100 supports multiple trigger conditions and actions which can work autonomously even when the network drops.

1.2 Features

- Easy to connect with diverse wired sensors through RS485 interfaces
- Support LoRaWAN® wireless communication
- Multiple triggering conditions and actions
- Embedded watchdog for work stability
- Industrial metal case design with a wide operating temperature range
- Compliant with standard LoRaWAN® gateways and network servers
- Quick and easy management with Milesight IoT Cloud solution

2. Hardware Introduction

2.1 Packing List

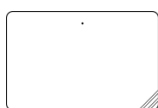

1 × UC100 Device

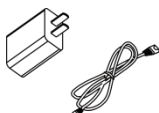

1 × Type-C Cable
& Power Adapter

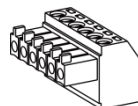

1 × Terminal
Block

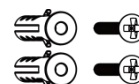

2 × Wall Mounting
Kits



1 × Quick Guide



If any of the above items are missing or damaged, please contact your sales representative.

2.2 Hardware Overview

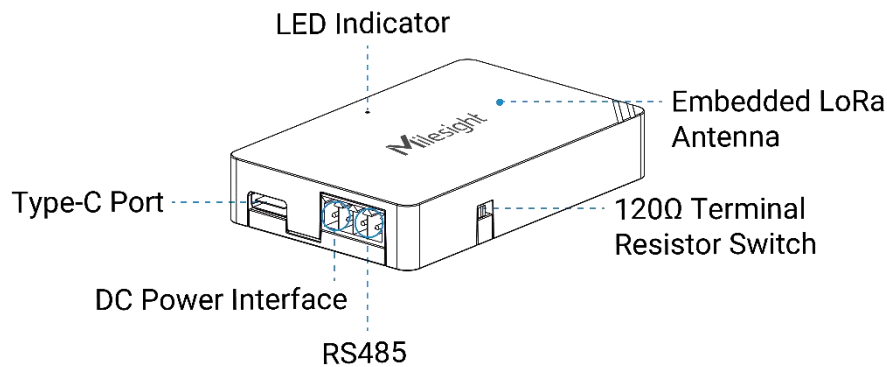

2.3 LED Patterns and Reset Button

The reset button is inside the device.

Device Status	LED Status
System is functioning properly	Static On
Reboot: hold the reset button inside the device for more than 3 seconds	Static On → Slowly Blinks
Reset to factory default: hold the reset button inside the device for more than 10 seconds	Static On → Quickly Blinks
Fail to acquire data from data interfaces	Slowly Blinks
Device upgrade or system error	Static On

2.4 Dimensions (mm)

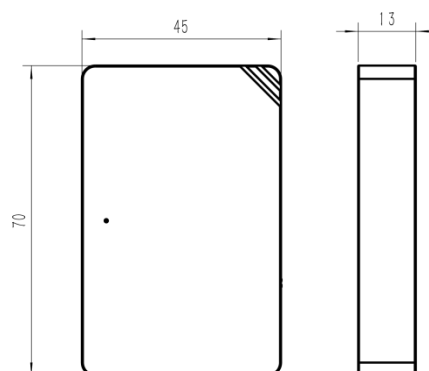

3. Device Installation

UC100 device can be placed on a desktop or mounted to a wall.

1. Take off the back cover of UC100 device, and fix the wall plugs into the wall according to the drilling position as referred.

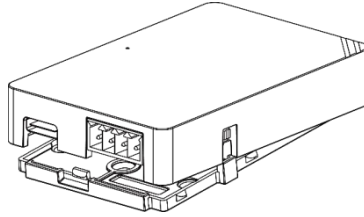

2. Screw the cover on the mounting positions and install back the device.

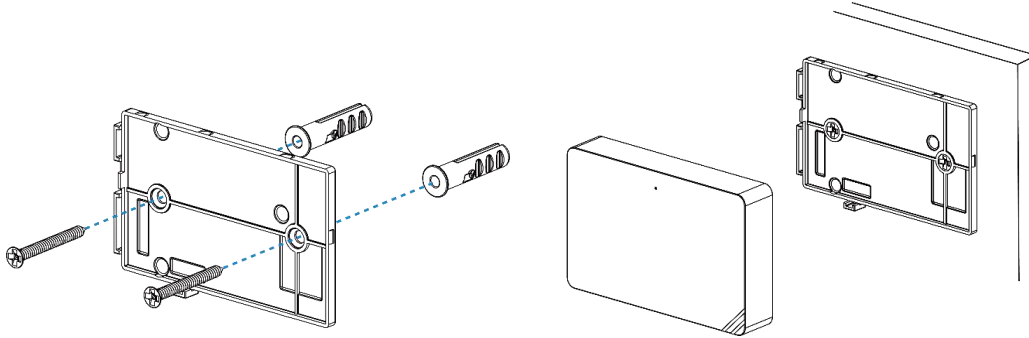

4. Operation Guide

4.1 Log in the ToolBox

1. Download ToolBox software from [Milesight IoT website](#).
2. Power on the UC100 device, then connect it to computer via the type-C port.

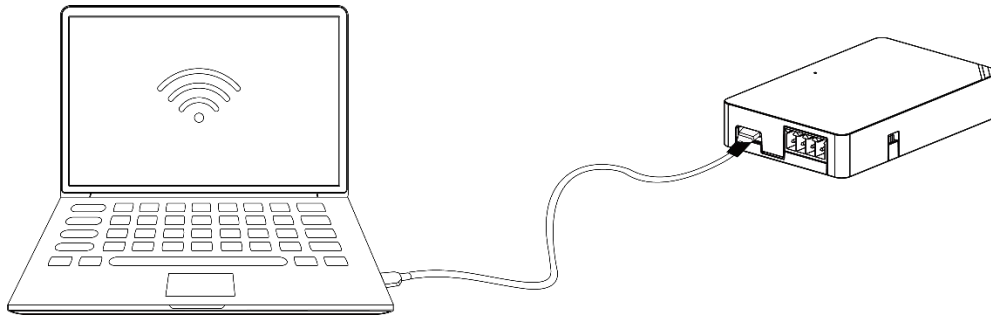

3. Open the ToolBox and select type as "General", then click password to log in ToolBox.
(Default password: **123456**)

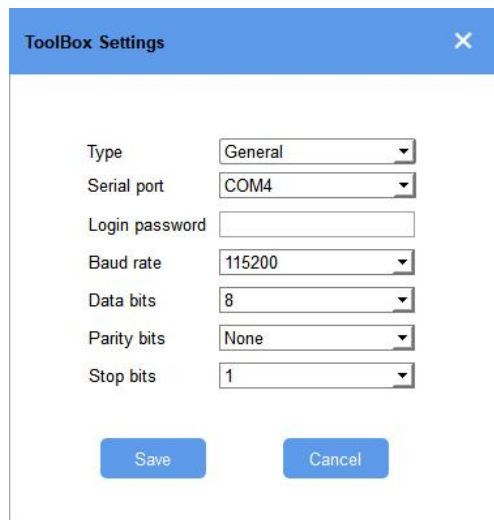

Type	General
Serial port	COM4
Login password	
Baud rate	115200
Data bits	8
Parity bits	None
Stop bits	1

Save Cancel

4. After logging in the ToolBox, you can change device settings.

Status >

Model:	UC100-915M
Serial Number:	6468C15002130004
Device EUI:	24e124468c150021
Firmware Version:	01.01
Hardware Version:	1.0
Join Status:	De-Activate
RSSI/SNR:	0/0
Channel Mask:	#####
Uplink Frame-counter:	0
Downlink Frame-counter:	0

4.2 LoRaWAN Settings

LoRaWAN settings are used for configuring the transmission parameters in LoRaWAN® network.

Basic LoRaWAN Settings:

Go to "LoRaWAN Settings -> Basic" to configure join type, App EUI, App Key and other information. You can also keep all settings by default.

Device EUI	<input type="text" value="24E124445B434113"/>
App EUI	<input type="text" value="24E124C0002A0001"/>
Application Port	<input type="text" value="85"/>
Join Type	<input type="text" value="OTAA"/>
Class Type	<input type="text" value="Class C"/>
Application Key	<input type="text" value="*****"/>
RX2 Date Rate	<input type="text" value="DR0 (SF12, 125 kHz)"/>
RX2 Frequency	<input type="text" value="505300000"/>
Spread Factor	<input type="text" value="SF10-DR2"/>
Confirmed Mode	<input type="checkbox"/>
Rejoin Mode	<input checked="" type="checkbox"/>
Set the number of packets sent	<input type="text" value="32"/> packets
ADR Mode	<input checked="" type="checkbox"/>
TXPower	<input type="text" value="TXPower0-19.15 dBm"/>

Parameters	Description
Device EUI	Unique ID of the device on the label.
App EUI	Default App EUI is 24E124C0002A0001.
Application Port	The port is used for sending and receiving data, the default port is 85.
Working Mode	Fixed as Class C.
Join Type	OTAA and ABP modes are available.
Application Key	Appkey for OTAA mode, default is 5572404C696E6B4C6F52613230313823.
Device Address	DevAddr for ABP mode, default is the 5 th to 12 th digits of SN.
Network Session Key	Nwkskey for ABP mode, default is 5572404C696E6B4C6F52613230313823.
Application Session Key	Appskey for ABP mode, default is 5572404C696E6B4C6F52613230313823.
RX2 Data Rate	RX2 data rate to receive downlinks.
RX2 Frequency	RX2 frequency to receive downlinks. Unit: Hz
Spread Factor	If ADR is disabled, the device will send data via this spread factor.
Confirmed Mode	If the device does not receive ACK packet from network server, it will resend data 3 times at most.

Rejoin Mode	Reporting interval \leq 30 mins: the device will send a specific number of LinkCheckReq MAC packets to the network server every 30 mins to validate connectivity; If there is no response, the device will re-join the network. Reporting interval $>$ 30 mins: the device will send a specific number of LinkCheckReq MAC packets to the network server every reporting interval to validate connectivity; If there is no response, the device will re-join the network.
Set the number of packets sent	When rejoin mode is enabled, set the number of LinkCheckReq packets sent.
ADR Mode	Allow the network server to adjust datarate of the device.
Tx Power	Transmit power of device.

Note:

- 1) Please contact sales for device EUI list if there are many units.
- 2) Please contact sales if you need random App keys before purchasing.
- 3) Select OTAA mode if you use Milesight IoT Cloud to manage devices.
- 4) Only OTAA mode supports rejoin mode.

LoRaWAN Frequency Settings:

Go to “**LoRaWAN Settings -> Channel**” to select supported frequency and select channels to send uplinks. Make sure the channels match what you set in the LoRaWAN® gateway.

<input type="checkbox"/>	Index	Frequency/MHz	Max Datarate	Min Datarate
<input checked="" type="checkbox"/>	0	868.1	5-SF7BW125	0-SF12BW125
<input checked="" type="checkbox"/>	1	868.3	5-SF7BW125	0-SF12BW125
<input checked="" type="checkbox"/>	2	868.5	5-SF7BW125	0-SF12BW125
<input type="checkbox"/>	3	0	5-SF7BW125	0-SF12BW125
<input type="checkbox"/>	4	0	5-SF7BW125	0-SF12BW125
<input type="checkbox"/>	5	0	5-SF7BW125	0-SF12BW125
<input type="checkbox"/>	6	0	5-SF7BW125	0-SF12BW125

If frequency is one of CN470/AU915/US915, you can enter the index of the channel that you want to enable in the input box, making them separated by commas.

Examples:

1, 40: Enabling Channel 1 and Channel 40

1-40: Enabling Channel 1 to Channel 40

1-40, 60: Enabling Channel 1 to Channel 40 and Channel 60

All: Enabling all channels

Null: Indicates that all channels are disabled

Support Frequency : AU915

Enabled Channel Index: 0-71

Channel Index	Frequency/MHz	Channel Spacing/MHz	BW/kHz
0 - 15	915.2 - 918.2	0.2	125
16 - 31	918.4 - 921.4	0.2	125
32 - 47	921.6 - 924.6	0.2	125
48 - 63	924.8 - 927.8	0.2	125
64 - 71	915.9 - 927.1	1.6	500

4.3 General Settings

4.3.1 Basic Settings

Device ID	<input style="width: 100%;" type="text" value="6445C06166800001"/>
Reporting Interval(min)	<input style="width: 100%;" type="text" value="20"/>
LoRa D2D	<input type="checkbox"/>
D2D Key	<input style="width: 100%;" type="text" value="*****"/>
Change Password	<input type="checkbox"/>

Parameters	Description
Device ID	Show the SN of the device.
Reporting Interval	Reporting interval of transmitting data to the network server. Range: 1-1080 mins, default: 20 mins
LoRa D2D	See details on chapter 4.5 .
Change Password	Change the password to log in ToolBox.

4.3.2 RS485 Settings

UC100 has one RS485 port for Modbus RTU device connection.

1. Connect RS485 device to RS485 port.
2. Go to **General -> RS485** to enable RS485 and configure serial port settings. Serial port settings should be the **same** as the RS485 terminal devices.

Basic
RS485

Stop Bit	<input style="width: 100%;" type="text" value="1 bits"/>
Data Bit	<input style="width: 100%;" type="text" value="8 bits"/>
Parity	<input style="width: 100%;" type="text" value="None"/>
Baud Rate	<input style="width: 100%;" type="text" value="9600"/>
Execution Interval (ms)	<input style="width: 100%;" type="text" value="50"/>
Max Resp Time (ms)	<input style="width: 100%;" type="text" value="500"/>
Max Retry Times	<input style="width: 100%;" type="text" value="3"/>
Modbus RS485 bridge LoRaWAN	<input checked="" type="checkbox"/> ?
Port	<input style="width: 100%;" type="text" value="0"/> ?

Parameters	Description
Stop Bit	1 bit/2 bit are available.
Data Bit	8 bit is available.
Parity	None, Odd and Even are available.
Baud Rate	1200/2400/4800/9600/19200/38400/57600/115200 are available.
Execution Interval (ms)	The execution interval between each Modbus channel command.
Max Resp Time (ms)	The maximum response time that the UC100 waits for the reply to the command. If it does not get a response after the max response time, it is determined that the command has timed out.
Max Retry Time (ms)	Set the maximum retry times after the device fails to read data from RS485 terminal devices.
Modbus RS485 bridge LoRaWAN	If this mode is enabled, the device will transmit Modbus RTU commands from the network server to RS485 terminal devices transparently and send Modbus reply originally back to the network server.

Port: Select from 2-84, 86-223.

3. Click  to add Modbus channels, then save configurations.

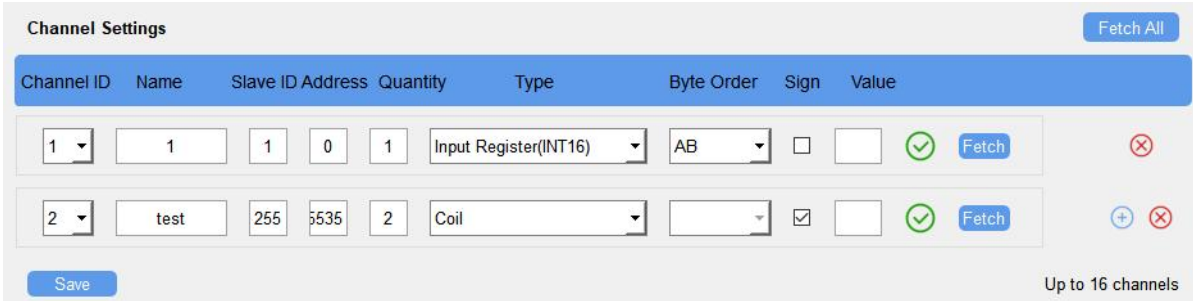

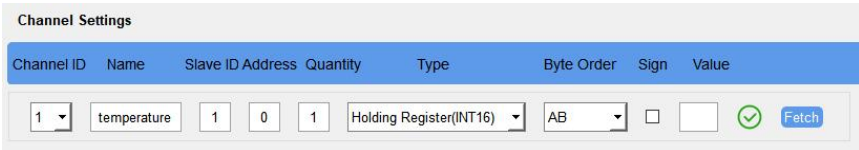
Parameters	Description
Channel ID	Select the channel ID you want to configure from 16 channels.
Name	Customize the name to identify every Modbus channel.
Slave ID	Set Modbus slave ID of a terminal device.
Address	The starting address for reading.
Quantity	Set read how many digits from starting address, it fixes to 1.
Type	Select the data type of Modbus channels.
Byte Order	Set the Modbus data reading order if you configure the type as Input register or holding register. INT32/Float: ABCD, CDBA, BADC, DCBA INT16: AB, BA
Sign	The tick indicates that the value has a plus or minus sign.
Fetch	After clicking, UC100 will send Modbus read command to test if it can read correct values. Example: as this setting, the device will send command: 01 03 00 00 00 01 84 0A 

4. Click "Fetch" to check if UC100 can read correct data from terminal devices.



Note: Do not click "Fetch" frequently since the response time to reply is differ for every terminal device.

4.4 IF-THEN Command

UC100 supports configuring locally IF-THEN commands to do some actions automatically even without a network connection. One device can be added 16 commands at most.

1. Go to "Command" page, and click "Edit" to add commands.

Settings > Reboot

Save

ID	Configuration	Edit	Delete
1	If received a d2d control command containing 1234 . then send a modbus command via the rs485 interface and content is 1234 .		
2			
3			
4			
5			

2. Set an IF condition based on the terminal device data or UC100 device status.

Configuration for command NO.1

If Channel ▼

Alarm(2) ▼ False ▼

Is continued for 0 s ▼

Set lockout time ?

Condition	Description
Channel	When UC100 device gets certain response (False, True, Above, Below, Within) in certain RS485 channel (Channel Name + Channel ID), this command is triggered. Is continued for: the updated value should last for some time that is longer

	<p>than a sole reporting interval.</p> <p>Set lockout time: after the lockout time, UC100 will check if the latest RS485 response matches the condition still. 0 means this IF condition will only be detected once.</p>
Received a D2D control command	This only works with the LoRa D2D feature enabled. See details on chapter 4.5 .

3. Set THEN action according to your request. You can add at most 3 actions in one command.

Then +

Content is

Action	Description
Send a LoRaWAN message	Send a custom message to the network server.
Restart the Device	Reboot the device.
Send a D2D control command	This only works with LoRa D2D feature enabled. See details on chapter 4.5 .
Send a Modbus command via the RS485 interface	This only works with LoRa D2D feature enabled. See details on chapter 4.5 .

4.5 LoRa D2D Settings

LoRa D2D protocol is developed by Milesight and used for setting up transmission among Milesight devices without a gateway. When the LoRa D2D setting is enabled, UC100 can work as a LoRa D2D controller to send control commands to other devices or work as a LoRa D2D agent to receive commands to trigger a reboot or message to the network server.

1. Go to **"General -> Basic"** page, enable LoRa D2D feature, and define a unique LoRa D2D key which is the same as LoRa D2D controller or agent devices. (Default LoRa D2D Key: 5572404C696E6B4C6F52613230313823)

Device ID	6468C15002130004
Reporting Interval(min)	20
LoRa D2D	<input checked="" type="checkbox"/>
D2D Key	*****
Change Password	<input type="checkbox"/>

Save

2. Go to “LoRaWAN Settings -> Basic” to configure the RX2 datarate and RX2 frequency. When UC100 works as LoRa D2D controller, it will send commands as RX2 settings.

LoRaWAN >

App EUI	24E124C0002A0001
Application Port	85
Join Type	OTAA
Class Type	Class C
Application Key	*****
RX2 Date Rate	DR0 (SF12, 125 kHz)
RX2 Frequency	505300000
Spread Factor	SF10-DR2
Confirmed Mode	<input type="checkbox"/>

3. Go to “Command” page to set corresponding operations.

When the RS485 channel triggers, UC100 can work as LoRa D2D controller to send a control command to control the LoRa D2D agent device. The command should be a 2-byte hexadecimal number.

Configuration for command NO.1

If Channel

Alarm(2) False

Is continued for 0 s

Set lockout time ?

Then Send a D2D control command +

Content is 0001

When UC100 receives a LoRa D2D command, it can work as a LoRa D2D agent to reboot the device or send Modbus command to RS485 terminal devices.

Configuration for command NO.1

If Received a D2D control command

Containing 0002

Then Send a Modbus command via the RS485 interfa +

Content is 010300000001840A

4.6 Maintenance

4.6.1 Upgrade

UC100 supports upgrade firmware locally via ToolBox software.

1. Download firmware from www.milesight-iot.com to your PC.
2. Go to **"Maintenance -> Upgrade"**, click **"Browse"** to import firmware and upgrade the device.

You can also click **"Up to Date"** to search for the latest firmware of the device and upgrade.

Note: Any operation on ToolBox is not allowed during upgrading, otherwise the upgrading will be interrupted, or even the device will break down.

Maintenance >

Upgrade		Backup and Reset
Model:	UC100-915M	
Firmware Version:	01.01	
Hardware Version:	1.0	
Domain:	Beijing Server	
FOTA:	Up to date	
Local Upgrade	<input type="text"/>	Browse Upgrade

4.6.2 Backup

UC100 devices support configuration backup for easy and quick device configuration in bulk.

Backup is allowed only for devices with the same model and LoRa frequency band.

1. Go to **"Maintenance -> Backup and Reset"**, and click **"Export"** to save the current configuration as json format backup file.
2. Click **"Browse"** to select the backup file, then click **"Import"** to import the configurations.

The screenshot shows the 'Backup and Reset' section of the Milesight IoT web interface. It features three main rows of controls:

- Config Backup:** A blue button labeled 'Export'.
- Config File:** A text input field, a blue 'Browse' button, and a blue 'Import' button.
- Restore Factory Defaults:** A blue button labeled 'Reset'.

4.6.3 Reset to Factory Default

Please select one of following methods to reset device:

Via Hardware: Open the case of UC100, and hold the reset button for more than 10s until the LED blinks.

Via Toolbox Software: Go to **"Maintenance -> Backup and Reset"** to click "Reset".

This screenshot is identical to the one above, showing the 'Backup and Reset' section of the Milesight IoT web interface with the same three rows of controls.

5. Device Payload

All data are based on the following format (HEX):

Channel1	Type1	Data1	Channel2	Type2	Data2	Channel 3	...
1 Byte	1 Byte	N Bytes	1 Byte	1 Byte	M Bytes	1 Byte	...

Among them, Data field are shown as little endian. For decoder examples, you can find them at <https://github.com/Milesight-IoT/SensorDecoders>.

5.1 Device Information

UC100 reports basic device information of device every time joining the network.

Channel	Type	Data Size/Byte	Description
ff	01 (Protocol Version)	1	01 => V1
	09 (Hardware Version)	2	01 20 => V1.2
	0a (Software Version)	2	01 01 => V1.1
	0b (Power event)	1	ff => powered on
	16 (Device SN)	8	64 45 B4 34 11 30 00 01 => SN is 64 45 B4 34 11 30 00 01

Example:

ff0bff ff0101 ff166445b43411300001 ff090100 ff0a0101		
Channel	Type	Value
ff	0b (Power Event)	ff (powered on)
ff	01 (Protocol Version)	01 (V1)
ff	16 (Device SN)	64 45 B4 34 11 30 00 01
ff	09 (Hardware Version)	0100 (V1.0)
ff	0a (Software Version)	0101 (V1.1)

5.2 Sensor Data

UC100 reports RS485 sensor data according to reporting interval (20 mins by default).

Channel	Type	Byte	Description	
ff	19 (RS485)	Mutable (4-7)	Total: Byte 1+Byte 2+Byte 3+Value Byte 1: Channel ID Byte 2: Data Size Byte 3: Data Type	
			Code	Data Type
			00	Coil
			01	Discrete
			02	Input16
			03	Hold16
			04	Hold32
			05	Hold_float
			06	Input32
			07	Input_float
08	Input_int32_with upper			

				16 bits
			09	Input_int32_with lower 16 bits
			0a	Hold_int32_with upper 16 bits
			0b	Hold_int32_with lower 16 bits
ff	15 (Modbus collecting exception)	1	Channel ID of failed Modbus collection.	

Note: Channel ID can be configured in ToolBox.

Channel ID	Description
00	RS485 (Modbus Master) Channel 1
01	RS485 (Modbus Master) Channel 2
02	RS485 (Modbus Master) Channel 3
...	...
0f	RS485 (Modbus Master) Channel 16

Examples:

ff 19 07 02 03 15 00					
Channel	Type	Channel ID	Data Size	Data Type	Value
ff	19 (RS485)	07 => Channel 8	02 => 2 bytes	03 => Hold 16	15 00 => 00 15 = 21

Note: When data type is holding register or input register, ToolBox can set different byte orders. Take below Modbus register response from RS485 sensors as example:

Register Address	Value (Hex)
0	00 15
1	00 20

When using different byte orders, you can use ToolBox to fetch different results, and the device will upload data with little endian order.

Data Type	Byte Order	Fetch Result	Uplink (HEX)
Holding/Input Register (INT16)	AB	21 (0x15)	15 00 (BA)
	BA	5376 (0x1500)	00 15 (AB)
Holding/Input Register (INT32)	ABCD	1376288 (0x00150020)	20 00 15 00 (DCBA)
	CDAB	2097173 (0x00200015)	15 00 20 00 (BADC)
	BADC	352329728 (0x15002000)	00 20 00 15 (CDAB)

	DCBA	536876288 (0x20001500)	00 15 00 20 (ABCD)
Holding/Input Register (INT32 with upper 16 bits)	/	21 (0x15)	15 00 00 00
Holding/Input Register (INT32 with lower 16 bits)	/	32 (0x20)	20 00 00 00

If UC100 fails to connect the Modbus data, it will send an error message.

Channel ID	Name	Slave ID	Address	Quantity	Type	Byte Order	Sign	Value
1	milesight	1	0	1	Holding Register(INT32)	CDAB	<input type="checkbox"/>	<input type="checkbox"/>

ff 15 00		
Channel	Type	Value
ff	15 (Poll Failed)	00 => Channel 1

5.3 Downlink Command

UC100 supports downlink commands to configure the device. The application port is 85 by default.

Channel	Type	Description
ff	03(Set Reporting Interval)	2 Bytes, unit: s
	10 (Reboot)	ff (Reserved)

Examples:

1. Reporting Interval

ff 03 b0 04		
Channel	Type	Value
ff	03 (Set Reporting Interval)	b0 04 => 04 b0 = 1200 s = 20 mins

2. Reboot the device

ff 10 ff		
Channel	Type	Reserved
ff	10 (Reboot)	ff

-END-