



AI Workplace Sensor

Featuring LoRaWAN®

VS121

User Guide



Safety Precautions

Milesight will not shoulder responsibility for any loss or damage resulting from not following the instructions of this operating guide.

- ❖ The device must not be disassembled or remodeled in any way.
- ❖ To avoid risk of fire and electric shock, do keep the product away from rain and moisture before installation.
- ❖ Do not place the device where the temperature is below/above the operating range.
- ❖ Do not touch components which may be hot.
- ❖ The device must never be subjected to shocks or impacts.
- ❖ Make sure the device is firmly fixed when installing.
- ❖ Make sure the plug is firmly inserted into the power socket.
- ❖ Do not expose the device to where a laser beam equipment is used.
- ❖ Use a soft, dry cloth to clean the lens of the device. Stubborn stains can be removed using a cloth dampened with a small quantity of detergent solution, then wipe them dry.

Declaration of Conformity

VS121 is in conformity with the essential requirements and other relevant provisions of the CE, FCC, and RoHS.

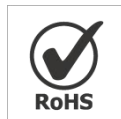

Copyright © 2011-2022 Milesight. All rights reserved.

All information in this guide is protected by copyright law. Whereby, no organization or individual shall copy or reproduce the whole or part of this user guide by any means without written authorization from Xiamen Milesight IoT Co., Ltd.

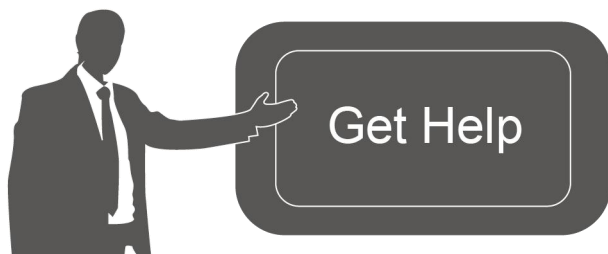

For assistance, please contact

Milesight technical support:

Email: iot.support@milesight.com

Tel: 86-592-5085280

Fax: 86-592-5023065

Address: Building C09, Software Park
Phase III, Xiamen 361024,
China

Revision History

Date	Doc Version	Description
Apr. 26, 2021	V 1.0	Initial version
Jan. 18, 2022	V 1.1	<ol style="list-style-type: none">1. Support line crossing counting feature;2. Support LoRa D2D feature;3. Support people counting debounce;4. Support uploading max number of people;5. Support downlink control.

Contents

1. Product Introduction.....	5
1.1 Overview.....	5
1.2 Key Features.....	5
2. Hardware Introduction.....	5
2.1 Packing List.....	5
2.2 Hardware Overview.....	6
2.3 Buttons and LED Indicators.....	6
2.4 Dimensions.....	6
3. Access the Sensor.....	7
3.1 Access without Plugin.....	7
3.2 Access with Plugin.....	8
4. Operation Guide.....	10
4.1 Live Video.....	10
4.2 IoT.....	11
4.2.1 Region People Counting.....	11
4.2.2 Line Crossing Counting.....	12
4.2.3 LoRa.....	13
4.2.4 Wi-Fi.....	15
4.3 Advanced Settings.....	17
4.3.1 Security.....	17
4.3.2 Logs.....	18
4.4 System.....	19
4.5 Maintenance.....	19
4.5.1 System Maintenance.....	19
4.5.2 Auto Reboot.....	20
5. Installation.....	21
6. Device Payload.....	21
6.1 Uplink Data.....	22
6.2 Downlink Command.....	23

1. Product Introduction

1.1 Overview

VS121, based on Artificial Intelligence (AI) technology, is an AI workplace sensor designed to monitor occupancy & utilization in modern workspace, which can reach up to 95% recognition rate. With the ability to sense from up to 78m², fewer sensors are needed to cover the same area, decreasing the deploy costs for users. Only counter values are transmitted over LoRaWAN[®] network to prevent the privacy concerns. VS121 is equipped with Wi-Fi for easy configuration without any tools.

Sensor data are transmitted in real-time using standard LoRaWAN[®] protocol. LoRaWAN[®] enables encrypted radio transmissions over long distance while consuming very little power. The user can obtain sensor data and view the trend of data change through the user's own network server.

1.2 Key Features

- Recognition rate is up to 95% based on advanced AI identification and analysis technology and wide detection range
- Support to map up to 12 custom regions
- No image data is collected, free from privacy concerns
- Equipped with Wi-Fi for web GUI configuration
- Function well with standard LoRaWAN[®] gateways and network servers

2. Hardware Introduction

2.1 Packing List

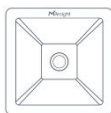

1 × VS121 Device



4 × Wall Mounting
Kits



1 ×
Type-C Cable (1 m) &
Power Adapter

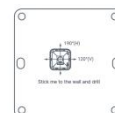

1 ×
Mounting Sticker



1 ×

Warranty Card



1 ×

Quick Guide



If any of the above items is missing or damaged, please contact your sales representative.

2.2 Hardware Overview

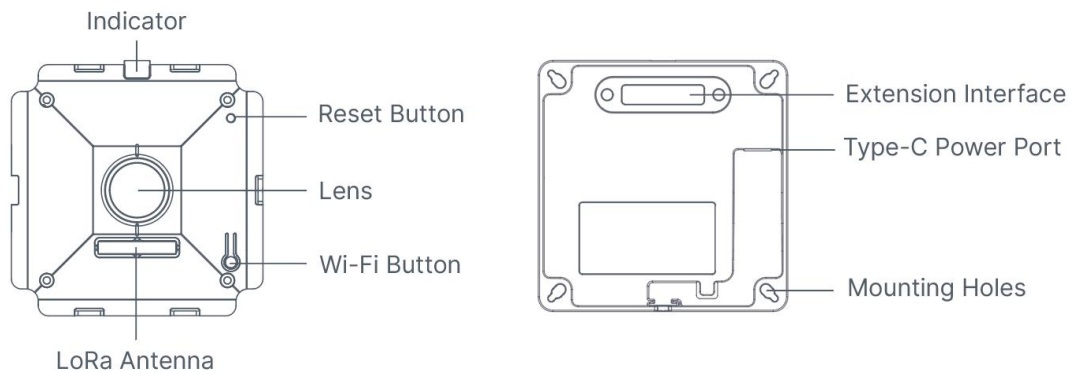

2.3 Buttons and LED Indicators

Function	Action	LED Indication
Turn On/Off Wi-Fi	Press and hold the Wi-Fi button for more than 3 seconds.	Off → On
	Press and hold the Wi-Fi button for more than 3 seconds.	On → Off
Reset to Factory Default	Press and hold the reset button for more than 10 seconds.	Blinks 6 times.

2.4 Dimensions (mm)

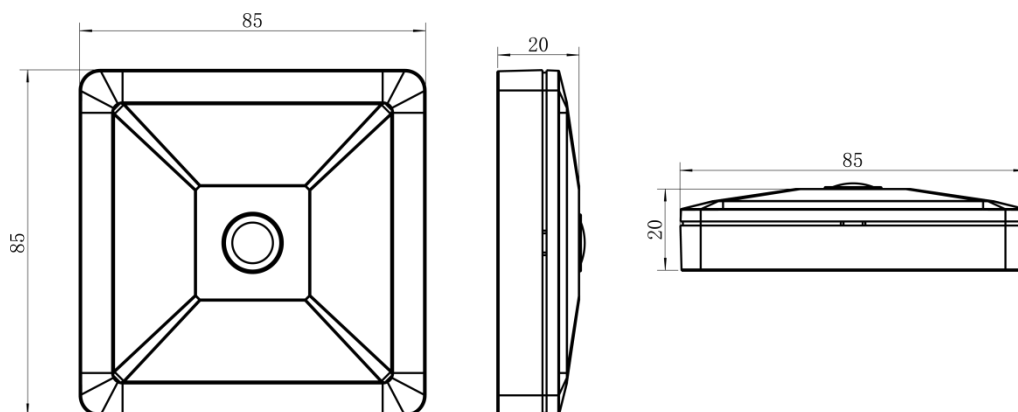

3. Access the Sensor

VS121 sensor provides user-friendly web GUI for configuration and users can access it via Wi-Fi connection. The recommended browsers are Internet Explorer, Firefox, Chrome, Microsoft Edge, Safari. The default IP of sensor is 192.168.1.1, and default SSID is Vision Sensor_XXXXXX (can be found on the label).

3.1 Access without Plugin

Step 1: Power on the device.

Step 2: Enable the Wireless Network Connection on your computer and search for corresponding access point, then connect computer to this access point.

Step 3: Open the Browser and type 192.168.1.1 to access the web GUI.

Step 4: Select the language.

Step 5: Users need to set the password when using the sensor for the first time. And three security questions can also be set optionally. After configuration, use username (admin) and custom password to log in the sensor.

Note:

- 1) Password must be 8 to 32 characters long, contains at least one number and one letter.
- 2) You can click the "forgot password" in login page to reset the password by answering three security questions when you forget the password, if you set the security questions in advance.

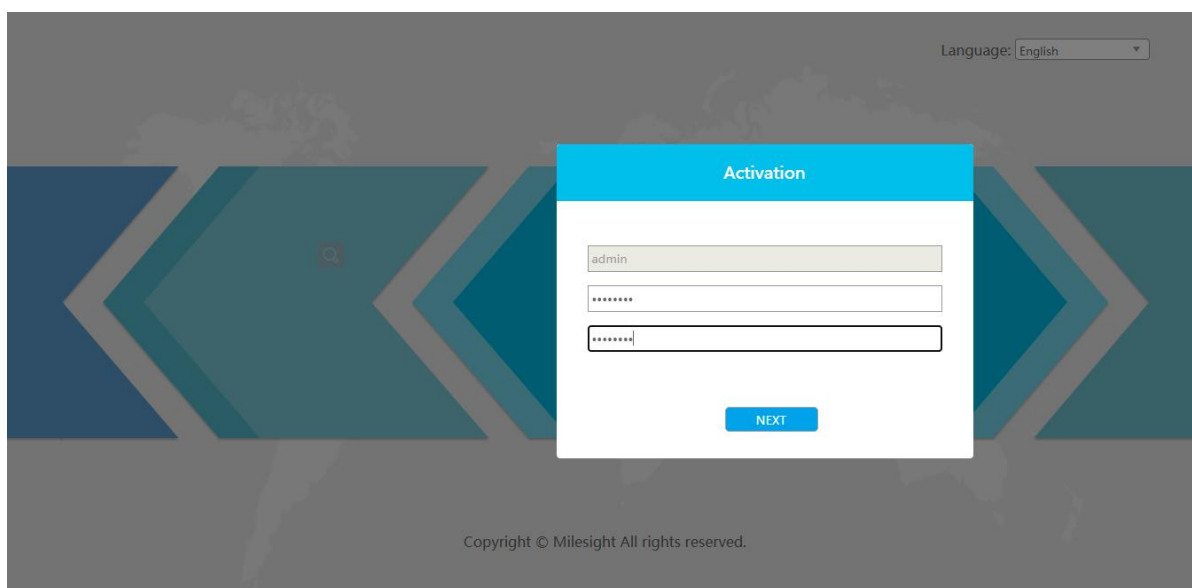

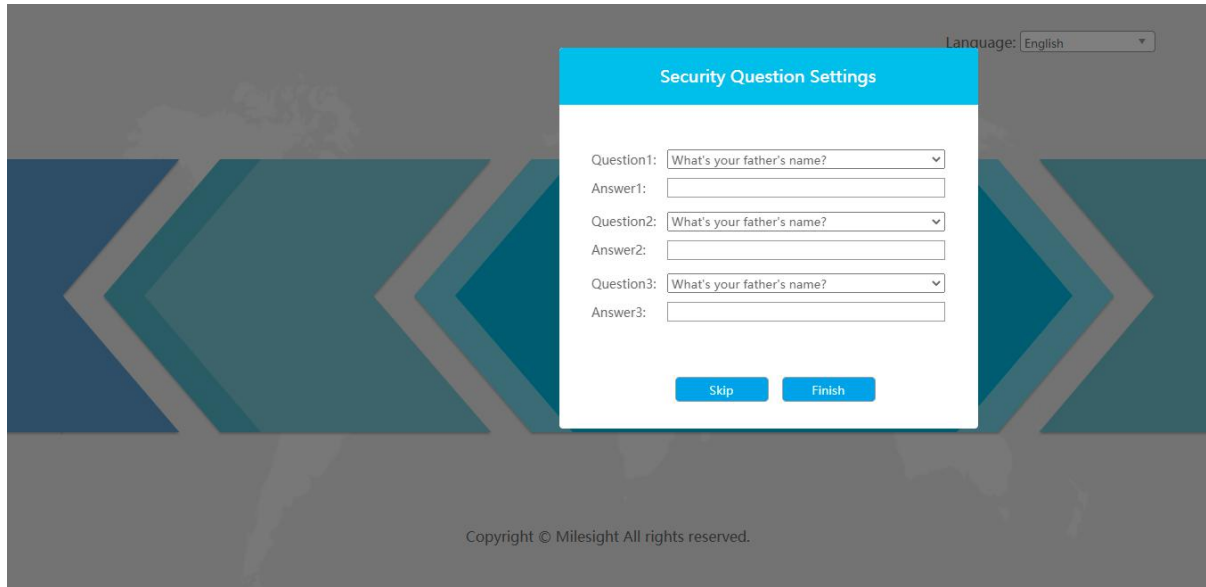

3.2 Access with Plugin

For IE browser access, users need to install the MsActiveX firstly. You can refer the steps as follows:

Step1: Launch the IE browser and enter the IP address of the sensor;

Step2: Enter the user name and custom password and click "Login";

Step3: At the first time to log in the device, the browser will prompt to install Controls, please click "Click here to download and install controls manually" as shown below;

Click here to download and install controls manually

Note: During installing the controls, please keep the browsers close.

Step4: Follow the prompts to install the Controls, when it's finished, it will pop out a window as shown below. Please click "Finish" and refresh the browser, then you will see the video.

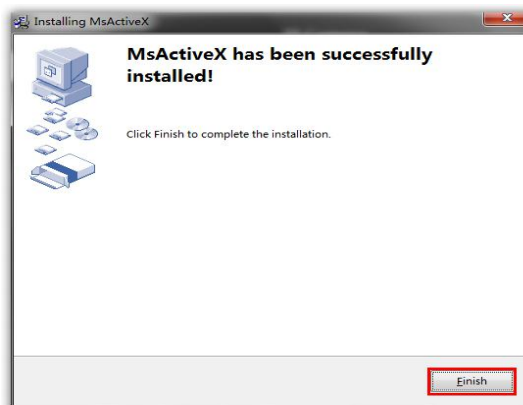

If IE9 or higher version browser is used, it is suggested that the web link should be added as a trusted site. See the instructions as follows:

Step1: Start the IE9 or higher version browser, and select "Tools" → "Internet Options";

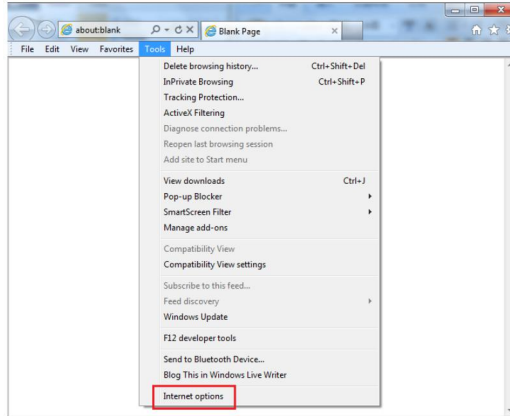

Step2: Select "Security" to "Trusted";

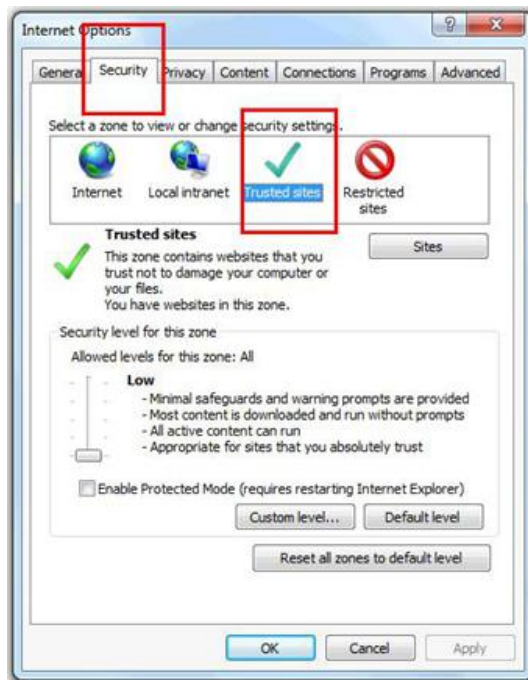

Step3: Enter the IP address of the device in the blank and click "Add";

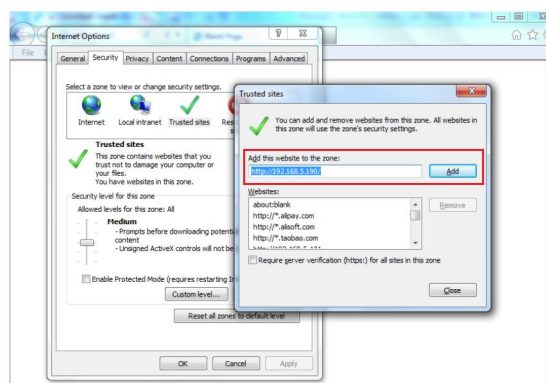





Step4: Enter the IP address. After logging on web GUI successfully, user is allowed to view live video.

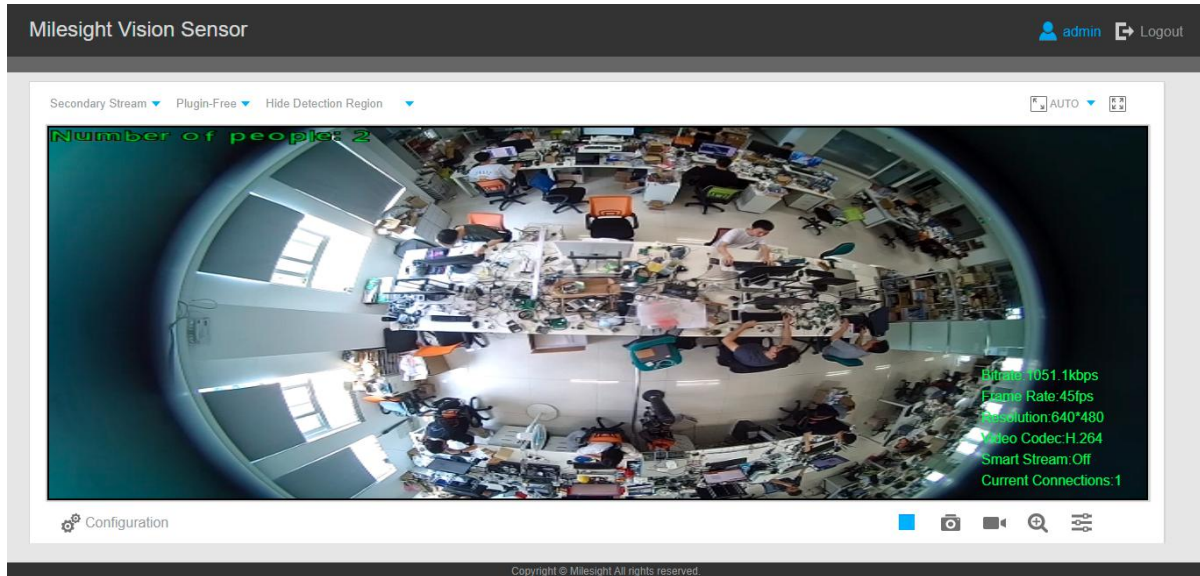

4. Operation Guide

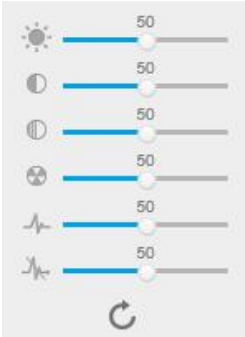
4.1 Live Video

After logging on to the device web GUI successfully, user is allowed to view live video as follows.



Parameters	Description
 <p>Image Config</p>	<p>Brightness: Adjust the Brightness of the scene</p> <p>Contrast: Adjust the color and light contrast</p> <p>Saturation: Adjust the Saturation of the image. Higher Saturation makes colors appear more "pure" while lower one appears more "wash-out"</p> <p>Sharpness: Adjust the Sharpness of image. Higher Sharpness sharpens the pixel boundary and makes the image looks "more clear"</p> <p>2D DNR/3D DNR: Adjust the noise reduction level</p> <p>Default: Restore brightness, contrast and saturation to default settings</p>
 Configuration	Click to access the configuration page
Hide Detection Region ▼	<p>People Counting (Region): show the mapped or non-mapped regions of people counting</p> <p>Line Crossing Counting: show the detection line and people it detected</p> <p>Hide Detection Region: hide people detection region</p>
 AUTO	Click to display images at a window size
 100%	Click to display images at a real size

 Full Screen	Click to display images at full-screen
	Start/Stop live view
 Enable Digital Zoom	When enabled, you can zoom in in a specific area of video image with your mouse wheel

4.2 IoT

4.2.1 Region People Counting

Users can set the report settings and detection regions here.

IoT

Region People Counting
Line Crossing Counting
LoRa
Wi-Fi

Enable:	<input checked="" type="checkbox"/>
Number of People:	1
Settings	
Report Regularly:	<input checked="" type="checkbox"/>
Reporting Interval (s):	<input type="text" value="300"/>
Report by Result:	<input checked="" type="checkbox"/>
Mode:	<input type="text" value="Once result changes"/>
Debounce Time:	<input checked="" type="checkbox"/>
Set Detection Region	
Enable:	<input checked="" type="checkbox"/>
Detection Area:	<input type="text" value="Non-mapped Region"/>

Number of people: 1

Parameters	Description
Enable	Enable or disable region people counting feature.
Number of People	Show current number of people.
Report Regularly	Report the current number of people according to reporting interval. Reporting Interval: 5-3600s, default: 300 s
Report by Result	Report according to following people number results: <ul style="list-style-type: none"> ● Zero and Non-zero ● Once result changes
Debounce Time	VS121 will reduce the count value only the people come out of the detection area for more than 2 s.

Enable	Enable the detection area customization feature. If disabled, the whole area will be detection area.
Detection Area	Select the customized area as either mapped or except mapped area. You can draw the area in the below screen. 12 regions can be set at most. Mapped Region: Only people who are in the mapped region will be detected. Non-mapped Region: Only people who are not in the mapped region will be detected.
Clear	Clear all areas you have drawn before.

4.2.2 Line Crossing Counting

When the sensor detected the people crossing a defined virtual line, it will upload the counting.

IoT >> MenuIoT

Region People Counting

Line Crossing Counting

LoRa

Wi-Fi

Enable:

Reporting Interval (s):

[Set Detection Line](#)



Parameters	Description
Enable	Enable or disable line crossing counting feature.
Reporting Interval	Report the count value of people in/out during the reporting interval, the device will clean the previous values to re-count after reported, range: 5-3600 s, default: 300 s
Set Detection Line	The device allows to set up only one line. For the detection line, crossing along the direction of the arrow means "In" and opposite is "Out".
Clear	Clear the line you have drawn before.

Note: the arrow direction of the detection line depends on the direction of your draw.



4.2.3 LoRa

LoRa settings is used for configuring the transmission parameters in LoRaWAN® network or LoRa D2D network.

4.2.3.1 Basic Settings

IoT

Region People Counting Line Crossing Counting LoRa Wi-Fi

Status:	Activated
Basic Settings	
Device EUI:	24E124600B230584
App EUI:	<input type="text" value="24E124C0002A0001"/>
Join Type:	<input type="text" value="OTAA"/>
Application Key:	<input type="text" value="*****"/>
RX2 Data Rate:	<input type="text" value="DR8 (SF12, 500k)"/>
RX2 Frequency/MHz:	<input type="text" value="923.3"/>
Advanced Settings	
Confirmed Mode:	<input type="checkbox"/>
ADR:	<input checked="" type="checkbox"/>
Rejoin Mode:	<input checked="" type="checkbox"/>
LinkCheckReq Message Retries:	<input type="text" value="8"/>
Port:	<input type="text" value="85"/>
Spreading Factor:	<input type="text" value="SF12-DR0"/>
LoRaWAN Version:	<input type="text" value="V1.1.0"/>
Region:	<input type="text" value="US915"/>
Channel:	<input type="text" value="0-71"/>
Index	Frequency/MHz
0-15	902.3-905.3

Parameters	Description
Status	LoRaWAN® network status of this device.
Device EUI	Unique ID of the device which can also be found on the label.
App EUI	Default App EUI is 24E124C0002A0001.
Join Type	OTAA and ABP mode are available.

Application Key	Appkey for OTAA mode, default is 5572404C696E6B4C6F52613230313823.
Device Address	DevAddr for ABP mode, default is the 5 th to 12 th digits of SN.
Network Session Key	Nwkskey for ABP mode, default is 5572404C696E6B4C6F52613230313823.
Application Session Key	Appskey for ABP mode, default is 5572404C696E6B4C6F52613230313823.
RX2 Data Rate	RX2 data rate to receive downlinks or send LoRa D2D command.
RX2 Frequency/MHz	RX2 frequency to receive downlinks or send LoRa D2D command.
Confirmed Mode	If the device does not receive ACK packet from network server, it will resend data 3 times at most.
ADR Mode	Allow network server to adjust data rate of the device.
Rejoin Mode	Reporting interval \leq 30 mins: the device will send specific mounts of LoRa MAC packets to check connection status every 30 mins; If no reply after specific packets, the device will re-join. Reporting interval $>$ 30 mins: the device will send specific mounts of LoRaMAC packets every to check connection status every reporting interval; If no reply after specific packets, the device will re-join.
Application Port	The port used for sending and receiving data, default port is 85.
Spreading Factor	If ADR is disabled, the device will send data via this spreading factor.
LoRaWAN Version	V1.0.2, V1.0.3, V1.1.0 are available.
Region	Frequency plan of this device.
Channel	Enter the index to select the frequency channel. Examples: 1, 40: Enabling Channel 1 and Channel 40 1-40: Enabling Channel 1 to Channel 40 1-40, 60: Enabling Channel 1 to Channel 40 and Channel 60 All: Enabling all channels Null: Indicates that all channels are disabled

Note:

- 1) Please contact sales for device EUI list if there are many units.
- 2) Please contact sales if you need random App keys before purchase.
- 3) Only OTAA mode supports rejoin mode.
- 4) For -868M model, default frequency is EU868; for -915M model, default frequency is AU915.

4.2.3.2 LoRa D2D Settings

LoRa D2D protocol is developed by Milesight and used for setting up transmission among Milesight LoRa devices without gateway. When the LoRa D2D setting is enabled, VS121 can work as a LoRa D2D controller for sending control commands to trigger LoRa D2D agent devices.

LoRa D2D Settings	
Enable D2D	<input checked="" type="checkbox"/>
LoRa D2D Key	*****
Control Settings	
Condition 1	Occupied
Control Command 1	0000
Condition 2	Unoccupied
Control Command 2	0000

Parameters	Description
Enable D2D	Enable or disable LoRa D2D feature.
LoRa D2D Key	Define a unique LoRa D2D key and this key is the same as the setting in LoRa D2D agent device. Default value: 5572404C696E6B4C6F52613230313823
Condition	Occupied: when total people counter value is non-zero in detection area Unoccupied: when total people counter value is 0 in detection area
Control Command	Define a 2-byte hexadecimal control command (0x0000 to 0xffff). When the condition is meet, the device will send the control command to corresponding LoRa D2D agent devices.

Note: When this feature is enabled, the control command from this device will not send to LoRaWAN® gateway.

4.2.4 Wi-Fi

IoT

Region People Counting

Line Crossing Counting

LoRa

Wi-Fi

Enable:	<input checked="" type="checkbox"/>
Work Mode:	AP
SSID:	<input type="text" value="Vision Sensor_F24B95"/>
Protocol:	<input type="text" value="802.11n (2.4G)"/>
Bandwidth:	<input type="text" value="20MHz"/>
Channel:	<input type="text" value="auto"/>
Security Mode:	<input type="text" value="No Encryption"/>
DHCP Server Settings:	
LAN IP Address:	<input type="text" value="192.168.1.1"/>
Netmask:	<input type="text" value="255.255.255.0"/>
Start Address:	<input type="text" value="192.168.1.100"/>
End Address:	<input type="text" value="192.168.1.199"/>
Lease Time (min):	<input type="text" value="1440"/>
Primary DNS Server:	<input type="text" value="114.114.114.114"/>
Secondary DNS Server:	<input type="text" value="8.8.8.8"/>
Static IP	
MAC Address	IP Address
<input type="text"/>	<input type="text"/>
	<input type="button" value="x"/>
	<input type="button" value="+"/>

Parameters	Description
Enabled	Enable Wi-Fi feature.
Work Mode	Work mode is fixed as AP and can not connect to other access point.
SSID	The unique name for this device Wi-Fi access point.
Protocol	802.11b (2.4 GHz), 802.11g (2.4 GHz), 802.11n (2.4 GHz) are optional.
Bandwidth	20 MHz or 40 MHz are optional.
Channel	Select the wireless channel. Auto, 1,...11 are optional.
Security Mode	No Encryption, WEP Open System, WEP Shared Key, WPA-PSK, WPA2-PSK and WPA-PSK/WPA2-PSK are optional.
DHCP Server Settings	LAN IP Address: IP address that used to access the web GUI of sensor.
	Subnet mask: identify the subnet where the sensor is located.
	Start Address: define the beginning of IP address pool which assigns to DHCP clients.
	End Address: define the end of IP address pool which assigns to DHCP clients.
	Lease Time (min): the lease time on which DHCP client can use the IP address assigned by the sensor.
	Primary DNS Server: translate the domain name to IP address.
	Secondary DNS Server: backup DNS server.

Static IP Settings	Add MAC address and static IP address if users need to add a static IP address to a specific computer.
--------------------	--

4.3 Advanced Settings

4.3.1 Security

User

Security Question

Security Question: Edit

Account Management

Add
Edit
Delete

ID	User Name	Privilege
1	admin	Administrator

Admin Password:

User Level:

User Name:

Password:

Confirm:

Parameters	Description
Security Question	<p>Click Edit button to set three security questions for your device. In case that you forget the password, you can click Forget Password button on login page to reset the password by answering three security questions correctly.</p> <div style="border: 1px solid #ccc; padding: 10px; margin: 10px 0;"> <div style="text-align: center; background-color: #e1f5fe; padding: 5px;">Security Question Settings</div> <p>Admin Password: <input type="password"/></p> <p>Security Question1: <input type="text" value="What's your father's name?"/></p> <p>Answer1: <input type="text"/></p> <p>Security Question2: <input type="text" value="What's your father's name?"/></p> <p>Answer2: <input type="text"/></p> <p>Security Question3: <input type="text" value="What's your father's name?"/></p> <p>Answer3: <input type="text"/></p> <p style="text-align: center; margin-top: 10px;">Save</p> </div> <p>There are twelve default questions below, you can also customize the security questions.</p>

	<div style="border: 1px solid black; padding: 5px;"> <p>What's your father's name?</p> <p>What's your favorite sport?</p> <p>What's your mother's name?</p> <p>What's your mobile number?</p> <p>What's your first pet's name?</p> <p>What's your favorite book?</p> <p>What's your favorite game?</p> <p>What's your favorite food?</p> <p>What's your lucky number?</p> <p>What's your favorite color?</p> <p>What's your best friend's name?</p> <p>Where did you go on your first trip?</p> <p>Customized Question</p> </div>
<p>Account Management</p>	<p>Click Add button, it will display Account Management page. Users can add an account by entering Admin Password, User Level, User Name, New Password, Confirm, and edit user privilege by clicking <input type="checkbox"/>. The added account will be displayed in the account list. Users can add 20 accounts at most.</p> <p>Admin Password: enter the correct admin password before adding an account.</p> <p>User Level: Set the privilege for the account.</p> <p>User Name: Input user name for creating an account.</p> <p>Password: Input password for the account.</p> <p>Confirm: Confirm the password.</p> <p>You can edit and delete the account in the account list under the admin account. For the default admin account, you can only change the password, and it cannot be deleted.</p>

4.3.2 Logs

The logs contain the information about the time and IP that has accessed the web GUI.

Show entries

Time	Main Type	Sub Type	Param	User	IP	Detail	Log Search
1969-12-31 18:06:37	Operation	Login Remotely	-	admin	192.168.1.101		<p>Main Type: <input type="text" value="All Types"/></p> <p>Sub Type: <input type="text" value="All Types"/></p> <p>Start Time: <input type="text" value="1969-12-31 00:00:00"/></p> <p>End Time: <input type="text" value="1969-12-31 23:59:59"/></p> <p><input type="button" value="Search"/></p> <p><input type="button" value="Log Export"/></p> <p>Save Period: <input type="text" value="Permanent"/></p> <p><input type="button" value="Save"/></p>
1969-12-31 18:06:30	Operation	Logout Remotely	-	admin	192.168.1.101		
1969-12-31 18:06:12	Operation	Logout Remotely	-	admin	192.168.1.101		
1969-12-31 18:03:52	Operation	Login Remotely	-	admin	192.168.1.101		
1969-12-31 18:03:42	Operation	Logout Remotely	-	admin	192.168.1.101		
1969-12-31 18:02:22	Operation	Config Remotely	Date&Time	admin	192.168.1.101		
1969-12-31 17:52:47	Operation	Login Remotely	-	admin	192.168.1.101		
1969-12-31 17:52:35	Operation	Logout Remotely	-	youny2	192.168.1.101		
1969-12-31 17:52:14	Operation	Login Remotely	-	youny2	192.168.1.101		
1969-12-31	Operation	Logout Remotely	-	younv	192.168.1.101		

Showing 1 to 30 of 154 entries First Previous **1** 2 3 4 5 6 Next Last

Parameters	Description
Main Type	Select main log types

Sub Type	On the premise of main type has been selected, select the sub type to narrow the range of logs
Start Time	The time of the log starts
End Time	The time of the log ends
Log Export	Export the logs
Save Period	Set the period of log saving, there are eight options to choose: Permanent and 30/60/120/180/240/300/360 Days
Go	Input the number of logs' page

4.4 System

All information about the hardware and software can be checked on this page.

System	
Device Name:	<input type="text" value="Vision Sensor"/>
Product Model:	VS121-470M
SN:	6600B2365930
Hardware Version:	V1.1
Software Version:	31.7.0.76-iot2
MAC Address:	24:E1:24:F2:4B:95

4.5 Maintenance

4.5.1 System Maintenance

Maintenance

System Maintenance
Auto Reboot

System Upgrade

Software Version: 31.7.0.75-iot2-a6

Local Upgrade: No file chosen
 Reset after Upgrading

Online Upgrade:

Note: Do not disconnect the power of the device during the upgrade.

Maintenance

Reset Keep the IP Configuration Keep the User Information

Export Config File:

Config File: No file chosen

Import Config File:

Reboot

Reboot the Device:

Parameters	Description
System Upgrade	<p>Software Version: The software version of the sensor.</p> <p>Local Upgrade: Click the Choose File button and select the upgrading file, then click the Upgrade button to upgrade. After the system reboots successfully, the update is done.</p> <p>You can check Reset after Upgrading to reset the device after upgrading it.</p> <p>Note: Do not disconnect the power of the device during the upgrade process. The device will be restarted to complete the upgrading.</p>
Maintenance	<p>Reset settings: Click Reset button to reset the device to factory default settings</p> <p>Keep the IP Configuration: Check this option to keep the IP configuration when resetting</p> <p>Keep the User Information: Check this option to keep the user information when resetting</p> <p>Export Config File: Export configuration file.</p> <p>Import Config File: Click the Choose File button and select the configuration file, click Import button to import configuration file.</p>
Reboot	Restart the device immediately

4.5.2 Auto Reboot

Set the date and time to enable device auto reboot, the device will reboot automatically according to the customized time in case that sensor overload after running a long time. Before configuration note that the date and time should correct.

Auto Reboot Settings

Enable Auto Reboot:

Day: Everyday ▼

Time: 00:00:00 📅

Save

5. Installation

Step 1: Ensure the thickness of ceiling is more than 30 mm, then attach the mounting sticker to the ceiling and drill 4 holes with a diameter of 6 mm.

Step 2: Fix the wall plugs into the ceiling holes.

Step 3: Remove the cover on the device, then fix the device to the wall plugs via mounting screws; remember to adjust the mounting direction according to the detection area requirement and direction sticker on the inner cover.

Step 4: Take the cover back to device; note that the Milesight Logo should be facing the LED indicator.

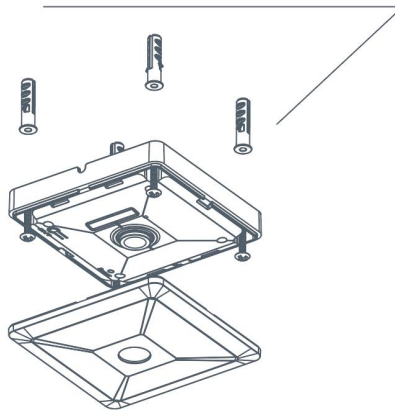

6. Device Payload

VS121 reports basic information only when joining the network and reports people counter according to reporting settings. All data are based on following format(HEX):

Channel1	Type1	Data1	Channel2	Type2	Data2	Channel 3	...
1 Byte	1 Byte	N Bytes	1 Byte	1 Byte	M Bytes	1 Byte	...

For decoder examples please find files on <https://github.com/Milesight-IoT/SensorDecoders>.

6.1 Uplink Data

VS121 report basic information of sensor whenever joining the network and the number of people according to settings.

Channel	Type	Description
ff	01(Protocol Version)	01=> V1
	08 (Device SN)	12 digits
	09 (Hardware Version)	01 04 => V1.4
	1f (Software Version)	1f 07 00 4b => V31.7.0.75
04	c9 (Region People Counter)	<p>Byte 1: current total number of people</p> <p>Byte 2: how many mapped regions is customized</p> <p>Byte 3-4: indicate which mapped regions having detected people, 0 means no people detected, 1 means there are people detected in this mapped region</p>
05	cc (Line Cross Counter)	<p>Byte 1-2: in counter during the report interval</p> <p>Byte 3-4: out counter during the report interval</p>
06	cd (Max People Counter)	<p>Maximum number of people in detection area during the reporting interval of region people counting.</p> <p>Note: this value only update when you enable "Report Regularly" option.</p>

Example:

1. Device information

ff0101 ff086600b0940976 ff090100 ff1f1f07004b					
Channel	Type	Value	Channel	Type	Value
ff	01 (Protocol Version)	01 (V1)	ff	08 (Device SN)	66 00 b0 94 09 76
Channel	Type	Value	Channel	Type	Value
ff	09 (Hardware version)	0100 (V1.0)	ff	1f (Software version)	1f 07 00 4b (V31.7.0.75)

2. Region people counter regular uplink

04c9030800a1 06cd05		
Channel	Type	Value
04	c9 (Region People Counter)	Byte 1: 03 => There are 3 people totally now Byte 2: 08 => there are 8 mapped regions Byte 3-Byte 4: 00 a1=>1010 0001 there are people detected in region 1, 6 and 8
Channel	Type	Value
06	cd (Max People Counter)	05 => during the reporting interval, the maximum number of people is 5

3. Line cross counter

05cc02000100		
Channel	Type	Value
05	Cc (Line Crossing Counter)	In: 02 00 => 00 02 = 2 Out: 01 00 => 00 01 = 1

6.2 Downlink Command

VS121 supports downlink commands to configure the device. Application port is 85 by default.

Channel	Type	Description
ff	10 (Reboot)	ff (Reserved)
	04 (Confirmed Mode)	00: disable, 01: enable
	05 (Change LoRa Channel Mask)	Byte 1: Channel index range 01: 0-15 02: 16-31 03: 32-47 04: 48-63 05: 64-79 06: 80-95 Byte 2-3: indicate disable or enable via every bit, 0=disable, 1=enable
	40 (ADR)	00: disable, 01: enable
	41 (Configure Application Port)	1 Byte, default is 85
	42 (Wi-Fi)	00: disable, 01: enable
	50 (Region People Counting)	00: disable, 01: enable

43 (Region People Counting Report Regularly)	00: disable, 01: enable
44 (Region People Counting Report by Result)	00: disable, 01: enable
45 (Report by Result Mode)	00: Zero and Non-zero 01: Once result changes
48 (Line Crossing Counting)	00: disable, 01: enable

Note: after changing LoRa setting, the device will re-join the network.

Example:

1. Disable the Wi-Fi.

ff4200		
Channel	Type	Value
ff	42 (Wi-Fi)	00: disable

2. Set AU915 or US915 channel mask as 8-15.

ff0501ff00 ff05020000 ff05030000 ff05040000 ff05050000		
Channel	Type	Value
ff	05 (Set Channel Mask)	01: Channel index 0-15, ff00 => 8-15 is enabled 02-05: Channel index 16-79, 0000 => all disabled

3. Reboot the device.

ff10ff		
Channel	Type	Value
ff	10 (Reboot)	ff (Reserved)

-END-